



# **USER'S MANUAL**

## **SB200 Series Inverter**

**High Performance General Space Vector Control**

**Input: 3 Phase 400v class**

**Capacity: 1.5 ~ 400kw**

**Version 1.3**

**Hope Senlan Science & Technology Holding Corp., Ltd.**

## Table of Contents

<b>PREFACE</b> .....	<b>1</b>
<b>1. NOTES ON SAFETY</b> .....	<b>3</b>
1.1. Notes on Safety .....	3
1.2. Caution: .....	4
<b>2. PRODUCT SPECIFICATION</b> .....	<b>8</b>
2.1. Universal Technical Specification of SB200 Inverter Series .....	8
2.2. Specification of the Inverter Series .....	10
<b>3. INSTALLATION AND WIRING</b> .....	<b>14</b>
3.1. Inverter Installation .....	14
3.2. Uninstallation/Installation of Inverter Components .....	15
3.3 Wiring of Inverter .....	17
3.4. Electromagnetic Interference Control Methods .....	23
<b>4. INVERTER OPERATION AND TRIAL OPERATION</b> .....	<b>26</b>
4.1. Inverter Operation and Display .....	26
4.2. Initial Energization .....	31
4.3. Guide to Quick Debugging .....	31
<b>5. LISTS OF FUNCTION PARAMETERS</b> .....	<b>33</b>
F0: Basic Parameters .....	33
F1: Acceleration/Deceleration, Startup, Shutdown and Jog Parameters .....	35
F2: V/F Control Parameters .....	37
F3. Motor Parameters .....	38
F4: Digital Input Terminals and Multi-Speed .....	38
F5: Settings of Digital Output and Relay Output .....	40
F6: Terminals Settings for Analog Quantities and Pulse Frequency .....	43
F7: PID Parameters .....	47
F8: Dedicated Water Supply Functions .....	48
F9: Time Management (Applicable to LCD Control Panel Only) .....	53
Fb: Protection Functions and Advanced Inverter Settings .....	54
FC: Keyboard Operation and Display Settings .....	58
FF: Communcation Parameters .....	59
Fn: Factory Settings .....	60
FP: Fault Logs .....	61
FU: Data Monitoring .....	63
<b>6. DETAILS ABOUT FUNCTION PARAMETERS</b> .....	<b>65</b>
6.1. F0: Basic Parameters .....	65
6.2. F1: Acceleration/Deceleration, Startup, Shutdown and Jog Parameters .....	69
6.3. F2: V/F Control Parameters .....	74
6.4. F3: Motor Parameters .....	79
6.5. F4: Digital Input Terminals and Multi-Speed .....	80
6.6. F5: Digital Output and Relay Output Settings .....	90
6.7 F6: Settings of Analog Quantities and Pulse Frequency Terminals .....	97

6.8 F7: PID Parameters.....	105
6.9. F8: Dedicated Water Supply Functions.....	111
6.10. F9: Time Management (Applicable to LCD Control Panel Only).....	123
6.11 Fb: Protection Functions and Advanced Inverter Settings.....	126
6.12 FC: Keyboard Operation and Display Settings.....	135
6.13 FF: Communication Parameters.....	138
6.14 FP: Fault Lists.....	147
6.15 FU: Data Monitoring.....	149
<b>7 SOLUTIONS TO FAULTS AND ABNORMALITIES .....</b>	<b>151</b>
7.1 Inverter Faults and Solutions.....	151
7.2 Inverter Alarms and Solutions.....	155
7.3. Inverter Operation Abnormalities and Solutions.....	157
<b>8. UPKEEP, MAINTENANCE AND AFTER-SALES SERVICE.....</b>	<b>159</b>
8.1. Daily Upkeep and Maintenance.....	159
8.2. Regular Maintenance.....	159
8.3. Replacement of Inverter Wearing Parts.....	160
8.4. Storage of Inverters.....	160
8.5. After-Sales Service.....	161
<b>9. OPTIONAL FITTINGS.....</b>	<b>162</b>
9.1 Braking Units.....	162
9.2 Communication Components.....	163
9.3 AC Reactor on the Input Side.....	163
9.4 EMI Filter and Ferrite Chip Common Mode Filter.....	163
9.5. Digital I/O Extension Board.....	163
9.6 Relay Extension Unit (SL-5X6T).....	164
9.7 Control Panel Complete with Parameter Copying (SB-PU70E).....	166
9.8 LCD Control Panel Complete with Parameter Copying (SB-PU 200; Simplified Chinese Version).....	166
9.9. Control Panel Mounting Box.....	171
<b>10. APPLICATION EXAMPLES.....</b>	<b>172</b>
10.1. Example 1: Two Variable-Frequency Cyclic Switchover Pumps (under Common Control) plus One Auxiliary Pump.....	172
10.2. Example 2: Constant Pressure Water Supply by Inverter plus Soft Starter.....	173
<b>11 VERSION INFORMATION.....</b>	<b>176</b>

**thanglongautomation.com - 0968.363.567**

## Preface

Thank you for selecting Senlan SB200 frequency inverter series. SB200 series integrate the optimized high-performance space vector control VVVF algorithm which supports numerous advanced functions, e.g. auto torque boost, slip compensation, oscillation suppression, tracking startup, stall prevention, precise deadband compensation, auto voltage stabilization, process identification and auto carrier frequency adjustment. With inbuilt constant pressure water supply and clock modules, the series are suitable for most industrial control applications.

This manual provides the user with a guide on installation & wiring, parameter setting, daily maintenance, fault diagnosis and troubleshooting. The user is required to peruse the whole content of the manual carefully and be familiarized with the relevant know-how and notes on inverter safety before any attempts of installation, setting, operation and maintenance.

The technical specifications applied to this product or the content of this manual may be subject to any change without prior notifying.

This manual is required to be kept properly until the inverter is out of its service life.

### Items to Be Checked on Opening the Packing Case

The user is required to carefully check and confirm the following items on opening the packing case. If you have any problem, don't hesitate to contact us or your supplier for a solution.

What to Confirm	How to Confirm
Is the inverter identical with the product you've ordered?	Check if the nameplate inscriptions on the side of the inverter comply with the requirements in your order
If there is any damages on the product?	Check the overall appearance of the product to see if there are any damages arising from transportation

Inverter Model Description

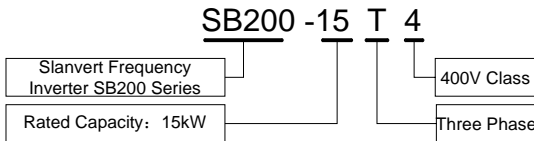

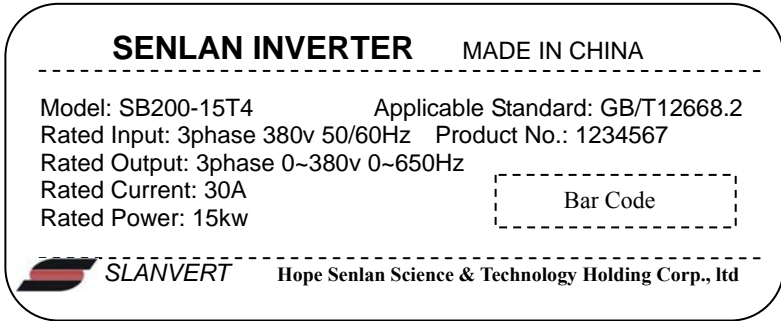

Inverter Nameplate Inscriptions (Instance: SB200-15T4)



#### Definition of Safety ID Markings

Any safety-specific content of this manual may use the following markings for identification. The user is required to follow the instructions of the content identified with safety markings.

 **CAUTION: Any wrong operation or against the instructions may cause inverter damage or personal injury/fatality.**

 **CAUTION: Any noncompliant operation may cause abnormal system operation which, in serious cases, may induce inverter damage or mechanical damage.**

## 1. Notes on Safety

### 1.1. Notes on Safety

#### (1) Installation

- The inverter must not be installed at places with combustibles or in the vicinity of combustibles; otherwise there may cause fire.
- The inverter must not be installed in an environment exposed to flammable gases; otherwise There may cause explosion.

#### (2) Wiring

- Confirm that the HV indicator lamp is thoroughly extinguished and the positive/negative busbar voltage is below 36V; otherwise there may be a risk of electric shock.
- Confirm that no wiring operation is permitted unless the power supply is thoroughly disconnected; otherwise there may be an electric shock hazard.
- Don't try to connect the DC terminals (P+/N-) directly with a dynamic braking resistor; otherwise there may be a fire hazard.
- The terminal voltage of the power supply must not exceed the rated voltage; otherwise there may be inverter damage.
- The earth terminal of the inverter must be properly and reliably earthed in compliance with the applicable national technical specifications; otherwise there may be an electric shock hazard;

#### (3) Inspection Prior to Connection to Power Supply

- Prior to connection to the power supply, remember to check that proper wiring is provided for the electrical peripherals, especially electrical circuits related to the safety of air circuit breakers and fault alarm devices.
- Prior to connection to the power supply, remember to close the cover of the inverter; otherwise there may be an electrical shock or explosion.
- The inverter provides control for high-speed operation of electric motors. If you intend to apply the inverter to a frequency above the rated motor frequency, you must confirm that the motor and the electrical parts can support high-speed operation.

#### (4) Notes on Connection to Power Supply and Operation

- Prior to a trial operation, check that all parameters are correctly set.
- The front cover must not be opened when the power supply is available, for the high voltage within may cause an electrical shock.
- Do not try to operate an inverter with wet hands; otherwise there may be an electrical shock.

- Factory settings for inverter self-start must be configured as “ALLOWED”. If terminal control is available and operation signals are effective, the inverter will self-start upon connection to the power supply.
- Do not try to start up or shut down the inverter by direct disconnection from the power supply.
- Reconfigure the relevant parameters after the execution parameters are initialized.
- After the restart function is selected (as in the event of a fault self-reset or a restart after instantaneous power failure), do not approach the electric motor or mechanical load while the inverter is ready for a startup.

(5) Notes on Transportation and Packaging

- Do not pile more inverters than allowed by the packing cases.
- Do not put weights on inverters.
- Do not leave the cover open while the inverters are in transit.
- Do not apply forces to the control panel or the cover while the inverters are being handled; otherwise personal injuries or property damage may occur.

(6) Disposal on Expiration of Service Life

- Dispose of the inverter as industrial waste.
- Explosions may occur if the electrolytic capacitor within the inverter is being burnt.
- Toxic gases may be emitted when the plastic parts of the inverter are burnt.

**1.2. Caution:**

(1) Ambient Conditions

- An SB200 inverter must be used in an environment conforming to the product specification; otherwise there may be a fault or shortened product life.

(2) Motor and Electrical Load

- Comparison with Line Frequency Operation

The SB200 series are PWM voltage inverters with a certain level of harmonics in output voltage. Compared with a line frequency power supply, the voltage loss, temperature rise and noise generated by a working motor are slightly higher.

If the voltage of the power supply is relatively high or the wiring of the motor extends a long distance, insulation strength of the cables and the motor must be taken into consideration.

- Constant-Torque Low-Speed Operation

When a conventional motor driven by an inverter is in prolonged low-speed operation, the motor temperature will rise because the heat dissipation effect of the motor becomes poorer. If

a prolonged constant-torque low-speed operation is required, a variable-frequency motor must be selected, or forced air cooling be provided.

- **Motor Overload Protection**

When an adapted motor is used, the inverter can provide overload protection for the motor. If the motor does not match the rated inverter capacity, adjust the parameters for protection, or take any other protection measure to ensure safe motor operation.

- **Operation at a Frequency above the Rated Motor Frequency**

If the motor runs at a frequency above the rated frequency, the user must confirm that the speed range of the motor bearing and mechanical parts supports the operation, in addition to motor vibration and noise increase.

- **Lubrication of Mechanical Devices**

Mechanical devices requiring lubrication, such as the gearbox and gears, may be damaged by deteriorating lubrication caused by prolonged low-speed operation. Confirm that prior to lubrication.

- **Regenerated Torque Load**

On such occasions as load elevation, there are frequent cases of regenerative torque, which may cause inverter shutdowns for overvoltage protection. Therefore, the user must consider selecting specific braking units of a proper specification.

- **Mechanical Resonance Points of Load-Carrying Devices**

Load-carrying devices may have mechanical resonance points that respond to the inverter in a specified output frequency range. The resonance effect may be dampened by installing vibration-resistant rubber pads under the base plate of the motor or avoided by configuring the avoidance frequency of the inverter.

- **Motor Insulation Check Prior to Connection to the Inverter**

The motor must be checked for insulation before a commissioning or operation after a longtime shutdown to prevent an inverter damage caused by deteriorated winding insulation. The insulation test must be aided with a 500V voltage-type megger. The measured insulation resistance must be at least 5MΩ. Do not use motors with poor insulation ratings. As the inverter provides power supply to the motor in a PWM mode, a poor insulation rating motor is susceptible to insulation damage.

### (3) Inverter

- **Capacitors or Pressure-Sensitive Elements to Improve Power Factor**

As the output voltage of the inverter is PWM voltage, any installation of power factor-improving capacitors or lightning protection pressure-sensitive resistors at the output terminal may induce inverter trip or element damage. Uninstall any such capacitor or resistor.

- Contactor, etc. Installed at the Output Terminal of the Inverter

If installation of contactors, etc. is required between the output terminal and the motor, please ensure that make-break operations are conducted when the inverter has no power output; otherwise the inverter may be damaged.

- Frequent Startup/Shutdown Operations

Control terminals are recommended for the startup/shutdown of the inverter. The user is absolutely not permitted to directly shut down or start up the inverter via such circuit-breakers as a contactor on the input terminal of the inverter.

- Application beyond the Rated Voltage

It is inadvisable to apply the SB200 inverter series to ranges beyond the permitted input voltage. If the user needs to apply the inverter to ranges beyond the rated voltage, please use a step-up or step-down transformer for transformation.

- Switching from 3-Phase Input to Single Phase Input

The change from 3-phase input to single phase input will augment the voltage/current ripples of the busbar. Ripples affect the service life of capacitors in the main circuit and deteriorate the performance of the inverter as well.

It is not recommended to switch to single-phase input. If a single-phase power supply is necessitated, the user must cancel phase-failure protection and reduce the ratings to a max of 60%. If a 30kW inverter or above requires to be changed to single phase input, ensure that the single-phase input terminal is connected to Terminals R and S, otherwise the inverter will fail to work.

- Lightning Surge Protection

The inverter has an inbuilt lightning overvoltage protector capable of self-protection against induced lightning shocks.

- Leakage Protector

Quick startups or shutdowns during inverter operation necessarily induce high-frequency leakage currents, which may sometimes cause misoperations of the leakage protection circuit. In the event of the aforesaid problems, reduce the carrier frequency and the length of the lead-in wire appropriately; besides, the leakage protector must be correctly installed.

Keep the following points in mind when installing a leakage protector:

- 1) It is more proper to install the protector at the input terminal of the inverter and behind the air circuit-breaker (not a fuse circuit-breaker).
- 2) The selected leakage protector must be insensitive to higher harmonics (sensitivity: Above 30mA) or specially suited for inverter applications. If a common leakage protector is selected, it must have sensitivity above 200mA and an action time above 0.1s.

- Inverter Derating

- 1) When the ambient temperature exceeds 40°C, the inverter must be derated by 5% for every

increment of one degree Celsius. Also, forced external heat dissipation must be provided.

- 2) At 1,000m above sea level, the thinner air will deteriorate the heat dissipation effect of the inverter. Therefore, the inverter must be derated by 1% for every increment of 100m.
- 3) When the set carrier frequency exceeds the factory settings, the inverter must be derated by 5% for every increment of 1kHz.

## 2. Product Specification

### 2.1. Universal Technical Specification of SB200 Inverter Series

Item		Description
Input	Rated Voltage/Frequency	3-phase, 380V; 50/60Hz
	Range	Voltage: 320-420V; voltage unbalance:<3 % ; frequency: 47-63Hz
Output	Output Voltage	3-phase; 0v-input voltage; error: below 5%
	Output Frequency	0.00-650.00Hz
	Overload Capacity	110% of rated current; 1 minute
	Frequency Resolution	Digital setting: 0.01Hz; analog setting: 0.1% of max frequency
	Output Frequency Accuracy	Analog setting: $\pm 0.2\%$ of max frequency ( $25\pm 10^{\circ}\text{C}$ ); digital setting: 0.01Hz ( $-10\text{---}+40^{\circ}\text{C}$ )
	Command Execution Channel	Settings may be configured via the control panel, control terminal or communication port. Switching is enabled via the terminal
	Frequency Setting Channel	Control panel, communication port, UP/DOWN adjustment, AI1, AI2, AI3 or PFI
	Auxiliary Frequency Setting	Flexible auxiliary frequency micro-adjustment and frequency setting synthesis
	Torque Elevation	Auto/manual torque elevation
	V/F Curve	Customizable V/F curves, linear V/F curves and 5 torque reduction characteristic curves
	Jogging	Jogging frequency range: 0.10-50.00Hz; jogging acceleration/deceleration time: 0.1-60.0s
	Auto Energy Saving	Load-based auto V/F optimization, capable of auto energy saving
	AVR	When the grid voltage fluctuates within a specified range, the inverter can automatically maintain a constant output voltage
	Auto Carrier Regulation	Auto carrier regulation based on load characteristics and ambient temperature
	Random PWM	Tone adjustment for an operating motor
	Instantaneous Power Failure Solution	Uninterrupted operation via busbar voltage regulation in the event of an instantaneous power failure
	DC Braking	Braking time: 0.0-60.0s; braking current: 0.0-100.0% of rated current
	PFI	Max input frequency: 50kHz
	PFO	Connector open circuit-type pulse square wave signal output; programmable
	Analog Input	3-channel analog signal input; options for voltage/current modes; capable of positive/negative input
	Analog Output	2-channel analog signal output; options for 0/4-20mA or 0/2-10V; programmable
	Digital Input	8-channel multifunctional digital input
	Digital Output	2-channel multifunctional collector open-circuit output; 5-channel multifunctional relay output
Communication	Inbuilt RS48S communication interface supporting Modbus protocol and USS commands	
Feature	Process Identification	Two PID parameter systems and multiple correction modes

Item		Description
	Water Supply Mode	Multiple water supply modes: fire water control, water injection control, clean water pool inspection, wastewater pool inspection, drainage pump control, sleeping, pump change at regular intervals and pump overhaul
	Custom Menu	30 user parameters can be customized
	Change of Parameter Display	Parameter display different from the factory settings is supported
	KWH Meter	Convenient for adjustment of the optimized energy saving schemes
Protection		Protection is available for overcurrent, overvoltage, undervoltage, input/output phase lack, output short-circuit, overheat, motor overload, external fault, analog input disconnection, stall prevention, etc.
Fittings		Braking units, extension cords for control panel, remote control box, digital I/O extension boards, relay extension boards, control panel capable of parameter copying (SB-PU70E) and LCD- display control panel (SB-PU200)
Environment	Application	Indoors; an elevation below 1,000m; away from exposure to direct sunlight, dust, corrosive gases, combustible gases, oil mist, water vapor, drippings and saline mist
	Ambient Temperature/Humidity	-10—+40℃/<90%RH; no condensate or dew
	Storage Temperature	-20—+60℃
	Vibration	Below 5.9m/s <sup>2</sup> (0.6g)
Structure	IP Rating	IP20
	Cooling Mode	Force air cooling with fan control

**2.2. Specification of the Inverter Series**

Refer to the following table for the ratings of the SB200 inverter series:

Model No.	Rated Capacity (kVA)	Common Application (110%I <sub>N</sub> every 10 minutes on every minute)		Heavy Load Application (150%I <sub>hd</sub> every 10 minutes on every minute)	
		Rated Output Current (A)	Adapted Motor (kW)	Rated Output Current (A)	Adapted Motor (kW)
SB200-1.5T4	2.4	3.7	1.5	3	1.1
SB200-2.2T4	3.6	5.5	2.2	3.7	1.5
SB200-4T4	6.4	9.7	4	5.5	2.2
SB200-5.5T4	8.5	13	5.5	9.7	4
SB200-7.5T4	12	18	7.5	13	5.5
SB200-11T4	16	24	11	18	7.5
SB200-15T4	20	30	15	24	11
SB200-18.5T4	25	38	18.5	30	15
SB200-22T4	30	45	22	38	18.5
SB200-30T4	40	60	30	45	22
SB200-37T4	49	75	37	60	30
SB200-45T4	60	91	45	75	37
SB200-55T4	74	112	55	91	45
SB200-75T4	99	150	75	112	55
SB200-90T4	116	176	90	150	75
SB200-110T4	138	210	110	176	90
SB200-132T4	167	253	132	210	110
SB200-160T4	200	304	160	253	132
SB200-200T4	248	377	200	304	160
SB200-220T4	273	415	220	377	200
SB200-250T4	310	475	250	415	220
SB200-280T4	342	520	280	475	250
SB200-315T4	389	590	315	520	280
SB200-375T4	460	705	375	590	315
SB200-400T4	490	760	400	705	375

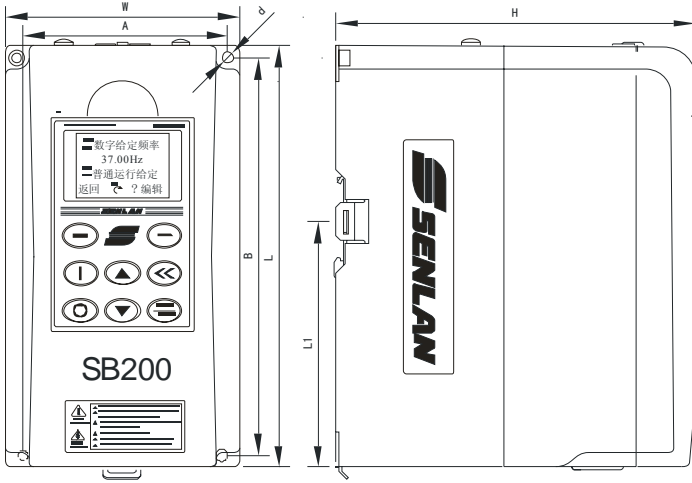

An Outline Drawing of the Inverter Series (SB200-1.5T4—5.5T4) (Installable with a standard DIN Guide Rail)



An Outline Drawing of the Inverter Series (SB200-7.5T4—22T4)

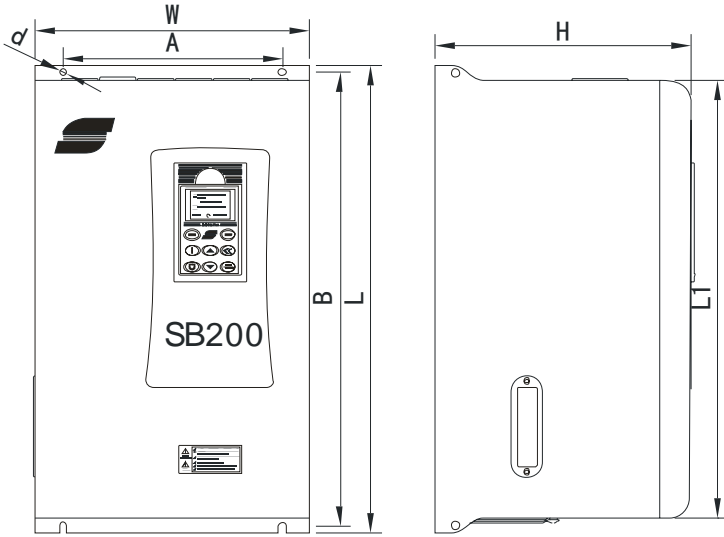

An Outline Drawing of the Inverter Series (SB200-30T4 and above)

Refer to the following table for the overall dimension and weight of the SB200 inverter series:

Model No.	W (mm)	L (mm)	L1 (mm)	H (mm)	A (mm)	B (mm)	D (mm)	Weight (kg)
SB200-1.5T4	100	180	105	157	87.5	170	Φ4.5	2
SB200-2.2T4								
SB200-4T4	135	240	140	170	125	230	Φ4.5	3
SB200-5.5T4								
SB200-7.5T4	150	300	—	195	138	288	Φ5.5	7
SB200-11T4								
SB200-15T4	200	380	—	225	185	367	Φ7	10
SB200-18.5T4								
SB200-22T4								
SB200-30T4	275	470	440	256	200	455	Φ8	
SB200-37T4								
SB200-45T4	280	570	520	290	200	550	Φ10	
SB200-55T4								
SB200-75T4	310	680	630	330	220	660	Φ10	
SB200-90T4								
SB200-110T4	350	800	750	330	220	780	Φ12	
SB200-132T4								
SB200-160T4	410	940	884	318	300	920	Φ12	
SB200-200T4								
SB200-220T4	500	1060	1000	355	320	1038	Φ12	
SB200-250T4								
SB200-280T4								
SB200-315T4	650	1180	1110	360	540	1152	Φ13	
SB200-375T4	650	1250	1180	360	540	1222	Φ13	
SB200-400T4								

### 3. Installation and Wiring

#### 3.1. Inverter Installation

CAUTION	<ol style="list-style-type: none"><li>1. The installation of the inverter may only be carried out by trained professionals.</li><li>2. Do not try to install a inverter if it is damaged or incomplete with any part; otherwise there may be hazards of fire or personal injuries.</li><li>3. Install the inverter where there is sufficient support for the inverter weight; otherwise there may be hazards of personal injuries or property damage in the event of a fall.</li><li>4. Do not apply forces to the control panel or the cover when handling the inverter; otherwise there may be hazards of personal injuries or property damage.</li></ol>
---------	---

The inverter must be installed in a room with sound ventilation. Keep the following points in mind when choosing a place of installation:

- (1) The ambient temperature must be controlled between -10°C and 40°C. As the inverter life is affected by the ambient temperature to a great extent, the user must ensure that the ambient temperature is within the tolerable range. When the temperature exceeds 40°C, the inverter must be derated by 5% for every increment of 1 degree Celsius. Besides, forced external heat dissipation must be provided.
- (2) At 1,000m above sea level, the thinner air will deteriorate the heat dissipation effect of the inverter. Therefore, it is necessary to derate the inverter by 1% for every increment of 100m.
- (3) The humidity must be lower than 90%RH and there must not be condensates or dews.
- (4) The inverter must be installed at a place where the vibration is less than 5.9m/s<sup>2</sup>(0.6g).
- (5) The inverter must be installed at a place away from exposure to direct sunlight.
- (6) The inverter must not be installed at a very dusty place or a place fraught with metal dust.
- (7) The user must not install the inverter at a place exposed to corrosive or combustible gases.
- (8) The inverter must be installed in a vertical way. Do not install it in an upside-down, slanted or horizontal way. Use proper screws to fix it onto a firm structure. Please refer to the following drawings for the requirements on the spacing and distance (if two inverters are installed in a vertically aligned way, a baffle plate must be installed in between to keep them apart).

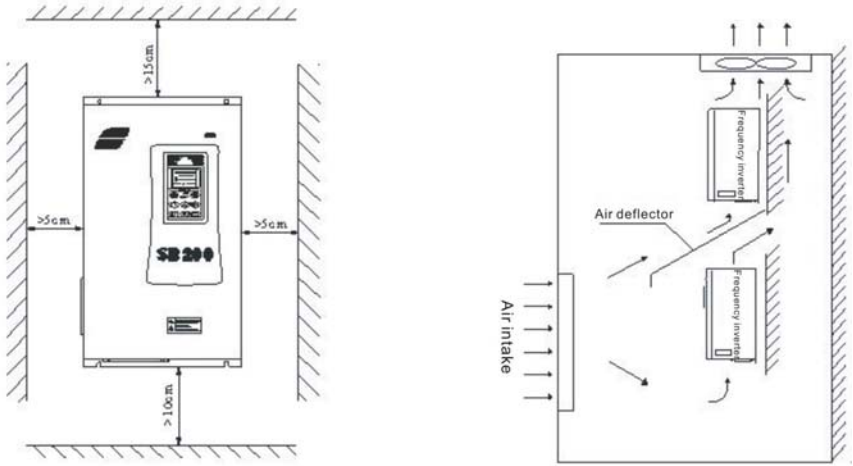

**3.2. Uninstallation/Installation of Inverter Components**

**3.2.1. Uninstallation/Installation of Cover and Control Panel**

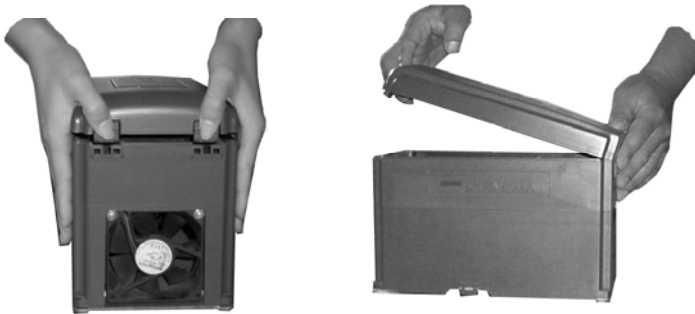

**3.2.2. Uninstallation/Installation of Control Panel**

Uninstallation: Stick a finger into the hemispheric depression above the control panel, press the elastic flap on top of the panel and pull the panel out. Refer to the following drawing.

Installation: Fit the fixing bayonet at the bottom of the panel into the dog at the bottom of the installation slot of the panel, press the upper side forward with a finger and release the finger after the panel is in place. Refer to the following drawings:

Press the spring piece and pull out

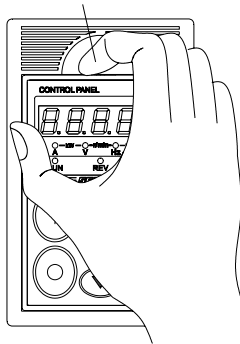

Installation of keypad

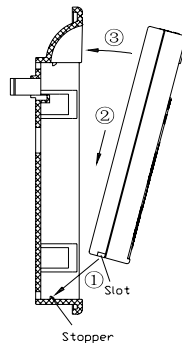

### 3.2.3. Installation of Control Panel on Cabinet Panel

The user may remove the control panel from the SB200 inverter series and install it on the cabinet panel. The control panel and the inverter may be connected by an extension cord. The user may choose from the following two installation methods:

◆ **Method 1: Direct Installation:**

- ① Drill holes and openings on the cabinet panel as per the following drawing:
- ② Remove the control panel and then the two screws on the diagonal line of the panel. Then fix the panel onto the cabinet panel with the complimentary M3×14 screws.
- ③ Insert the socket at one end of the extension cord into the control panel and fix it with the complimentary fasteners. The other end of the cord should be plugged firmly into the corresponding socket on the circuit board of the inverter. Take care to cover the inverter.

**Hole drilling for installing the control panel onto the cabinet**  
 Rectangular hole for the cord

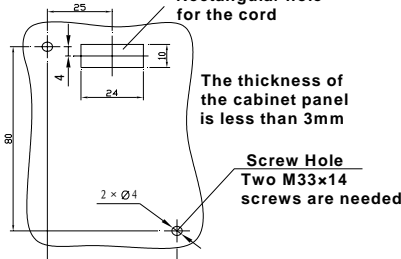

The complimentary T/SL-23 fastener is used to prevent the plug of the extension cord from coming off the control panel

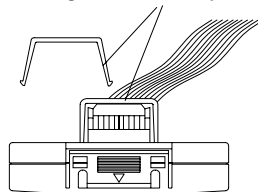

◆ **Method 2: Installation into the Mounting box:**

- ① Make an opening in the cabinet panel as per the following drawing.
- ② Install the mounting box (optional) of the control panel onto the cabinet panel.
- ③ Install the control panel into the box.

- ④ Plug the socket at one end of the extension cord into the control panel; plug the other end firmly into the corresponding socket on the circuit board of the inverter. Cover the inverter.

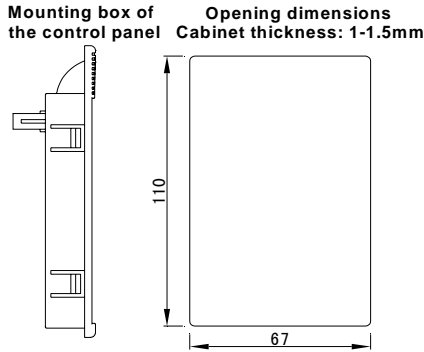

### 3.3 Wiring of Inverter

**! CAUTION**

1. Wiring operations for the inverter must be conducted by trained professionals.
2. The cover of the inverter must not be opened until five minutes after the power supply for the inverter is reliably disconnected and all indicator lamps on the control panel are extinguished
3. Internal wiring operations must not commence until the high voltage indicator lamp inside the inverter is extinguished, or the voltage between the main loop terminals (P+ and N-) measured with a voltmeter is below 36V.
4. The enclosure of the inverter must be securely earthed; otherwise there may be an electric shock or fire.
5. Terminals P+ and N- must not be connected with a jumper; otherwise there may be hazards of fire or property damage.
6. The power cord must not be connected to Terminal U, V or W.
7. The inverter must be put through a withstand voltage test prior to ex-factory delivery. It is required that no more withstand voltage tests has to be conducted; otherwise, there may be a damage to the inverter;
8. Prior to connection to the power supply, verify that the rated input voltage of the inverter conforms to the voltage rating of the AC power supply; otherwise there may be a personal injury or equipment damage.
9. The main loop terminal must be securely connected to the cold-pressed terminal of the conductor.
10. Output Terminals U, V and W must be wired in strict compliance with the phase sequence.
11. It is forbidden to connect capacitors or pressure-sensitive resistors to the output terminal of the inverter with an attempt to absorb surges.

3.3.1. Wiring and Configuration of Main Loop Terminal

Refer to the following drawing for the connection between the inverter and the peripherals:

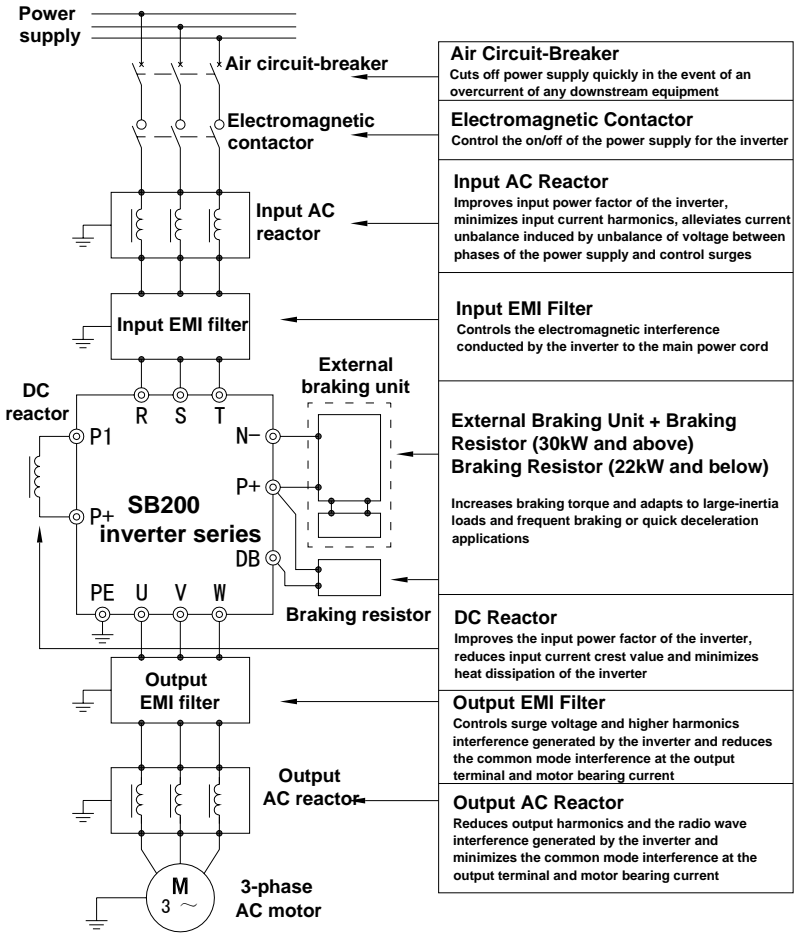

Refer to the following table for selecting the capacitance of the air circuit-breaker and the cross section of the copper-core insulated conductor:

Model No.	Air Circuit-Breaker (A)	Main Circuit Wiring (mm <sup>2</sup> )	Model No.	Air Circuit-Breaker (A)	Main Circuit Wiring (mm <sup>2</sup> )
SB200-1.5T4	16	2.5	SB200-75T4—90T4	315	60
SB200-2.2T4—4T4	20	4	SB200-110T4—132T4	400	90
SB200-5.5T4—7.5T4	40	6	SB200-160T4	500	120
SB200-11 T4—15 T4	63	8	SB200-200T4	630	180

SB200-18.5T4—22T4	100	10	SB200-220T4	630	210
SB200-30T4	125	16	SB200-250T4—280T4	850	240
SB200-37T4	160	25	SB200-315T4	1000	300
SB200-45T4—55T4	200	35	SB200-375T4—400T4	1500	400

Refer to the following drawing for fundamental wiring required for operation

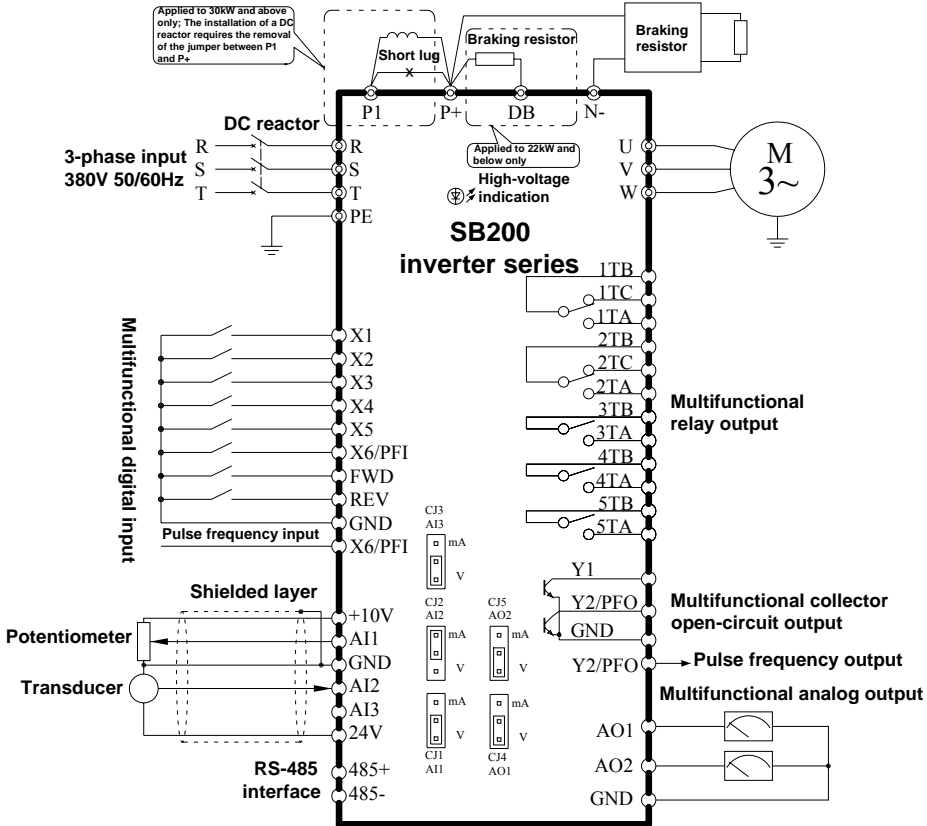

Note: Copper-core conductors of 1mm<sup>2</sup> are recommended for connecting wires of the control terminal.

Main Circuit terminal function notes:

Terminal Code	Terminal Name	Description
R/S/T	Power supply terminal	Connected to the 3-phase 380V power supply
U/V/W	Inverter output terminal	Connected to the 3-phase motor
P1/P+	DC reactor terminal	Connected to the external DC reactor (A jumper is used for connection if a reactor is inapplicable)
P+/N-	DC output terminal	Used for connection to a braking unit
DB	Braking output terminal	A braking resistor connects P+ to DB
PE	Earth terminal	The earth terminal on the inverter enclosure must be earthed

The control cable, power cable and motor cable must be kept apart in order to prevent intercoupling interference. The three types of cable must be spaced at a sufficiently wide distance, especially when they are installed parallel to each other and run for a relatively long distance. Whenever the signal cable has to cross over the power cable, they must be vertical to each other. Refer to the following drawings:

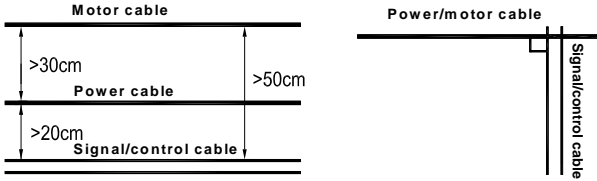

The bigger the length and the cross section of the motor cable, the bigger the capacitance to earth and the interference caused by intercoupling. Therefore, cables of a specified cross section and of an appropriately minimized length are recommended.

The following drawings specify earthing modes recommended for the wiring:

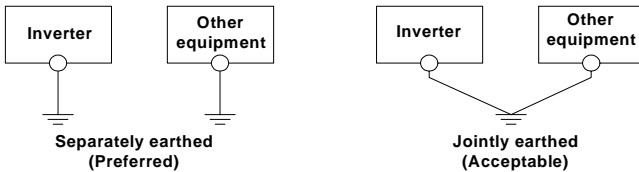

The following earthing modes are not allowed:

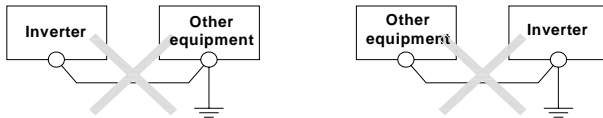

3.3.2. Terminal, Jumper and Wiring of Control Panel

Refer to the following table for the functions of jumpers on the control panel:

Code	Name	Function and Configuration	Factory Setting
CJ1	All	Input Type Options: V: Voltage mode; mA: Current mode	V

CJ2	AI2	Input Type Options: V: Voltage mode; mA: Current mode	mA
CJ3	AI3	Input Type Options: V: Voltage mode; mA: Current mode	V
CJ4	AO1	Input Type Options: V: 0-10V (voltage signal); mA: 0/4-20mA (current signal)	V
CJ5	AO2	Input Type Options: V: 0-10V (voltage signal); mA: 0/4-20mA (current signal)	V

Refer to the following tables for the layout of terminals on the control panel:

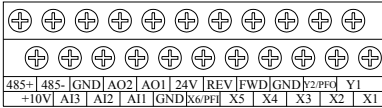

Terminals of 22kW series and below

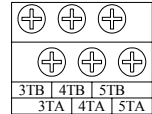
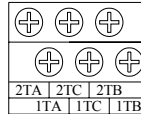
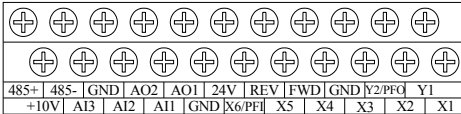

Terminals of 30kW series and above

Refer to the following table for the functions of terminals on the control panel:

Terminal Code	Terminal Name	Function and Description	Technical Specification
485+	Positive terminal of 485 differential signal	RS485 communication interface	Connectable to 1—32 RS485 stations Input impedance: >10kΩ
485—	Negative terminal of 485 differential signal		
GND	Ground (Earth)	Analog and digital input/output, PFI, PFO, communication and +10V/24V earth terminals	
+10V	Reference power supply: +10V	+10V power supply provided for the user	+10V: Max output current: 50mA Voltage accuracy: Above 2%
Y2/PFO	Pulse frequency output (when the terminal is use for PFO)	Refer to the description of Parameter F6-38 for output function options	0—50 kHz Collector open-circuit output Specification: 24V/50mA
X6/PFI	Pulse frequency input (when the terminal is applied to PFI)	Refer to the description of Parameters F6-35—F6-37	0—50 kHz; Input impedance: 1.5kΩ High level: >6V Low level: <3V Max input voltage: 30V

Terminal Code	Terminal Name	Function and Description	Technical Specification
AO1	Multifunctional Analog Output 1	Function options: Refer to the description of Parameters F6-27 and F6-31	Current mode: 0—20mA; load: ≤500Ω
AO2	Multifunctional Analog Output 2	Select the voltage/current output modes via Jumpers CJ4 and CJ5	Voltage mode: 0—10V; output: 10mA
24V	24V power supply terminal	24V power supply provided for the user	Max output current: 30mA
AI1	Analog Input 1	Function option: Refer to the description of Parameters F6-00—26  Select the voltage/current input modes via Jumpers CJ1, CJ2 and CJ3	Input voltage range: -10—+10V Input current range: -20—+20mA Input impedance: Voltage input: 110kΩ Current input: 250Ω
AI2	Analog Input 2		
AI3	Analog Input3		
X1	Digital Input Terminal X1	Refer to Menu F4 for function options and settings	Input impedance: ≥3kΩ Input voltage range: <30V Sampling period: 1ms Debouncing time: 10ms High level: > 10V Low level: <4V Equivalent to high level when disconnected from the power supply
X2	Digital Input Terminal X2		
X3	Digital Input Terminal X3		
X4	Digital Input Terminal X4		
X5	Digital Input Terminal X5		
X6/PFI	Digital Input Terminal X6 (when the terminal is used for X6)		
REV	Digital Input Terminal REV		
FWD	Digital Input Terminal FWD		
Y1	Digital Output terminal Y1	Refer to Menu F5 for function options and settings	Collector open-circuit output: Specification: 24Vdc/50mA Output action frequency: < 500Hz
Y2/PFO	Digital Output terminal Y2 (when the terminal applies to Y2)		
1TA	Output terminal of Relay 1	Refer to Menu F5 for function options and settings	TA-TB: Constantly open TB-TC: Constantly closed Contact specification: 250V AC/3A 24V DC/5A
1TB			
1TC			
2TA	Output Terminal of Relay 2		
2TB			
2TC			
3TA	Output Terminal of Relay 3		
3TB			
4TA	Output Terminal of Relay 4		
4TB			

Terminal Code	Terminal Name	Function and Description	Technical Specification
5TA 5TB	Output Terminal of Relay 5		

(1) Wiring of Analog Input Terminal

In a remote operation supported by analog signals, the control cable between the operation device and the inverter must be less than 30m. As analog signals are very vulnerable to interference, the analog control cables must be separately installed away from the strong current loop, relay loop and contactor loop. The wiring must have a sufficiently short distance and the connecting wires must be STP (shielded twisted pair) with one end connected to the GND terminal of the inverter.

(2) Wiring of Multifunctional Digital Output Terminal (Y) and Relay Output Terminals (TA, TB and TC)

If the inverter is used to drive inductive loads (e.g. electromagnetic relays, contactors and electromagnetic brakes), a surge voltage absorption circuit, pressure-sensitive resistor or freewheeling diode (used for a DC electromagnetic loop; pay attention to polarity in the course of installation) must be installed. The elements of the absorption circuit must be installed close by (at the two ends of the coil of the relay or the contactor). Refer to the following drawings:

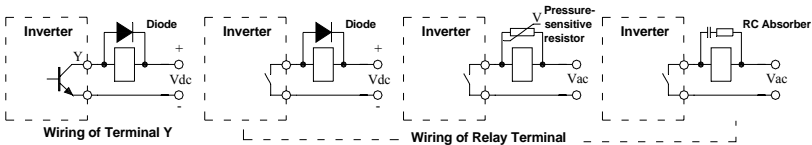

3.4. Electromagnetic Interference Control Methods

The mechanism of the inverter necessarily involves the emission of interferences which may cause electromagnetic compatibility problems to the equipment or the system (EMC). As an electronic device, the inverter is also exposed to external electromagnetic interference sources. The following paragraphs list some of the installation/design methods complying with the EMC codes. The user may refer to the information when installing or providing wiring for a inverter.

(1) Refer to the following table for electromagnetic interference control methods:

Communication Interference Sources	Solution to Interference Reduction
Leakage Current/Earthed	In cases where the peripherals form a closed loop via the wiring of the inverter, the leakage current from the earth wire of the inverter will cause a misoperation of the

Loop	equipment. If the equipment is not earthed, there will be fewer misoperations.
Power Cable Transmission	<p>In cases where the peripherals and the inverter share the same power supply, the interference generated by the inverter will be transmitted along the power cable in a reversed direction and cause misoperations of other equipment in the same system. The following steps may be taken:</p> <p>(1) Install an EMI filter or a ferrite chip common-mode filter (magnetic core) at the input end of the inverter.</p> <p>(2) Use an isolation transformer or a power supply filter to isolate the noise of other equipment.</p>
Motor Radiation Power Cord Radiation Inverter Radiation	<p>In cases where measurement instruments, radio devices, transducers and other equipment or signal lines emitting feeble signals are housed in the same cabinet as the inverter and the different wirings are closely arranged, there are more chances of misoperations as a result of interference. The following solutions are recommended:</p> <p>(1) Devices and signal lines susceptible to interference must be installed at an appropriate max distance from the inverter. The signal lines must be shielded and the shielding layer must be earthed and the signal lines must be housed in metal tubes. An appropriate max distance must be kept between the signal lines and the inverter or its lead-in/lead-out wires. In cases where a signal line has to cross over a power cable, they must be vertical to each other.</p> <p>(2) Install EMI filters or ferrite chip common-mode filter (magnetic core) on both the input side and the output side of the inverter.</p> <p>(3) The motor cable must be housed in an enclosure of relatively great thickness, e.g. tubes of relatively great thickness (above 2mm), or buried in a cement tub. The power cable must be earthed shielded cable housed in a metal tube (The motor cables must adopt 4-core cables. One cable is earthed on the inverter side and the other is connected to the motor enclosure).</p>
Electrostatic Induction Electromagnetic Induction	<p>(1) Signal lines must not run parallel to or be bound along with power cables.</p> <p>(2) Equipment or signal lines susceptible to interference must be at a max appropriate distance from the inverter and its lead-in/out wires.</p> <p>(3) Signal lines and power cables must be shielded lines housed in metal tubes. Metal tubes must be spaced at a min. of 20cm.</p>

(2) Leakage Current and Solution

The existence of earth capacitance/wire-to-wire capacitance of cables on the input/output side of the inverter and earth capacitance of the motor may induce leakage current. Leakage current includes earth leakage current and wire-to-wire leakage current, the intensity of which depends on the numerical value of distributed capacitance and carrier frequency.

Refer to the following drawing for the path of leakage current:

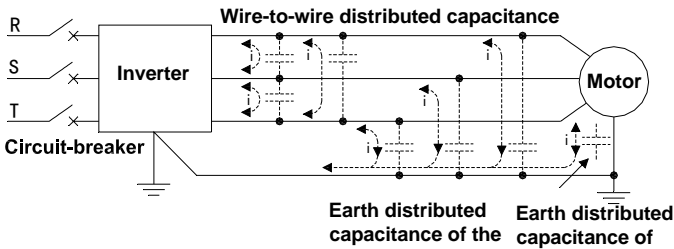

**Earth Leakage Current**

Leakage currents may leak into not only the inverter system, but also into other devices via the earth wire. These leakage currents may cause misoperations of the residual current circuit-breaker, relay or other devices. The higher the carrier frequency of the inverter is, the larger the leakage current is; the longer the motor cable is, the larger the leakage current is.

Control methods include:

- Reduction of carrier frequency (although this method may increase motor noise);
- Reduction of the motor cable length as much as possible;
- Adoption of residual current circuit-breakers specifically designed for the inverter system and other systems to minimize higher harmonics and surge leakage current.

**Wire-to-Wire Leakage Current**

Leakage currents which leak into the wire-to-wire distributed capacitance on the output side of the inverter generate higher harmonics which may cause misoperations of external thermal relays, especially a small-capacity inverter. If the wire is very long (50m or above), there will be a substantial increase of leakage currents which may cause misoperations of external thermal relays. It is recommended that a temperature transducer be used to monitor motor temperature directly, or the inverter function of motor overload protection be adopted to substitute an external thermal relay.

Control methods include:

Reduction of carrier frequency and installation of a reactor are on the output side.

## 4. Inverter Operation and Trial Operation

### 4.1. Inverter Operation and Display

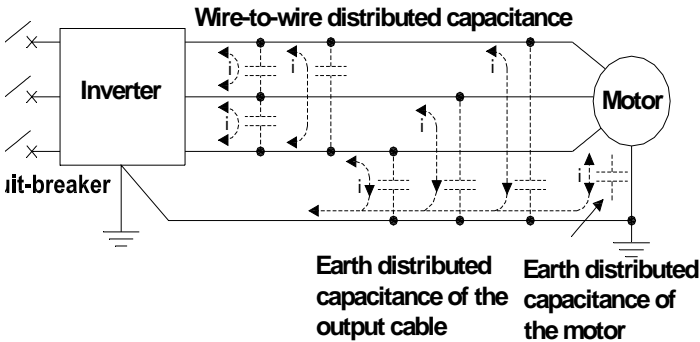

#### 4.1.1. Functions of Control Panel

The control panel is the inverter component that receives a command or displays parameters. Parameters may be set up or checked via LED control panels, such as SB-PU70 (Standard), SB-PU03 and SB-PU70E or LCD control panels (e.g. SB-PU200). Also, a control panel enables operation control, fault display and alarm emission. SB-PU70E also enables parameter copying and SB-PU200 enables real-time clock and parameter copying. Refer to the following drawings



Refer to the following table for the functions of the keys on the SB-PU70 control panel:

Icon	Name	Function
	MENU/ESC	Back to the superior menu; entry into/exit from monitoring status
	PRGM/CONF	Entry into the inferior menu; parameter storage; alarm info cancellation
	INCR	Numerical increase; press the key to attain a speed at an increased rate
	DECR	Numerical decrease; press the key to attain a speed at a decreased rate
	SHIFT	Selection of digits to be revised; monitoring parameter switching in a monitoring status
	DIR	Running direction switching; the direction key to set the hundreds-digit as 0 is null

	EXE	Execution of a command
	STOP/RESET	Shutdown and fault reset

Refer to the following units of measurement for the combinations of different indicator lamps:

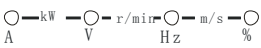
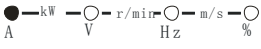
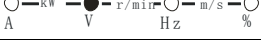
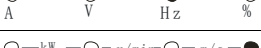
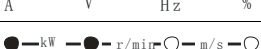
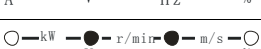
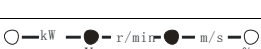
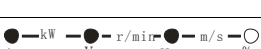
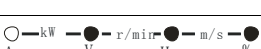
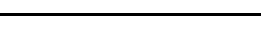
Display	Unit	Description
	Unavailable	No unit or non-displayable unit (such as °C, N, rad/s)
	A	Ampere
	V	Volt
	Hz	Hertz
	%	Percent
	kW	Kilowatt (Lamps A and V are simultaneously illuminated)
	r/min	Rotation/minute (Lamps V and Hz are simultaneously illuminated)
	m/s	Meter/second (Lamps Hz and % are simultaneously illuminated)
	Length	Meter or millimeter (Lamps A, V and Hz are simultaneously illuminated)
	Time	Hour, minute, second and millisecond (Lamps V, Hz and % are simultaneously illuminated)

Refer to the following table for the indication of the three statuses indicator lamps (RUN, REV and EXT) on the control panel:

Indicator Lamp	Display Status	Indicated Present Status of Inverter
RUN	Distinguished	Standby
	Illuminated	Stable operation
	Flashing	In acceleration or deceleration

REV	Distinguished	Both the direction settings and the present rotation direction are clockwise
	Illuminated	Both the direction settings and the present rotation direction are anticlockwise
	Flashing	The setup direction and the present running direction are not the same
EXT	Distinguished	Control status of the control panel
	Illuminated	Control status of the terminal
	Flashing	Control status of communication
Potentiometer	Illuminated	The panel potentiometer is selected via the main settings, auxiliary settings or PID settings. The settings are only effective for SB-PU03.

4.1.2. Display Status and Operation of Control Panel

The control panel of the SB200 inverter series has the following display statuses: monitoring status (including standby monitoring and operation monitoring), parameter editing status, and fault status, alarm status, etc. Refer to the following drawings for how to switch between different statuses:

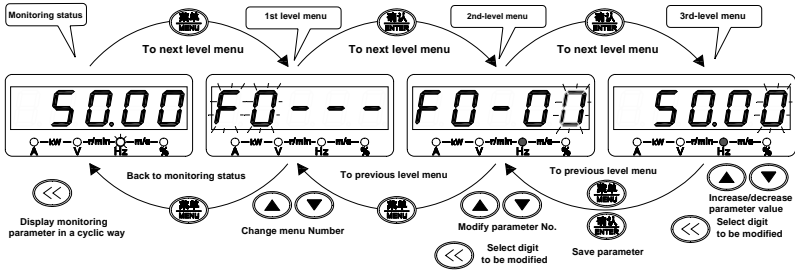

Standby Monitoring

Press under this status and the control panel will display different standby parameters (defined via FC-02—FC-08) in a cycling way.

Operation Monitoring



Press under this status and all monitoring parameters (defined via FC-02—FC-12) will be displayed in a cycling way.

Parameter Editing

Press under the monitoring status to enter the editing status. Under the editing status, the display will be in the form of a 3-hierarchy menu system (sequence: parameter group No. → Serial No. within parameter groups → parameter value). Press to enter inferior hierarchies level by level and press to return to the superior hierarchy (if it is the top hierarchy of the menu, you will return to the monitoring status). Use or to change the parameter group No., serial No., within parameter groups or parameter value. Use to shift or modify digits. Press to store modified results, return to the second hierarchy and redirect to the next parameter.

When FC-00 is set up as 1 (user parameters are displayed only) or 2 (parameters other than factory parameters are displayed only), the top hierarchy will not be displayed. This is intended to facilitate user operations.

#### Password Verification

If a user password has been set up, enter the password verification status before entry into the parameter editing status. In this case, “0.0.0.0.” will be displayed. The user may enter the password by pressing ,  and  (“———” will be displayed when the password is

being entered). After the password entry is finished, press  to cancel password protection. If

the password is incorrect, the keyboard will flash and “ERR” will be displayed. Press  to return to the verification state and press the same key again to exit from the verification state.

After password protection is cancelled, press  +  under the monitoring status, or avoid any key operation within 2 minutes, and password protection will be automatically actuated.



When FC-00 is set as 1 (only user parameters are displayed), the user parameters will not be subject to password protection. But the user password is required when changing FC-00.

#### Fault Display

The inverter will enter the fault display status upon detecting a fault signal and the indicator lamp will flash to display a fault code. The user may reset and rectify the fault by entering a reset command (press  on the control panel or operate via the control terminal or a communication command).

If the fault persists, the fault code will remain. The user may modify the incorrect parameters during this time to eliminate the fault.

#### Alarm Display

If the inverter detects an alarm signal, the nixie tube will flash to display the alarm code. If more than one type of alarm signal is emitted at one time, they will be displayed in an alternate way. Pressing  or  to disable alarm display temporarily. The inverter will automatically detect the alarm value. If the inverter returns to normal, the alarm signal will be automatically cleared. The operation of the inverter will continue in the event of an alarm.

#### Other Display Statuses

Prompt	Description
UP	Uploading parameters
DN	Downloading parameters
CP	Comparing parameters
LD	Resetting to factory settings

YES	The results of the comparison comply
-----	--------------------------------------

#### 4.2. Initial Energization

Wiring operations must be conducted as per the technical requirements of 3.3. *Wiring of Inverter* of this manual.

Check and confirm the wiring and power supply. Then close the air circuit-breaker for the AC power supply on the input side of the inverter. “8.8.8.8.” will be displayed on the control panel of the inverter. If the contactor in the inverter is normally picked up and the characters displayed by the LED nixie tube change to the set frequency, it indicates that the inverter has been successfully initialized. If any abnormality occur in the aforesaid energization steps, please open the air circuit-breaker on the output side, check the cause and rectify the fault.

#### 4.3. Guide to Quick Debugging

This part prescribes the commonest but necessary debugging steps for the SB200 inverter series on the basis of the factory settings:

1. Frequency Setting Channel and Frequency Setting: For details, refer to “F0-01: Main Setting Channel for Normal Operation” on Page 43.
2. Selection Command Execution Channel Options: For details, Refer to “F0-02: Command Execution Channel Options” on Page 43.
3. To correctly set “Max Frequency” (F0-06), “Upper Frequency Limit” (F0-07) and “Lower Frequency Limit” (F0-08), refer to Page 44 for details.
4. Direction of Motor Rotation: To confirm the phase sequence of the motor wiring and configure “Direction Lock” (F0-09) as required by the mechanical load, refer to Page 44 for details.
5. Acceleration/Deceleration Time: Set the parameter to as long as possible to meet the requirements. If the time is too short, a great torque will be generated and damage the load, or cause an overcurrent. For details, refer to *F1-00—F1-03: Acceleration/Deceleration Time* on Page 45.
6. Startup/Shutdown Mode: For details, refer to *F1-11: Startup Mode* and *F1-16: Shutdown Mode* on Page 46.

7. Parameters on Motor Nameplate: Rated power, number of poles, rated current and rated rotation speed. Refer to Page 51 for details.

8. Motor Overload Protection: For details, refer to Fb-00: Motor Heat Dissipation Conditions, Fb-01: “Motor Overload Protection Value” and Fb-02: Motor Overload Protection Action Options.

For details about optimized settings, refer to the following tips:

1. F2-00: V/F Curve Settings on Page 48.

2. F2-01: Torque Elevation Options on Page 48.

3. F2-09: “Vibration Dampening” on Page 49. This function is used to eliminate motor vibrations under a light load. If the motor vibrates, adjust the parameter from by stepping up the values until the vibration is eliminated. The parameter value must not be too great.

4. F2-02: Amplitude of Manual Torque Elevation on Page 48. If the starting current is too great, you may reduce the parameter value.

5. Auto Torque Elevation. To increase the starting torque and output torque (in low-speed operation) of the inverter, auto torque elevation is recommended (F2-01: Torque Elevation Options =2).

6. Slip Compensation on Page 49. Slip compensation can reduce a fall in speed caused by loads. This function is not enabled unless auto torque elevation is enabled. The following settings are required: F2-05: “Slip Compensation Gain”, F2-06: “Filter Time of Slip Compensation” and F2-07 and F2-08: Clipping of Slip Compensation









**5. Lists of Function Parameters**

NOTE:

Modification: “○” means that both the standby status and the operating status can be changed. “×” means that only the operating status can not be changed. “△” means “Read only”.

**F0: Basic Parameters**

Parameter	Name	Setting Range and Description	Factory Settings	Modification	Page
F0-00	Digital Frequency Settings	0.00Hz—F0-06“Max. Frequency”	50.00Hz	○	77
F0-01	Main Setting Channel for Normal Operation	0: F0-00 digital settings 1: Communication Settings 2: UP/DOWN adjustment 3: AI1 4: AI2 5: AI3 6: PFI 7: Panel potentiometer (applicable to SB-PU03 only)	0	○	77
F0-02	Command Execution Channel Options	0: Control panel 1: Terminal 2: Communication control	0	×	78

Parameter	Name	Setting Range and Description	Factory Settings	Modification	Page
F0-03	Frequency Setting Retention Mode	Units digit: Storage option on Power Failure  0: Stores the main frequency settings modified by pressing   or by communication to F0-00 upon poweroff  1: Does not store the main frequency settings modified by pressing   or by communication upon poweroff  Tens digit: Retention options on shutdown  0: Retains the main frequency settings modified by pressing   or by communication upon shutdown  1: Restores the main frequency settings modified by pressing   or by communication upon shutdown to F0-00	00	○	79
F0-04	Auxiliary Setting Channel Options	0: Unavailable 1: F0-00 2: UP/DOWN adjustment 3: AI1 4: AI2 5: AI3 6: PFI	0	○	79
F0-05	Auxiliary Channel Gain	-1.000—1.000	1.000	○	79
F0-06	Max. Frequency	F0-07—650.00Hz	50.00Hz	×	79
F0-07	Upper Frequency Limit	F0-08 “Lower Frequency Limit”—F0-06 “Max. Frequency”	50.00Hz	×	79
F0-08	Lower Frequency Limit	0.00Hz—F0-07 “Upper Frequency Limit”	0.00 Hz	×	80
F0-09	Direction Lock	0: Clockwise and anticlockwise direction 1: Clockwise direction lock 2: Anticlockwise direction lock	0	○	80
F0-10	Parameter Write Protection	0: Inapplicable 1: Applicable to all parameters but F0-00 and F7-04 2: Applicable to all parameters	0	○	80

Parameter	Name	Setting Range and Description	Factory Settings	Modification	Page
F0-11	Parameter Initialization	11: Initialization 22: Initialization applicable to all parameters but communication parameters	00	×	80
F0-12	Parameter Copying (Applicable to SB-PU70E and SB-PU200)	11: Parameters are uploaded from the inverter to the panel 22: Parameters are downloaded from the panel to the inverter 33: Verifies the unconformity of panel settings to inverter parameters 44: Clears parameters stored in the panel	00	×	81
F0-13	Rated Inverter Power	Min. unit: 0.01kW	Depend on inverter model	△	81
F0-14	Software Version No.	0.00—99.99	Depend on version	△	81
F0-15	User Password Settings	0000—9999; “0000” means no password has been set	0000	○	81

**F1: Acceleration/Deceleration, Startup, Shutdown and Jog Parameters**

Parameter	Name	Setting Range and Description	Factory settings	Modification	Page
F1-00	Acceleration Time 1	0.1—3600.0s	Depend on inverter model No.	○	82
F1-01	Deceleration Time 1	Acceleration Time: The time required for the frequency to increase by 50Hz Deceleration Time: The time required for the frequency to decrease by 50Hz NOTE: Factory settings for 22kW inverters and below are 6.0s Factory settings for 30 kW inverters and above are 20.0s			82
F1-02	Acceleration Time 2				82
F1-03	Deceleration Time 2				82
F1-04	Deceleration Time in an Emergency Shutdown	0.1—3600.0s	10.0s	○	82
F1-05	Auto Switching Point for Acceleration/Deceleration Time	0.00—650.00Hz; Below this range is Acceleration/Deceleration Time 2	0.00Hz	×	82
F1-06	Jog Frequency	0.10—50.00Hz	5.00Hz	○	84
F1-07	Jog Acceleration Time	0.1—60.0s	Depend on inverter model No.	○	84
F1-08	Jog Deceleration Time	0.1—60.0s	Depend on inverter model No.	○	84
F1-09	Clockwise/Anticlockwise Rotation Deadband Time	0.0—3,600.0s	0.0s	×	84

Parameter	Name	Setting Range and Description	Factory settings	Modification	Page
F1-10	Startup Delay Time	0.0—3,600.0s Inapplicable when F8-00 is not "0"	0.0s	○	85
F1-11	Startup Mode	0: Startup at the startup frequency 1: DC braking comes before startup at the startup frequency 2: Startup in the rotation speed tracking mode	0	×	85
F1-12	Startup Frequency	0.00—60.00Hz	0.50Hz	○	85
F1-13	Startup Frequency Maintenance Time	0.0—60.0s	0.0s	○	85
F1-14	Startup DC Braking Time	0.0—60.0s	0.0s	○	85
F1-15	Startup DC Braking Current	0.0—100.0%; the rated current of the inverter is taken as 100%	0.0%	○	85
F1-16	Shutdown Mode	0: Shutdown in deceleration mode 1: Free shutdown 2: Deceleration+ DC braking	0	○	86
F1-17	Shutdown/DC Braking Frequency	0.00—60.00Hz	0.50Hz	○	86
F1-18	Shutdown DC Braking Latency Time	0.00—10.00s	0.00s	○	86
F1-19	Shutdown DC Braking Time	0.0—60.0s	0.0s	○	87
F1-20	Shutdown DC Braking Current	0.0—100.0%; the rated inverter current is taken as 100%	0.0%	○	87

**F2: V/F Control Parameters**

Parameter	Name	Setting Range and Description	Factory settings	Modification	Page
F2-00	V/F Curve Settings	0: Custom 1: Linear 2: V/F Curve 1 (Torque lowering) 3: V/F Curve 2 (Torque lowering) 4: V/F Curve 3 (Torque lowering) 5: V/F Curve 4 (Torque lowering) 6: V/F Curve 5 (Torque lowering)	1	×	88
F2-01	Torque Elevation Options	0: Inapplicable 1: Manual elevation 2: Auto elevation 3: Manual elevation + auto elevation	1	×	88
F2-02	Amplitude of Manual Torque Elevation	0.0%—the max. value depends on inverter model number; min. unit: 0.1%	Depend on inverter model No.	○	89
F2-03	Cut-Off Point of Manual Torque Elevation	0.0—100.0%; F2-12 is taken as 100%	10.0%	○	89
F2-04	Auto Torque Elevation Range	0.0—100.0%	100.0%	×	89
F2-05	Slip Compensation Gain	0.0—300.0%	0.0%	○	90
F2-06	Filter Time of Slip Compensation	0.1—25.0s	1.0s	×	90
F2-07	Clipping of Electric Slip Compensation	0—250%; The rated slip frequency of the motor is taken as 100%	200%	×	90
F2-08	Clipping of Regenerated Slip Compensation	0—250%; The rated slip frequency of the motor is taken as 100%	200%	×	90
F2-09	Vibration Dampening	0—200	Depend on inverter model No.	○	91
F2-10	AVR Settings	0: Inapplicable 1: Always applicable 2: Only inapplicable in deceleration	1	×	91
F2-11	Auto Energy-Saving Options	0: Inapplicable 1: Applicable	0	○	92
F2-12	Basic Frequency	1.00—650.00Hz	50.00Hz	×	92
F2-13	Max. Output Voltage	150—500V	380V	×	92
F2-14	V/F Frequency F4	F2-16—F2-12	0.00Hz	×	92
F2-15	V/F Voltage V4	F2-17—100.0%; F2-13 is taken as 100%	0.0%	×	92
F2-16	V/F Frequency F3	F2-18—F2-14	0.00Hz	×	93
F2-17	V/F Voltage V3	F2-19—F2-15; F2-13 is taken as 100%	0.0%	×	93
F2-18	V/F Frequency F2	F2-20—F2-16	0.00Hz	×	93
F2-19	V/F Voltage V2	F2-21—~F2-17; F2-13 is taken as 100%	0.0%	×	93
F2-20	V/F Frequency F1	0.00Hz—F2-18	0.00Hz	×	93

Parameter	Name	Setting Range and Description	Factory settings	Modification	Page
F2-21	V/F Voltage V1	0.0%—F2-19; F2-13 is taken as 100%	0.0%	×	93

### F3. Motor Parameters

Parameter	Name	Setting Range and Description	Factory settings	Modification	Page
F3-00	Rated Power	0.40—500.00kW	Depend on inverter model No.	×	94
F3-01	Number of Poles	2—48	4	×	94
F3-02	Rated Current	0.5—1200.0A	Depend on inverter model No.	×	94
F3-03	Rated Frequency	1.00—650.00Hz	50.00Hz	×	94
F3-04	Rated Rotation Speed	125—40000r/min	Depend on inverter model No.	×	94

### F4: Digital Input Terminals and Multi-Speed

Parameter	Name	Setting Range and Description	Factory settings	Modification	Page
F4-00	Functions of Digital Input Terminal X1	0: Connection to the following signals is inapplicable ±1: Multi-band frequency option 1 ±2: Multi-band frequency option 2 ±3: Multi-band frequency option 3 ±4: Check of upper water level limit of clean water pool ±5: Check of lower water level limit of clean water pool ±6: Check of water shortage level of clean ±31: Check of Contactor 5K2 ±32: Auxiliary setting channel disabled ±33: Switching of PID settings to AI2 ±34: Shutdown DC-braking ±35: PID (Process identification) disabled ±36: PID Parameter 2 Option ±37: Three-wire mode shutdown command ±38: Internal virtual FWD terminal ±39: Internal virtual REV terminal ±40: Retention of	1	×	95
F4-01	Functions of Digital Input Terminal X2		2		
F4-02	Functions of Digital Input Terminal X3		3		
F4-03	Functions of Digital Input Terminal X4		12		
F4-04	Functions of Digital Input Terminal X5		13		
F4-05	Functions of Digital Input Terminal X6/PFI/Pulse Frequency Input		0		
F4-06	Functions of Digital Input Terminal X7 (Extension Terminal)		0		

Parameter	Name	Setting Range and Description	Factory settings	Modification	Page
F4-07	Functions of Digital Input Terminal X8 (Extension Terminal)	water pool ±7: Acceleration/deceleration time option 2 ±8: Multi-PID Option 1	analog frequency settings ±41: Acceleration/deceleration disabled ±42: Switching of command execution channel to terminal or panel	0	
F4-08	Functions of Digital Input Terminal X9 (Extension Terminal)	±9: Multi-PID Option 2 ±10: Multi-PID Option 3	±43: Pump #1 disabled/Motor Option 1 ±44: Pump #2 disabled/Motor Option 2	0	
F4-09	Functions of Digital Input Terminal X10 (Extension Terminal)	±11: Switching of frequency settings to All ±12: External fault input	±45: Pump #3 disabled ±46: Pump#4 disabled ±47: Pump #5 disabled	0	
F4-10	Functions of Digital Input Terminal X11 (Extension Terminal)	±13: Fault reset ±14: Clockwise jog ±15: Anticlockwise jog	±48: Small sleeping pump disabled ±49: Drainage pump disabled	0	
F4-11	Functions of FWD Terminal	±16: Emergency shutdown ±17: Inverter operation disabled	±50: Lower water level limit of Wastewater Pool ±51: Upper water level limit of Wastewater Pool	38	
F4-12	Functions of REV Terminal	±18: Free shutdown ±19: UP/DOWN: UP ±20: UP/DOWN: DOWN ±21: UP/DOWN CLEAR ±22: Check of Contactor 1K1 ±23: Check of Contactor 1K2 ±24: Check of Contactor 2K1 ±25: Check of Contactor 2K2 ±26: Check of Contactor 3K1 ±27: Check of Contactor 3K2 ±28: Check of Contactor 4K1 ±29: Check of Contactor 4K2 ±30: Check of Contactor 5K1  NOTE: A negative value indicates an effective high level	±52: Signal of upper water level limit ±53: Signal of lower water level limit ±54: Signal of firefighting system in operation ±55: Priority pump startup option 1 ±56: Priority pump startup option 2 ±57: Priority pump startup option 3	39	

Parameter	Name	Setting Range and Description	Factory settings	Modification	Page
F4-13	Terminal Working Mode	0: Single-wire mode (startup/shutdown) 1: Two-Wire Mode 1 (anticlockwise) 2: Two-Wire Mode 2 (startup/shutdown and direction) 3: Two-Wire Mode 3 (startup/shutdown) 4: Three-Wire Mode 1 (clockwise/anticlockwise and shutdown) 5: Three-Wire Mode 2 (operation, direction and shutdown)	1	×	102
F4-14	Debouncing Time of Digital Input Terminal	0—2,000ms	10ms	○	104
F4-15	UP/DOWN Adjustment	0: Terminal level mode 1: Terminal pulse mode 2: Control panel level mode 3: Control panel pulse mode	0	○	104
F4-16	UP/DOWN Rate/Step Length	0.01—100.00; unit: %/s or %	1.00	○	104
F4-17	UP/DOWN Memory Options	0: Storage on poweroff 1: Reset on poweroff 2: Reset on shutdown or poweoff	0	○	104
F4-18	UP/DOWN Upper Limit	0.0—100.0%	100.0%	○	104
F4-19	UP/DOWN Lower Limit	-100.0—0.0%	0.0%	○	104
F4-20—F4-26	Multi-Band Frequency (1—7)	0.00—650.00Hz The factory settings of Multi-Band Frequency 1 through to Multi-Band Frequency 7 are their respective Multi-Band Frequency Numbers. Example: The factory setting of Multi-Band Frequency 3 is 3.00Hz	n.00Hz (n=1—7)	○	105

Frequency Bands and Corresponding Parameters

n	1	2	3	4	5	6	7
Frequency Band n	F4-20	F4-21	F4-22	F4-23	F4-24	F4-25	F4-26

**F5: Settings of Digital Output and Relay Output**

Parameter	Name	Setting Range and Description	Factory settings	Modification	Page
F5-00	Functions of Digital Output Terminal Y1	0: Inverter ready for operation  ±31: Motor #4 in line-frequency operation	1	×	105

Parameter	Name	Setting Range and Description		Factor setting s	Mod ification	Page
F5-01	Functions of Digital Output Terminal Y2/PFO/Pulse Frequency Output	±1: Inverter in operation ±2: Frequency attained ±3: Output of Monitor 1 ±4: Output of Monitor 2 ±5: Output of Monitor 3	±32: Motor #5 in variable-frequency operation ±33: Motor #5 in line-frequency operation	2		105
F5-02	Output Functions of Relay T1	±6: Fault output ±7: Motor overload	±34: X1 ±35: X2	6		106
F5-03	Output Functions of Relay T2	±8: Motor overload ±9: Undervoltage lockout	±36: X3 ±37: X4	24		106
F5-04	Output Functions of Relay T3	±10: Shutdown by external fault	±38: X5 ±39: X6	25		106
F5-05	Output Functions of Relay T4	±11: Fault self-reset in process	±40: X7 (Extension terminal)	26		106
F5-06	Output Functions of Relay T5	±12: Instantaneous poweroff/poweron in process	±41: X8 (Extension terminal) ±42: X9 (Extension terminal)	27		106
F5-07	Output Functions of T6/Y3 (extension output)	±13: Alarm output ±14: Anticlockwise operation in process ±15: Shutdown in process	±43: X10 (Extension terminal) ±44: X11(Extension terminal)	28		106
F5-08	Output Functions of T7/Y4 (extension output)	±16: Operation disabled ±17: Under control of control panel	±45: FWD ±46: REV	29		106
F5-09	Output Functions of T8/Y5 (extension output)	±18: Output at a preset time ±19: Upper frequency limit enabled ±20: Lower frequency limit enabled	±47: Pump ready for acceleration ±48: Pump ready for deceleration	30		106
F5-10	Output Functions of T9/Y6 (Extension output)	±21: Power generation in process	±49: Startup signal of auxiliary starter ±50: Operating terminal of sleeping pump	31		106

Parameter	Name	Setting Range and Description		Factor setting s	Mod ification	Page
F5-11	Output Functions of T10/Y7 (Extension Output)	±22: PC digital quantity 1 ±23: PC digital quantity 2 ±24: Motor #1 in variable-frequency operation ±25: Motor #1 in line frequency operation ±26: Motor #2 in variable frequency operation ±27: Motor #2 in line-frequency operation ±28: Motor #3 in variable frequency operation ±29: Motor #3 in line-frequency operation ±30: Motor #4 in variable frequency operation	±51: Indication for sleeping operation ±52: Water shortage in suction pool ±53: Abnormal closing of contactor ±54: drainage pump control ±55: Water injection valve control for Pump #1 ±56: Air vent valve control for Pump #1 ±57: Water injection valve control for Pump #2 ±58: Air vent valve control for Pump #2 ±59: Firefighting patrol in operation ±60: AI1>AI3	32		106
F5-12	Output Functions of T11/Y8 (Extension output)	NOTE: A negative value indicates that the relay will be switched off when an effective signal is emitted		33		106
F5-13	Attainment of Frequency to Detection Width	0.00—650.00Hz		2.50Hz	○	110
F5-14	Monitors 1, 2 and 3 Options	Hundreds digit: Monitor 3 Tens digit: Monitor 2 Units digit: Monitor 1	0: Working frequency; Detection Mode 1 1: Working frequency; Detection Mode 2 2: PID feedback value; Detection Mode 1 3: PID feedback value; Detection Mode 2	000	○	111
F5-15	Detected Value of Monitor 1	Frequency detection: The input parameter is the value of the detected frequency PID feedback value detection: The input parameter is the value of the detected feedback value		20.00	○	111
F5-16	Detection Lag Value of Monitor 1			5.00	○	111
F5-17	Detected Value of Monitor 2			40.00	○	111

Parameter	Name	Setting Range and Description	Factory settings	Modification	Page
F5-18	Detection Lag Value of Monitor 2		5.00	○	111
F5-19	Detected Value of Monitor 3		60.00	○	111
F5-20	Detection Lag Value of Monitor 3		5.00	○	111

Parameter	Name	Setting Range and Description	Factory settings	Modification	Page
F5-21	Terminal Y1 Closing Delay	0.00—650.00s	0.00s	○	
F5-22	Terminal Y1 Opening Delay		0.00s		
F5-23	Terminal Y2 Closing Delay		0.00s		
F5-24	Terminal Y2 Opening Delay		0.00s		
F5-25	Terminal T1 Closing Delay	0.00—650.00s	0.00s	○	112
F5-26	Terminal T1 Opening Delay		0.00s		
F5-27	Terminal T2 Closing Delay		0.00s		
F5-28	Terminal T2 Opening Delay		0.00s		
F5-29	Terminal T3 Closing Delay		0.00s		
F5-30	Terminal T3 Opening Delay		0.00s		
F5-31	Terminal T4 Closing Delay		0.00s		
F5-32	Terminal T4 Opening Delay		0.00s		
F5-33	Terminal T5 Closing Delay		0.00s		
F5-34	Terminal T5 Opening Delay		0.00s		

**F6: Terminals Settings for Analog Quantities and Pulse Frequency**

Parameter	Name	Setting Range and Description	Factory settings	Modification	Page
F6-00	A11 Min. Input Analog Quantity	-100.00—100.00%	0.00%	○	113
F6-01	A11 Max. Input Analog Quantity		100.00%	○	113
F6-02	Set Value/Feedback Value Corresponding with A11 Min. Input Analog Quantity	-100.00—100.00%	0.00%	○	114
F6-03	Set Value/Feedback Value Corresponding with A11 Max. Input Analog Quantity	NOTE: Frequency settings must be based on the max. frequency as a reference; the PID set value/feedback value must be represented as the percentage of the PID reference values	100.00%	○	114
F6-04	Input Analog Quantity of A11 Inflection Point	F6-00 “Min. Analog Quantity”—F6-01“Max. Analog Quantity”	0.00%	○	114
F6-05	Deviation from A11 Inflection Point	0.00—50.00%	2.00%	○	114
F6-06	Set Value/Feedback Value Corresponding with A11 Inflection Point	-100.00—100.00%	0.00%	○	114
F6-07	A11 Offline Threshold	-20.00—20.00%	0.00	○	114
F6-08	A11 Input Filter Time	0.000—10.000s	0.100s	○	114
F6-09	A12 Min. Input Analog Quantity	-100.00—100.00%	20.00%	○	114
F6-10	A12 Max. Input Analog Quantity		100.0%	○	114
F6-11	Set Value/Feedback Value Corresponding with A12 Min. Input Analog Quantity	-100.00—100.00%	0.00%	○	115
F6-12	Set Value/Feedback Value Corresponding with A12 Max. Input Analog Quantity	NOTE: Frequency settings must be based on the max. frequency as a reference; the PID set value/feedback value must be represented as the percentage of the PID reference values	100.00%	○	115
F6-13	Input Analog Quantity of A12 Inflection Point	F6-09 “min. analog quantity”—F6-10“maxium analog quantity”	20.00%	○	115
F6-14	Deviation from A12 Inflection Point	0.00—50.00%	2.00%	○	115
F6-15	Set Value/Feedback Value Corresponding with A12 Inflection Point	-100.00—100.00%	0.00%	○	115
F6-16	A12 Offline Threshold	-20.00—20.00%	0.00	○	115
F6-17	A12 Input Filter Time	0.000—10.000s	0.100s	○	115
F6-18	A13 Min. Input Analog Quantity	-100.00—100.00%	0.00%	○	115
F6-19	A13 Max. Input Analog Quantity		100.0%	○	115

Parameter	Name	Setting Range and Description	Factory settings	Modification	Page
F6-20	Set Value/Feedback Value of AI3 Min. Input Analog Quantity	-100.00—100.00% NOTE: Frequency settings must be based on the max. frequency as a reference; the PID set value/feedback value must be represented as the percentage of the PID reference values	0.00%	○	116
F6-21	Set Value/Feedback Value of AI3 Max. Input Analog Quantity		100.00%	○	116
F6-22	Input Analog Quantity of AI3 Inflection Point	F6-18“min. analog quantity”— F6-19“max. analog quantity”	0.00%	○	116
F6-23	Deviation from AI3 Inflection Point	0.00—50.00%	2.00%	○	116
F6-24	Set Value/Feedback Value Corresponding with AI3 Inflection Point	-100.00—100.00%	0.00%	○	116
F6-25	AI3 Offline Threshold	-20.00—20.00%	0.00%	○	116
F6-26	AI3 Input Filter Time	0.000—10.000s	0.100s	○	116
F6-27	AO1 Function Options	0: Working frequency 1: Set frequency 2: Output current 3: Output voltage 4: Output power 5: PID feedback value 6: PID set value 7:PID output value 8: AI1 9: AI2 10: AI3 11:PFI 12: UP/DOWN adjustment 13: DC busbar voltage 14: Take the offset value as output value (the value must not be negative)	0	○	120
F6-28	AO1 Type Options	0: 0—10V or 0—20mA 1: 2—10V or 4—20mA 2: 5V or 10mA is taken as the center	0	○	120
F6-29	AO1 Gain	0.0—1000.0%	100.0%	○	120
F6-30	AO1 Offset	-100.00—100.00%; take 10V or 20mA as 100%	0.00%	○	120
F6-31	AO2 Function Options	Same as AO1 function options: F6-27	2	○	120
F6-32	AO2 Type Options	Same as AO1 type options: F6-28	0	○	120
F6-33	AO2 Gain	0.0—1,000.0%	100.0%	○	120
F6-34	AO2 Offset	-100.00—100.00%; take 10V or 20mA as 100%	0.00%	○	120
F6-35	PFI Frequency Corresponding with 100%	0—50,000Hz	10000Hz	○	122

Parameter	Name	Setting Range and Description	Factory settings	Modification	Page
F6-36	PFI Frequency Corresponding with 0%	0—50,000Hz	0Hz	○	122
F6-37	PFI Filter Time	0.000—10.000s	0.100s	○	122
F6-38	Y2/PFO Function Options	0—13; same as AO1 function option F6-27 14: Digital output	14	○	122
F6-39	PFO Output Pulse Modulation Mode	0: Frequency modulation      1: Duty ratio modulation	0	○	122
F6-40	PFO Frequency Corresponding with 100%	0—50,000Hz; also used as the frequency of duty ratio modulation	10000Hz	○	122
F6-41	PFO Frequency Corresponding with 0%	0—50,000Hz	0Hz	○	123
F6-42	PFO Duty Ratio Corresponding with 100%	0.0—100.0%	100.0%	○	123
F6-43	PFO Duty Ratio Corresponding with 0%	0.0—100.0%	0.0%	○	123

**F7: PID Parameters**

Parameter	Name	Setting Range and Description	Factory settings	Modification	Page
F7-00	PID Control Function Options	0: PID control is not selected 1: PID control is selected 2: PID is selected for frequency settings modification 3: PID control is selected for constant pressure water supply	0	×	123
F7-01	Channel Setting Options	0: F7-04 1: AI1 2: AI2 3: AI3 4: UP/DOWN adjustment 5: PFI 6: Communication settings 7: AI1-AI2 8: AI1+AI2 9: Panel potentiometer (available only for SB-PU03)	0	×	125
F7-02	Feedback Channel Options	0: AI1 1: AI2 2: AI3 3: AI1-AI2 4: AI1 + AI2 5: $\sqrt{ AI1 }$ 6: $\sqrt{ AI2 }$ 7: $\sqrt{ AI1-AI2 }$ 8: $\sqrt{ AI1 }+\sqrt{ AI2 }$ 9: PFI 10: MAX(AI1, AI3) 11: MIN(AI1, AI3)	0	×	125
F7-03	PID Reference Scalar	0.00—100.00 (Transducer measurement range)	10.00	○	125
F7-04	PID Digital Setting	-F7-03—F7-03	5.00	○	125
F7-05	Proportional Gain 1	0.00—100.00	0.20	○	126
F7-06	Integration Time 1	0.01—100.00s	20.00s	○	126
F7-07	Derivation Time 1	0.00—10.00s	0.00s	○	126
F7-08	Proportional Gain 2	0.00—100.00	0.20	○	126
F7-09	Integration Time 2	0.01—100.00s	20.00s	○	126
F7-10	Derivation Time 2	0.00—10.00s	0.00s	○	126
F7-11	PID Parameter Transition Mode	0: Input 36 for “PID Parameter 2 Options“ in a digital mode and confirm 1: Transition according to the Working frequency 2: Transition according to the deviation	0	×	126

Parameter	Name	Setting Range and Description	Factory settings	Modification	Page
F7-12	Sampling Period	0.001—10.000s	0.010s	○	127
F7-13	Ultimate Deviation	0.0—20.0%; PID settings is taken as 100%	0.0%	○	127
F7-14	Set Value Increase/Decrease Time	0.00—20.00s	0.00s	○	128
F7-15	PID Adjustment Characteristics	0: Positive action 1: Negative action	0	×	128
F7-16	Integral Control Options	0: No integral action 1: Integral action	1	×	110
F7-17	PID Upper Amplitude Limit	F7-18“PID Lower Amplitude Limit”—100.0%	100.0%	○	129
F7-18	PID Lower Amplitude Limit	-100.0%—F7-17“PID Upper Amplitude Limit”	0.0%	○	129
F7-19	PID Differential Amplitude Clipping	0.0—100.0%; clipping of the upper/lower amplitude limits of differential components	5.0%	○	129
F7-20	PID Preset Value	-F7-18—F7-17	0.0%	○	129
F7-21	PID Preset Value Hold Time	0.0—3,600.0s	0.0s	×	129
F7-22	Multi-PID Setting 1	-F7-03—F7-03	1.00	○	130
F7-23	Multi-PID Setting 2		2.00		
F7-24	Multi-PID Setting 3		3.00		
F7-25	Multi-PID Setting 4		4.00		
F7-26	Multi-PID Setting 5		5.00		
F7-27	Multi-PID Setting 6		6.00		
F7-28	Multi-PID Setting 7		7.00		

### F8: Dedicated Water Supply Functions

Parameter	Name	Setting Range and Description	Factory settings	Modification	Page
F8-00	Water Supply Function Modes	0: Water supply function is not selected 1: Common PI-regulated constant-pressure water supply 2: Water level control 3: Pumps are started on by one in the sequence based on water pump capacity 4: Firefighting water supply	0	×	130

Parameter	Name	Setting Range and Description	Factory settings	Modification	Page
F8-01	Pump Settings and Sleeping Options	Units digit: Number of variable frequency cyclical switchover pumps: 1~5 Tens digit: Number of auxiliary pumps : 0~4 Hundreds digit: Startup mode of auxiliary pump 0: Direct startup 1: Started by soft starter Thousands digit: Sleeping and sleeping pump options 0: Sleeping operation is not selected 1: The sleeping pump works at a variable frequency 2: The sleeping pump works at a line frequency 3: The main pump is working in sleeping mode Ten thousands digit: Drainage pump options 0: Drainage pump not under control 1: Drainage pump under control	00001	×	131
F8-02	Fault and PID Lower Limit Options	Units digit: PID lower limit options 0: Operation stopped 1: Operation maintained Tens digit: Fault action options 0: All pumps are shut down and in fault status 1: The pump in line frequency operation resumes operation after a fault reset 2: The pump in line frequency operation are on standby after a fault reset	00	×	113
F8-03	Clean Water Pool/Waste Water Pool Level Signal Options	Tens digit: Waste water pool signal options Units digit: Clean water pool signal options: 0: Water level signal is not subject to detection 1: Analog signal AI1 input 2: Analog signal AI2 input 3: Analog signal AI3 input 4: Digital signal input	00	○	133
F8-04	Clean Water Pool Lower Level Limit Signal	0.0~100.0%	30.0%	○	133
F8-05	Clean Water Pool Upper Level Limit Signal		80.0%	○	133
F8-06	Clean Water Pool Water Shortage Signal		50.0%	○	133
F8-07	Pressure Settings for Clean Water Pool at the Time of Water Shortage	-F7-03~F7-03	4.00	○	133

Parameter	Name	Setting Range and Description	Factory settings	Modification	Page
F8-08	Waste Water Pool Lower Level Limit Signal	0.0~100.0%	30.0%	○	133
F8-09	Waste Water Pool Upper Level Limit Signal		80.0%	○	133
F8-10	Increasing Pump Coming Frequency	0.0~600.0s	30.0s	○	135
F8-11	Increasing Pump Coming Frequency		30.0s	○	135
F8-12	Decreasing Pump Deviation Upper Limit Settings	0.00~50.00Hz	40.00 Hz	○	136
F8-13	Increasing Pump Deviation Lower Limit Settings		45.00 Hz	○	136
F8-14	Increasing Pump Coming Frequency	-F7-03~F7-03	0.20	○	136
F8-15	Increasing Pump Coming Frequency		-0.20	○	136
F8-16	Mechanical Interlock Time	0.05~20.00s	0.50s	○	136
F8-17	Auxiliary Starter Startup Time	0.50~60.00s	5.00s	○	137
F8-18	Periodic Rotation Time	0.0~1000.0h (0.0 is ineffective)	360.0h	○	137
F8-19	Lower Frequency Limit Operation Shutdown Time	0.0~1200.0s (0.0 is ineffective)	300.0s	○	137
F8-20	Sleeping Frequency	1.00~50.00Hz	40.00 Hz	○	137
F8-21	Sleeping Latency Time	1.0~1800.0s	60.0s	○	138
F8-22	Wakeup Deviation Settings	-F7-03~F7-03	-0.20	○	138
F8-23	Wakeup Time Delay	0.1~300.0s	30.0s	○	138
F8-24~28	Min. Working frequency of Water Pumps #1~#5	1.00~F0-07“ Upper Frequency Limit”	20.00 Hz	○	139
F8-29	Min. Working frequency of Small Sleeping Pump		20.00 Hz	○	139
F8-30~34	Rated Current of Pumps #1~#5	0.5~1200.0A	Depend on inverter	×	139

Parameter	Name	Setting Range and Description	Factory settings	Modification	Page
F8-35	Rated Current of Small Sleeping Pump		model No.	×	140
F8-36	Trial Working frequency	1.00~F0-07“Upper Frequency Limit”	25.00 Hz	○	140
F8-37	Pump Trial Operation	111 Sleeping pump in trial operation 222 Drainage pump in trial operation 331~335 Pumps #1~#5 in trial operation at a variable frequency 441~445 Pumps #1~#5 in trial operation at a line frequency	000	×	140
F8-38	Pump Trial Operation Timekeeping	0.5~3000.0s	20.0s	○	140
F8-39	Pump Startup/Shutdown Sequence	Units digit: Shutdown sequence (applicable only to auxiliary pumps) 0: First to be started and first to be shut down 1: First to be started and last to be shut down Tens digit: Startup sequence (0~5 Cyclical Switchover Pump Options) 0: The pump to be first started is selected via the control terminal 1: Pump #1 is the first to start 2: Pump #2 is the first to start 3: Pump #3 is the first to start 4: Pump #4 is the first to start 5: Pump #5 is the first to start 6: Start pumps that have been shut down for a long time	10	×	141
F8-40	Firefighting Patrol Interval	0.1~720.0h	360.0h	○	141
F8-41	Firefighting Patrol Duration	10.0s~1,800.0s	900.0s	○	141
F8-42	Water Injection Valve/Air Vent Valve Control	Tens digit: Pump #2 Units digit: Pump #1 0: Water injection valve/air vent valve inapplicable 1: Control for water injection valve	00	○	142
F8-43	Water Injection/Air Vent Duration	10.0~360.0s	180.0s	○	142
F8-44~48	Pumps #1~#5 Disabled	0: Ineffective 11: Pump operation disabled	0	○	142
F8-49	Small Sleeping Pump Disabled		0	○	142
F8-50	Drainage Valve Disabled		0	○	142

Parameter	Name	Setting Range and Description	Factory settings	Modification	Page
F8-51	Standby Pump Number Settings	00~22 Units digit: Number of cyclical switchover pumps on standby Tens digit: Number of auxiliary pumps on standby	00	○	143

**F9: Time Management (Applicable to LCD Control Panel Only)**

Parameter	Name	Setting Range and Description	Factory settings	Modification	Page
F9-00	Time Settings at Point T1	Hour: 0~23; minute: 0~59 (T1 ≤ T2 ≤ T3 ≤ T4 ≤ T5 ≤ T6 ≤ T7 ≤ T8)	0.00	○	143
F9-01	Time Settings at Point T2		3.00	○	143
F9-02	Time Settings at Point T3		6.00	○	143
F9-03	Time Settings at Point T4		9.00	○	143
F9-04	Time Settings at Point T5		12.00	○	143
F9-05	Time Settings at Point T6		15.00	○	143
F9-06	Time Settings at Point T7		18.00	○	143
F9-07	Time Settings at Point T8		21.00	○	143
F9-08	Action Options at Point T1	0: No action ±1: Control for Y1 Digital Output ±2: Control for Y2 Digital Output ±3: Control for T1 Relay Output ±4: Control for T2 Relay Output ±5: Control for T3 Relay Output ±6: Control for T4 Relay Output ±7: Control for T5 Relay Output ±8: Virtual Digital Input 1 ±9: Virtual Digital Input 2 ±10: Virtual Digital Input 3 ±11: Virtual Digital Input 4	0	×	143
F9-09	Action Options at Point of Time T2		0	×	143
F9-10	Action Options at Point T3		0	×	143
F9-11	Action Options at Point T4		0	×	144
F9-12	Action Options at Point T5		0	×	144
F9-13	Action Options at Point T6		0	×	144
F9-14	Action Options at Point T7		0	×	144
F9-15	Action Options at Point T8		0	×	144
F9-16	Functions of Virtual Digital Input 1	0~54 have the same definitions as Input Terminal X	0	×	144
F9-17	Functions of Virtual Digital Input 2		0	×	144
F9-18	Functions of Virtual Digital Input 3		0	×	144

Parameter	Name	Setting Range and Description	Factory settings	Modification	Page
F9-19	Functions of Virtual Digital Input 4		0	×	144

**Fb: Protection Functions and Advanced Inverter Settings**

Parameter	Name	Setting Range and Description	Factory settings	Modification	Page
Fb-00	Motor Heat Dissipation Conditions	0: Conventional motor 1: Variable frequency motor or complete with a separate fan	0	○	145
Fb-01	Motor Overload Protection Value	50.0~150.0%; the rated motor current is taken as 100%	100.0%	○	145
Fb-02	Motor Overload Protection Action Options	0: No action 1: Alarm 2: Fault and free shutdown	2	×	145
Fb-03	Motor Overload Protection Options	Units digit: Overload detection options 0: Always on 1: During only constant-speed operation Tens digit: Overload action options 0: No action 1: Alarm 2: Fault and free shutdown	00	×	146
Fb-04	Motor Overload Detection Level	20.0~200.0%: the rated motor current is taken as 100%	130.0%	×	146
Fb-05	Motor Overload Detection Time	0.0~30.0s	5.0s	×	146
Fb-06	Motor Underload Protection	0: No action 1: Alarm 2: Fault and free shutdown	0	×	147
Fb-07	Motor Underload Protection Level	0.0~100.0%: the rated motor current is taken as 100%	30.0%	×	147
Fb-08	Underload Protection Detection Time	0.0~100.0s	1.0s	×	147
Fb-09	Analog Input Offline Action	0: No action 1: Alarm; operation at the average frequency during the 10s before offline 2: Alarm; operation at the analog input offline forced frequency 3: Fault and free shutdown	0	×	147
Fb-10	Analog Input Offline Forced Frequency	0.00Hz~F0-06“max. frequency”	0.00Hz	○	147
Fb-11	Other Protection Action Options	Units digit: Inverter input phase lack protection 0: No action 1: Alarm 2: Fault and free shutdown Tens digit: Inverter output phase lack protection 0: No action 1: Alarm 2: Fault and free shutdown Hundreds digit: Control panel offline	0022	×	148

Parameter	Name	Setting Range and Description	Factory settings	Modification	Page
		protection 0: No action 1: alarm 2: fault and free shutdown Thousands digit: Parameter storage failure action options 0: Alarm 1: Fault and free shutdown			
Fb-12	Acceleration Overcurrent Prevention Options Stall	0: Invalid 1: Valid; Abnormal shutdown will be reported in the event of a stall timetout (Er.Abb) 2: Valid; No time limit is set for stall	1	×	148
Fb-13	Acceleration Overcurrent Stall Point	10.0 ~ 130.0%; the rated inverter current is taken as 100%	110.0%	×	148
Fb-14	Constant Speed Overcurrent Prevention Options Stall	0: Invalid 1: Valid; Abnormal shutdown will be reported in the event of a stall timetout (Er.Abb) 2: Valid; No time limit is set for stall	1	×	148
Fb-15	Constant Speed Overcurrent Stall Point	10.0 ~ 110.0%; the rated inverter current is taken as 100%	110.0%	×	149
Fb-16	Overvoltage Prevention Options Stall	0: Invalid 1: Valid	1	×	149
Fb-17	Overvoltage Stall Point	650~750V	700V	×	149
Fb-18	DC Busbar Undervoltage Action	0: Free shutdown; an undervoltage fault is reported (Er.dCL) 1: Free shutdown; the time-limited power supply is restored and restarted 2: Free shutdown; the power supply is restored and restarted while the CPU is in operation 3: Decelerated operation; busbar voltage is maintained	0	×	150
Fb-19	DC Busbar Undervoltage Point	300~450V	380V	×	150
Fb-20	Instantaneous Power Failure Time Allowance	0.0~30.0s	0.1s	×	150
Fb-21	Instantaneous Power Failure Deceleration Time	0.0~200.0s; if the value is set as 0.0, the present deceleration time is adopted	0.0s	×	150
Fb-22	Fault Self-Reset Frequency	0~10; Module protection and external fault protection are not complete with the self-reset function.	0	×	151
Fb-23	Self-Reset Interval	1.0~30.0s	5.0s	×	151
Fb-24	Fault Output during Self-Reset	0: Output applicable 1: Output inapplicable	0	×	151
Fb-25	Restart Mode of Instantaneous Power	0: Startup in the startup mode 1: Tracking startup	1	×	151

Parameter	Name	Setting Range and Description	Factory settings	Modification	Page
	Failure, Self-Reset and Operation Suspension				
Fb-26	Poweron Self-Restart Enabled	0: Disabled 1: Enabled	1	○	152
Fb-27	Braking Unit Working Point	620~720V	680V	○	152
Fb-28	Modulation Mode	0: Auto modulation 1: Continuous modulation	0	○	153
Fb-29	Carrier Frequency	15kW and below: 1.1k ~ 12.0kHz; factory settings: 4.0kHz 18.5 ~ 160 kW: 1.1k ~ 8.0 kHz; factory settings: 2.5kHz 200kW and above: 1.1k ~ 5.0kHz; factory settings: 2.0kHz	Depend on inverter model No.	○	153
Fb-30	Random PWM Settings	0~30%	0%	○	153
Fb-31	Carrier Frequency Auto Adjustment Options	0: Disabled 1: Enabled	1	○	153
Fb-32	Deadband Compensation Enabled	0: Disabled 1: Enabled	1	×	154
Fb-33	Space Vector Angle Shutdown Memory	0: Memory inapplicable 1: Memory	0	×	154
Fb-34	Overmodulation Enablement	0: Disabled 1: Enabled	1	×	154
Fb-35	Cooling Fan Control	0: Auto operation 1: Uninterrupted operation	0	○	154
Fb-36	Width of Avoidance Frequency 1	0.00~625.00Hz	0.00Hz	○	155
Fb-37	Avoidance Frequency 1	0.00~20.00Hz	0.00Hz	○	155
Fb-38	Avoidance Frequency 2	0.00~625.00Hz	0.00Hz	○	155
Fb-39	Width of Avoidance Frequency 2	0.00~20.00Hz	0.00Hz	○	155
Fb-40	Avoidance Frequency 3	0.00~625.00Hz	0.00Hz	○	155
Fb-41	Width of Avoidance Frequency 3	0.00~20.00Hz	0.00Hz	○	155
Fb-42	Water Level Transducer Abnormality Options	0: No action 1: Alarm 2: Fault and free shutdown	0	○	156

---

Parameter	Name	Setting Range and Description	Factory settings	Modification	Page
Fb-43 ~ Fb-60		Retained	—	—	—

**FC: Keyboard Operation and Display Settings**

Parameter	Name	Setting Range and Description	Factory settings	Modification	Page
FC-00	Display Options	0: All parameters 1: User parameters 2: Those different from factory settings	0	○	156
FC-01	Key Functions and Auto Lock	<p>Units digit: Auto key lock</p> <p>0: Unlocked                      1: All locked</p> <p>2: All locked except (○)    3: All locked except (◀◀)</p> <p>4: All locked except (○) and (◀◀)</p> <p>5: All locked except (I) and (○)</p> <p>Tens digit: Function options for (○):</p> <p>0: Effective only when the command execution channel is the control panel</p> <p>1: Effective when the command execution channel is the control panel, terminal or communication port; the system is shut down in the shutdown mode</p> <p>2: When the control panel is the command execution channel, the system can be shut down in the shutdown mode; If a free shutdown is executed when the command execution channel is not the control panel, Er.Abb will be reported</p> <p>Hundreds digit: Function options for (◉) (applicable only to panel command channels):</p> <p>0: Ineffective                      1: Only effective in standby mode</p> <p>2: Effective in both standby mode and operation mode</p> <p>Thousands digit: Function options for (○) (applicable only to panel command channels)</p> <p>0: Operation</p> <p>1: Jog</p>	0000	×	156
FC-02	Monitoring Option 1	-1~50	1	○	157
FC-03	Monitoring Parameter 2	-1 means void; 0~50 mean FU-00~FU-50 which are used to select monitoring parameters displayed in both operation monitoring mode and standby monitoring mode	-1	○	157
FC-04	Monitoring Parameter 3		-1	○	157
FC-05	Monitoring Parameter 4	1~50	-1	○	157
FC-06	Monitoring Parameter 5	-1 means void; 0~50 mean FU-00~FU-50 which are used to select monitoring parameters displayed in both operation monitoring mode and standby monitoring mode	-1	○	157
FC-07	Monitoring Parameter 6		-1	○	157
FC-08	Monitoring Parameter 7		-1	○	157

Parameter	Name	Setting Range and Description	Factory settings	Modification	Page
FC-09	Operation Monitoring Parameter 1	-1~50 -1 means void; 0~50 mean FU-00~FU-50 which are used to select monitoring parameters displayed in operation monitoring mode	0	○	157
FC-10	Operation Monitoring Parameter 2		2	○	157
FC-11	Operation Monitoring Parameter 3		4	○	157
FC-12	Operation Monitoring Parameter 4		-1	○	157
FC-13	Rotation Speed Display Coefficient	0.001~10.000	1.000	○	158
FC-14	Linear Velocity Coefficient	0.01~100.00	0.01	○	158
FC-15	Units of PID Settings and Feedback Values (Applicable to LCD Panel)	0: Hz 1: A 2: V 3: % 4: kW 5: s 6: rpm 7: mps 8: m 9: mA 10: mV 11: Pa 12: kPa 13: °C 14: kg/cm <sup>2</sup> 15: mmH <sub>2</sub> O 16: MPa	14	○	158
FC-16 ~ FC-45	User Parameter 1 ~ User Parameter 30	-00.01—FU.50 (except Factory Settings Fn) -00.01 is void and the other are parameter numbers; for example, F0.01 means F0-01	-00.01	○	
FC-46	User Parameter 31	Fixed as FC-00 “Display Parameter Options”	FC.00	△	
FC-47	User Parameter 32	Fixed as F0-10 “Parameter Write Protection”	F0.10	△	

Table of User Parameters

n	1	2	3	4	5	6	7	8	9	10	11	12	13	14	15	16
User Parameter n	FC-16	FC-17	FC-18	FC-19	FC-20	FC-21	FC-22	FC-23	FC-24	FC-25	FC-26	FC-27	FC-28	FC-29	FC-30	FC-31
n	17	18	19	20	21	22	23	24	25	26	27	28	29	30	31	32
User Parameter n	FC-32	FC-33	FC-34	FC-35	FC-36	FC-37	FC-38	FC-39	FC-40	FC-41	FC-42	FC-43	FC-44	FC-45	FC-46	FC-47

**FF: Communcation Parameters**

Parameter	Name	Setting Range and Description	Factory Setting	Modification	Page
FF-00	Communication Protocol Options	0: Modbus 1: USS command 2: CAN	0	×	159
FF-01	Communication Data Format	0: 8,N,1 1: 8,E,1 2: 8,O,1 3: 8,N,2	0	×	195
FF-02	Baud Rate Options	0:1,200bps 1:2,400bps 2:4,800bps 3:9,600bps 4:19,200bps 5:38,400bps 6:57,600bps 7:115,200bps 8:250,000bps	3	×	159

Parameter	Name	Setting Range and Description	Factory Setting	Modification	Page
		9:500,000bps			
FF-03	Local IP Address	0~247	1	×	159
FF-04	Communication Timeout Detection Time	0.1~600.0s	10.0s	○	159
FF-05	Local Response Delay	0~1,000ms	5ms	○	159
FF-06	Communication Timeout Action	0: No action 1: Alarm 2: Fault and free shutdown 3: Alarm; press F0-00 for operation 4: Alarm; press F0-07 to operate at an upper frequency limit 5: Press F0-08 to alarm	0	×	159
FF-07	USS Message PZD Words	0~4	2	×	159
FF-08	Communication Frequency Setting Proportion	0.001~30.000	1.000	○	160

**Fn: Factory Settings**





Parameter	Name	Setting Range and Description	Factory settings	Modification
—	—	—	—	—

**FP: Fault Logs**

Parameter	Name	Setting Range and Description	Pages
FP-00	Type of Last Fault	0. No fault 1. ocb: Instantaneous startup overcurrent 2. ocA: Accelerated operation overcurrent 3. ocd: Decelerated operation overcurrent 4. ocn: Constant speed operation overcurrent 5. ouA: Accelerated operation overvoltage 6. oud: Decelerated operation overvoltage 7. oun: Constant speed operation overvoltage 8. ouE: Overvoltage on standby 9. dcL: Undervoltage in operation 10. PLI: Input phase lack 11. PLo: Output phase lack 12. FoP: Power device protection 13. oHI: Inverter overheat 14. oLP: Inverter overload 15. oLL: Motor overload 16. EEf: External fault 17. oLP: Motor overload 18. ULd: Inverter underload 19. cnF: Main loop contactor fault 20. cno: Water supply system contactor fault 21. EEP: Parameter storage failure 22. CFE: Communication abnormality 23. ccF: Current detection fault 24. LPo: Water level transducer abnormality 25. Aco: Analog input offline 26. PLL: Clean water pool water shortage 27. rHo: Thermal resistor open-circuit 28. Abb: Abnormal shutdown fault 29. Retained 30. Retained 31. PnL: Control panel offline	169
FP-01	Cumulative Operation Time during Last Fault	Min. unit: 1h	169
FP-02	Working frequency during Last Fault	Min. unit: 0.01Hz	169
FP-03	Frequency Settings during Last Fault	Min. unit: 0.01Hz	169
FP-04	Output Current during Last Fault	Min. unit: 0.1A	170
FP-05	Output Voltage during Last Fault	Min. unit: 0.1V	170
FP-06	Output Power during Last Fault	Min. unit: 0.1kW	170
FP-07	Busbar Voltage during Last Fault	Min. unit: 0.1V	170
FP-08	Inverter Bridge Temperature during Last Fault	Min. unit: 0.1°C	170
FP-09	Pump Status 1 during Last Fault	Ten thousands digit: #5 Thousands digit: #4 Hundreds digit: #3 Tens digit: #2 Units digit: #1	170

<b>Parameter</b>	<b>Name</b>	<b>Setting Range and Description</b>	<b>Pages</b>
FP-10	Pump Status 2 during Last Fault	Tens digit: Drainage pump      Units digit: Sleeping pump	170
FP-11	Type of Last but One Fault	The same designation as FP-00	170
FP-12	Cumulative Operation Time during Last but One Fault	Min. unit: 1h	170
FP-13	Type of Last but Two Fault	The same designation as FP-00	170
FP-14	Cumulative Operation Time during Last but Two Fault	Min. unit: 1h	170
FP-15	Type of Last but Three Fault	The same designation as FP-00	170
FP-16	Cumulative Operation Time during Last but Three Time	Min. unit: 1h	170
FP-17	Type of Last but Four Fault	The same designation as FP-00	170
FP-18	Cumulative Operation Time during Last but Four Time	Min. unit: 1h	170
FP-19	Single Operation Time during a Fault	Min. unit: 0.1h	170
FP-20	Fault Logs Cleared	11: Parameters in this menu are cleared and the settings automatically change to 00 upon completion.	170

**FU: Data Monitoring**

Parameter	Name	Setting Range and Description	Pages
FU-00	Working frequency	Motor rotation frequency; min. unit: 0.01Hz	172
FU-01	Frequency Settings	Unit indicator lamp flashes; min. unit: 0.01Hz	172
FU-02	Output Current	Min. unit: 0.1A	172
FU-03	Load Current Percentage	The rated inverter current is taken as 100%; min. unit: 0.1%	172
FU-04	Output Voltage	Min. unit: 0.1V	172
FU-05	Rotation Speed	Min. unit: 1r/min	172
FU-06	Rotation Speed Settings	Unit indicator lamp flashes; min. unit: 1r/min	172
FU-07	DC Busbar Voltage	Min. unit: 0.1V	172
FU-08	Output Power	Min. unit: 0.1kW	172
FU-09	Working Velocity Linear	Min. unit: 1m/s	172
FU-10	Linear Velocity Settings	Unit indicator lamp flashes; min. unit: 1m/s	172
FU-11	PID Feedback Value	Min. unit: 0.01	172
FU-12	PID Settings	Min. unit: 0.01	172
FU-13	AI1	Min. unit: 0.1%	172
FU-14	AI2	Min. unit: 0.1%	172
FU-15	AI3	Min. unit: 0.1%	172
FU-16	PFI	Min. unit: 0.1%	172
FU-17	UP/DOWN Adjustment	Unit indicator lamp flashes; min. unit: 0.1%	172
FU-18	Pump Status 1	Ten thousands digit: Pump #5    Thousands digit: Pump #4 Hundreds digit: Pump #3    Tens digit: Pump #2    Units digit: Pump #1 0: On standby 1: In variable-frequency operation 2: In line-frequency operation 3: In fault overhaul	172
FU-19	Pump Status 2	Tens digit: Drainage pump    Units digit: Sleeping pump    Same as FU18 (0~3)	172
FU-20	PID Output Value	Min. unit: 0.1%	173
FU-21	Radiator Temperature	Min. unit: 0.1°C	173
FU-22	Output Power Factor	Min. unit: 0.01	173
FU-23	kWh Meter Settings	0.0~6553.5kWh; hold  and  at one time to reset the parameters and the KWH timer	173
FU-24	KWH Timer	0.00~655.35h; hold  and  at one time to reset the parameters and the KWH timer	173
FU-25	Digital Input Terminal Status 1	Ten thousands digit: X5    Thousands digit: X4    Hundreds digit: X3    Tens digit: X2    Units digit: X1 0: OFF    1: ON	173
FU-26	Digital Input Terminal Status 2	Hundreds digit: REV    Tens digit: FWD    Units digit: X6 0: OFF    1: ON	173

FU-27	Digital Output Terminal Status	Tens digit: Y2 0: OFF	Units digit: Y1 1: ON	173
FU-28	Relay Output Terminal Status	Ten thousands digit: T5 0: OFF	Thousands digit: T4 Tens digit: T2 Unit digit: T1 1: ON	173
FU-29	Extension Digital Input Terminal Status	Ten thousands digit: X11 0: OFF	Thousands digit: X10 Hundreds digit: X9 Tens digit: X8 Units digit: X7 1: ON	173
FU-30	Extension Digital Output Terminal Status	Ten thousands digit: T10 Hundreds digit: T8/Y5 Units digit: T6/Y3	/Y7 Thousands digit: T9/Y6 Tens digit: T7 /Y4 0: OFF 1: ON	173
FU-31	Extension Digital Output Terminal Status	Relay T11 0: OFF	1: ON	173
FU-32	Communication Error Frequency	0~60,000		174
FU-33	Frequency Settings after Acceleration/Deceleration Ramp	Min. unit: 0.01Hz		174
FU-34	Output frequency	Frequency of inverter output voltage (factory settings); min. unit: 0.01Hz		174
FU-35 ~ FU-50		Retained		174

FC-16 ~ FC-45	User Parameter 1 ~ User Parameter 30	Factory Settings	-00.01	Modification	○
Setting Range	-00.01~FU.50; Except Fn (factory settings), -00.01 is void and others are parameter numbers. For example, F0.01 represents F0-01				
FC-46	User Parameter 31	Factory Settings	FC.00	Modification	△
FC-47	User Parameter 32	Factory Settings	F0.10	Modification	△

- 📖 User Parameters 1—30 are used to select parameters the user frequently uses or is concerned about. When FC-00=1, only these parameters are displayed. This function is especially suited for matching users;
- 📖 User Parameters 31 and 32 cannot be modified. They respectively indicate “display parameter settings” and “parameter write protection”.
- 📖 Instance: If F0.01 is set for FC-16, the first function of the user parameter will be F0-01. Then set FC-00 as 1. If the menu is accessed in the monitoring mode, only three parameters are displayed (F0-01, FC-00 and F0-1

## 6. Details about Function Parameters

### 6.1. F0: Basic Parameters

<b>F0-00</b>	<b>Digital Frequency Settings</b>	Factory Settings	50.00Hz	Modification	○
Setting Range	0.00Hz~F0-06“Max. Frequency”				
<b>F0-01</b>	<b>Main Setting Channel for Normal Operation</b>	Factory Settings	0	Modification	○
Setting Range	0: F0-00 adopts digital settings via the control panel adjustment (▲ and ▼) 1: Communication settings; F0-00 is used for initial value 2: UP/DOWN adjustment      3: AI2      4: AI2      5: AI3 AI1 6: PFI      7: Panel potentiometer (applicable only to SB-PU03)				

Refer to the following figures for frequency channel settings:

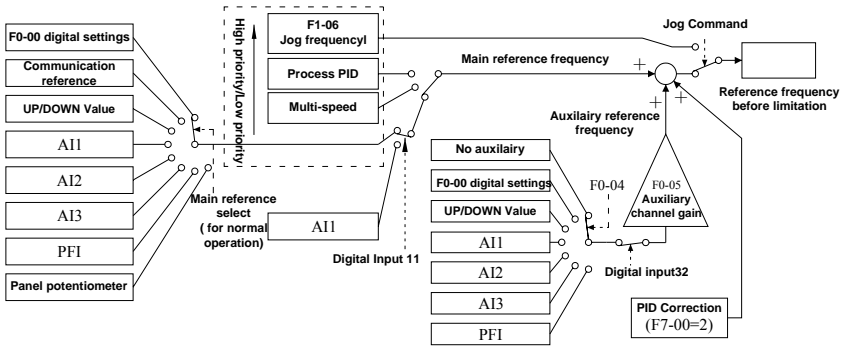



The inverter has four operation modes with the following priority levels (from high to low): jogging, process identification (PID), multi-speed and normal operation. For instance, if the multi-speed mode is effective in a normal operation, the main frequency settings will depend on the multi-band frequency.

📖 The main settings of normal operation may be selected via F0-01 “Main Setting Channel for Normal Operation”. Forced switching may be executed by digital input 11 (“Switching of frequency settings to AI1”). Refer to Page 53 for details.





📖 Define the auxiliary setting channel via F0-04 “Auxiliary Setting Channel Options”, or disable it via digital input 32 “auxiliary channel disabled”. Refer to Page 53 for details

📖 If F7-00 “PID control function options” is set as 2, the pre-ramp frequency settings may be

modified.

-  A jogging command means that a keyboard jogging via panel control is effective, or that a digital input 14 “Clockwise Jogging” or 15 “Anticlockwise Jogging” via terminal control is effective.
-  The final frequency settings will be subject to F0-07 “Upper frequency limit” and F0-08 “Lower frequency limit”.

<b>F0-02</b>	Command Execution Channel Options	Factory Settings	0	Modification	×
Setting Range	0: Control panel (EXT Extinguished) Communication Control (EXT Flashing)	1: Terminal (EXT Illuminated)		2:	

-  When the command execution channel is the control panel, press  to change direction. When power supply is on, the default direction is clockwise. The function of  is selected via the hundreds digit of FC-01.
-  Forced switching of the channel of command execution channel is enabled via digital input 42 “Switching of command execution channel to terminal or panel”. Refer to Page 54 for details.

F0-03	Frequency Setting Retention Mode	Factory settings	00	Modification	○
Setting Range	Units digit: 0: Upon poweroff, the main frequency settings modified via Poweroff storage communication or   will be stored to F0-00 option 1: Upon poweroff, the main frequency settings modified via communication or   will not be stored				
	Tens digit: 0: Upon shutdown, the main frequency settings modified via Shutdown communication or   will be retained retention options 1: Upon shutdown, the main frequency settings modified via communication or   will be restored to F0-00				

This parameter is effective only when F0-01 “Main setting channel for normal operation” is 0 or 1.

F0-04	Auxiliary Setting Channel Options	Factory Settings	0	Modification	○
Setting Range	0: Inapplicable 3: AI1 6: PFI 1: F0-00 “digital frequency settings” 2: UP/DOWN adjustment 5: AI3 4: AI2				
F0-05	Auxiliary Channel Gain	Factory settings	1.000	Modification	○
Setting Range	-1.000~1.000				

Refer to Page 43 for descriptions of F0-00 and F0-01.

F0-06	Max. Frequency	Factory Settings	50.00Hz	Modification	×
Setting Range	F0-07 “Upper Frequency Limit”~650.00Hz				
F0-07	Upper Frequency Limit	Factory Settings	50.00Hz	Modification	×
Setting Range	F0-08“Lower Frequency Limit”~F0-06“Max. Frequency”				
F0-08	Lower Frequency Limit	Factory Settings	0.00Hz	Modification	×
Setting Range	0.00Hz~F0-07 “Upper Frequency Limit”				

F0-06 “Max. Frequency”: This is the frequency corresponding with a frequency setting of 100%.

It is used for calibration for a frequency setting by analog input or PFI.

- 📖 F0-07 “Upper Frequency Limit”/F0-08 “Lower Frequency Limit”: Limits for the final frequency settings.

<b>F0-09</b>	<b>Direction Lock</b>	Factory Settings	0	Modification	○
Setting Range	0: Both clockwise direction and anticlockwise direction are applicable 1: Clockwise direction lock 2: Anticlockwise direction lock				

- 📖 It is recommended that the direction lock be used only for a single-direction rotation.
- 📖 If a direction change is required by turning  on the control panel, the hundreds digit of FC-01 must be set as 1 or 2.



<b>F0-10</b>	<b>Parameter Write Protection</b>	Factory Settings	0	Modification	○
Setting Range	0: Write protection inapplicable; all parameters are subject to rewriting except read-only parameters 1: No parameter is subject to rewriting except F0-00 “Digital Frequency Settings”, F7-04 “PID Digital Settings” and this parameter 2: No parameter is subject to rewriting except this parameter				

- 📖 This function prevents modification of parameters by error.

<b>F0-11</b>	<b>Parameter Initialization</b>	Factory Settings	00	Modification	×
Setting Range	11: Initialization 22: Initialization applicable to all parameters except communication parameters NOTE: The parameter automatically changes to 00 upon completion of initialization				

- 📖 Parameter initialization restores a parameter to factory settings and the fault logs are not restored (Fault logs may be cleared by FP-20).

<b>F0-12</b>	<b>Parameter Copying</b>	Factory Settings	00	Modification	×
Setting Range	11: Parameters are uploaded from the inverter to the panel 33: Conformity of the control panel to the inverter parameters is verified After verification, the parameter automatically changes to 00 22: Parameters are downloaded from the control panel to the inverter 44: Parameters stored in the control panel are cleared				

-  Parameter copying is a very useful function on occasions where more than one inverter adopts the same settings.
-  It is inadvisable to use the downloading function between inverters of different power ratings.
-  This function only applies to control panels integrating parameter coping (SB-PU70E and SB-PU200).



<b>F0-13</b>	<b>Rated Inverter Power</b>	Factory Settings	Depend on inverter model No.	Modification	△
--------------	-----------------------------	------------------	------------------------------	--------------	---

 Rated inverter power can be checked (min. value: 0.01kW).

<b>F0-14</b>	<b>Software Version</b>	Factory Settings	Depend on Version	Modification	△
--------------	-------------------------	------------------	-------------------	--------------	---

 Software version is verifiable; range: 0.00~99.99.

<b>F0-15</b>	<b>User Password Settings</b>	Factory Settings	0000	Modification	○
Setting Range	0000~9999; 0000 indicate an ineffective password				

 The password will become effective if there is no key operation within 2 minutes after the password is set. In the monitoring mode, press  and  to activate the password immediately.

**6.2. F1: Acceleration/Deceleration, Startup, Shutdown and Jog Parameters**

<b>F1-00</b>	<b>Acceleration Time 1</b>	Factory Settings	Depend on inverter model No.	Modification	○
<b>F1-01</b>	<b>Deceleration Time 1</b>	Factory Settings	Depend on inverter model No.	Modification	○
<b>F1-02</b>	<b>Acceleration Time 2</b>	Factory Settings	Depend on inverter model No.	Modification	○

<b>F1-03</b>	<b>Deceleration Time 2</b>	Factory Settings	Depend on inverter model No.	Modification	○
Setting Range	0.1~3600.0s Acceleration time: The time required to increase the frequency by 50Hz Deceleration time: The time required to decrease the frequency by 50Hz NOTE: Factory settings are 6.0s for 22kW inverter series and below and 20.0s for 30kW and above				
<b>F1-04</b>	<b>Deceleration Time in an Emergency Shutdown</b>	Factory Settings	10.0s	Modification	○
Setting Range	0.1~3600.0s				
<b>F1-05</b>	<b>Auto Switching Point for Acceleration/Deceleration Time</b>	Factory Settings	0.00Hz	Modification	×
Setting Range	0.00~650.00Hz; the range below this point is forced to be acceleration/deceleration time 2 (F1-02/F1-03)				

📖 F1-00~F1-03 provide 2 acceleration/deceleration time systems. Options may be made by digital input “7”. Refer to Page 52 for details.

📖 For the function of F1-05 “Auto Switching Point for Acceleration/Deceleration Time”, refer to the following figure. If auto segmented acceleration is not required, the parameter may be set as zero. The auto switching function for acceleration/deceleration is ineffective in the case of jog, emergency shutdown and stall prevention.

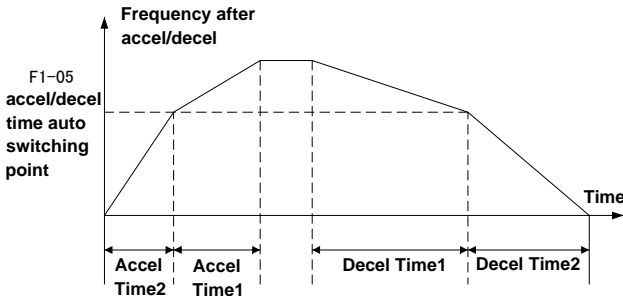

F1-04 “Deceleration Time in an Emergency Shutdown”: When Digital Input 16 is inputted or the communication port sends an emergency shutdown command, the inverter will shut down as indicated by “Deceleration time in an emergency shutdown”.

<b>F1-06</b>	<b>Jog Frequency</b>	Factory Settings	5.00Hz	Modification	○
Setting Range	0.10~50.00Hz				
<b>F1-07</b>	<b>Jog Acceleration Time</b>	Factory Settings	Depend on inverter model No.	Modification	○
<b>F1-08</b>	<b>Jog Deceleration Time</b>	Factory Settings	Depend on inverter model No.	Modification	○
Setting Range	0.1~60.0s NOTE: Factory settings for jog acceleration/deceleration time are 6.0s for 22kW inverter series and below Factory settings for jog acceleration/deceleration time are 20.0s for 30kW inverter series and above				

 In the panel control mode, set the thousands digit of FC-01 as 1 and **(I)** will be used for the jog; in the terminal control, standby mode, jogging will be enabled by Digital Inputs 14 “Clockwise Jog” and 15 “Anticlockwise Jog”. When both the signals are effective or ineffective, jog will not be enabled.

 In the jog mode, auxiliary settings and PID frequency modification are ineffective.

 The start/stop mode of a jog is fixed as startup at the startup frequency and shutdown in the deceleration mode.

<b>F1-09</b>	<b>Clockwise/Anticlockwise Rotation Deadband Time</b>	Factory Settings	0.0s	Modification	×
Setting Range	0.0~3600.0s				

 F1-09“Clockwise/Anticlockwise Rotation Deadband Time”: This means the latency time for switching between clockwise/anticlockwise rotations. The function used to dampen the impact of the switching between clockwise/anticlockwise rotations on the machine.

<b>F1-10</b>	<b>Startup Delay Time</b>	Factory Settings	0.0s	Modification	○
Setting Range	0.0~3600.0s; when an operation command is received, the latency settings will be effective in a latter time; when F8-00≠0, this parameter is ineffective				

 When selecting the water supply mode for the inverter, F1-10 “startup delay time” will be ineffective and the operation command will be immediately executed.

<b>F1-11</b>	<b>Startup Mode</b>	Factory Setting s	0	Modification	×
Setting Range	0: Startup from the startup frequency    1: DC braking comes before startup from the startup frequency    2: Startup in the rotation speed tracking mode				
<b>F1-12</b>	<b>Startup Frequency</b>	Factory Setting s	0.50Hz	Modification	○
Setting Range	0.00~60.00Hz				
<b>F1-13</b>	<b>Startup Frequency Maintenance Time</b>	Factory Setting s	0.0s	Modification	○
Setting Range	0.1~60.0s				
<b>F1-14</b>	<b>Startup DC Braking Time</b>	Factory Setting s	0.0s	Modification	○
Setting Range	0.0~60.0s				
<b>F1-15</b>	<b>Startup DC Braking Current</b>	Factory Setting s	0.0%	Modification	○
Setting Range	0.0~100.0%; the rated current of the inverter is taken as 100%				

 Inverter Startup Modes:

When F1-11=0, the inverter will start up from the startup frequency. After startup, the inverter will operate at the “startup frequency” (F1-12), which is maintained for a time set by F-13 “Startup Frequency Maintenance Time”. This is intended to reduce the impact current at startup.

When F1-11=1, the inverter will enforce a DC braking before startup from the startup frequency. In some cases where the motor is running upwind in an anticlockwise direction before startup, a DC braking may be enforced before startup to prevent a startup impact overcurrent. The parameter may be set via F1-14 “Startup DC Braking Time” and F1-15 “Startup DC Braking Current”.

When F1-11=2, the inverter will startup in a rotation speed tracking mode. The inverter will automatically identify the motor rotation speed/direction prior to motor startup and then start up the motor smoothly from the corresponding frequency without producing any impact. It is not necessary to wait until running motor stops thoroughly before enforcing a restart. You may minimize the startup time and impact.

 In the case of a restart during an instantaneous stop, self-reset or restart after an operation suspension, tracking startup may be enforced via Fb-25 “Restart Mode of Instantaneous Power

Failure, Self-Reset and Operation Suspension”.

Refer to the following figures for startup/shutdown DC braking:

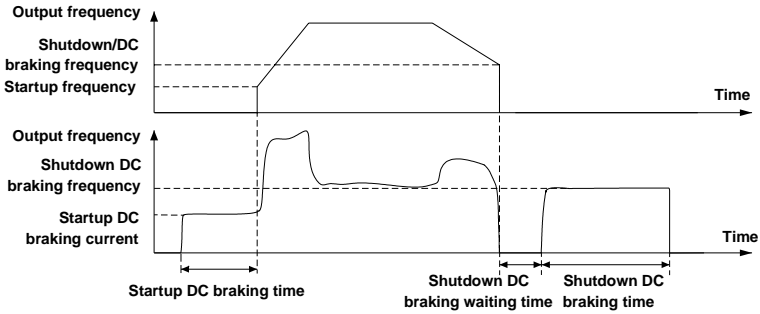

**NOTE:** It is inadvisable to restart after a prolonged DC braking in the event of a high-speed startup or startup with great-inertia loads. Tracking startup is recommended.

**NOTE:** If the inverter is started immediately after a free shutdown, the remanence of the counter-electromotive force will cause an overcurrent. Therefore, if the motor requires an immediate startup when it is still running after a free shutdown, tracking startup is recommended.

<b>F1-16</b>	Shutdown Mode	Factory Settings	0	Modification	○
Setting Range	0: Shutdown in deceleration mode    1: Free shutdown    2: Deceleration+ DC braking + DC Braking				
<b>F1-17</b>	<b>Shutdown/DC Braking Frequency</b>	Factory Settings	0.50Hz	Modification	○
Setting Range	0.00~60.00Hz				
<b>F1-18</b>	Shutdown DC Braking Latency Time	Factory Settings	0.00s	Modification	○
Setting Range	0.00~10.00s				
<b>F1-19</b>	Shutdown DC Braking Time	Factory Settings	0.0s	Modification	○
Setting Range	0.0~60.0s				
<b>F1-20</b>	Shutdown DC Braking Current	Factory Settings	0.0%	Modification	○
Setting Range	0.0~100.0%; the rated inverter current is taken as 100%				

**Inverter Shutdown Mode:**

When F1-16=0, the inverter will shut down in an deceleration mode: The working frequency will



become lower until the inverter changes into the standby mode when F1-17 “Shutdown/DC Braking Frequency” is actuated.

When **F1-16=1**, the inverter will have a free shutdown. The inverter will lock the output and the motor will slide freely to a shutdown. But if it is a jog shutdown or an emergency shutdown, the deceleration-mode shutdown will still be effective. Generally, a free shutdown is not recommended for water pumps, because the pump has a shorter shutdown time and a sudden shutdown may cause a water hammer effect.

When **F1-16=2**, the “shutdown in deceleration mode + DC Braking” will be effective. Upon receipt of the shutdown command, the inverter will decelerate; when F1-17 “shutdown/DC braking frequency” is actuated, the output will be clocked. After F1-18 “shutdown DC braking latency time”, provide a DC current for the motor as directed by F1-20 “Shutdown DC Braking Current”. After the settings for F1-19 “Shutdown DC Braking Time” are actuated, the motor will shut down. Please refer to Page 47 for startup/shutdown DC braking. The DC braking status will be maintained by digital input 34 “DC Braking Shutdown”. Refer to Page 53 for details.

 **CAUTION:** DC braking is recommended only for low-speed operation (10Hz and below) or small-power motors.

 **CAUTION:** In a DC braking, the mechanical energy of the load is transferred to the rotor. Frequent or longtime DC brakings may cause a motor overheat.

 In a command execution channel other than communication control, hold  and double-click  to enforce a free shutdown of the inverter, provided that the control panel is not locked.

**6.3. F2: V/F Control Parameters**

<b>F2-00</b>	<b>V/F Curve Settings</b>	Factory Setting	1	Modification	×
Setting Range	0: Custom (Refer to Parameters F2-14~F2-21) 2: V/F Curve 1 (Torque lowering; 1.2-th power) 4: V/F Curve 3(Torque lowering; 1.7-power) 6: V/F Curve 5(Torque lowering; 3.0-th power)	1: Linear V/F Curve (1.0-th power) 3: V/F Curve 2 (Torque lowering; 1.5-th power) 5: V/F Curve 4(Torque lowering; 2.0-th power)			

 V/F curves may be set as user-defined multisteps fold line, linearity and kinds reducing torque molds.

 V/F curves (torque lowering) can improve motor efficiency of fans and pumps when the torque lowering load is operating at a light load. For these loads, auto energy-saving modes can be applied to improve motor efficiency (refer to descriptions of F2-11 on Page 49).

 V/F curves (torque lowering) and auto energy-saving can reduce operation noise while improving

efficiency. Refer to the following figures for linear V/F curves and V/F curves (torque lowering):

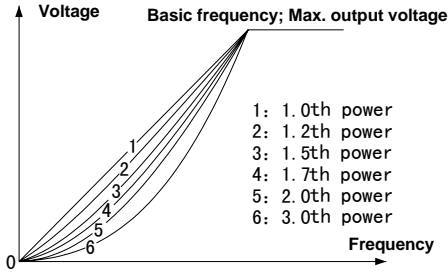

<b>F2-01</b>	<b>Torque Elevation Options</b>	Factory Setting s	1	Modification	×
Setting Range	0: Inapplicable 2: Auto torque elevation only 1: Manual torque elevation only 3: Manual torque elevation + auto torque elevation				
<b>F2-02</b>	<b>Amplitude of Manual Torque Elevation</b>	Factory Setting s	Depend on inverter model No.	Modification	○
Setting Range	15kW inverters and below: 0.0~15.0%, 0.0~10.0% F2-13 “max. output voltage” is taken as 100% 18.5kW inverters and above:				
<b>F2-03</b>	<b>Cut-Off Point of Manual Torque Elevation</b>	Factory Setting s	10.0%	Modification	○
Setting Range	0.0~100.0%; F2-12 “Basic frequency” is taken as 100%				
<b>F2-04</b>	<b>Auto Torque Elevation Range</b>	Factory Setting s	100.0%	Modification	×
Setting Range	0.0~100.0%				

Manual torque elevation can improve the low-speed torque and startup torque of the motor. Tune up F2-02 “Amplitude of Manual Torque Elevation” until the startup requirements are met. The amplitude value must not be too great, otherwise there will be motor overheating or overcurrent.

The relation curve of output voltage (V) and frequency (F) consists of a setup V/F curve, manual torque elevation and auto torque elevation. Please refer to the following figure for the relation between F2-03 “Cut-off point of auto torque elevation”, F2-12 “Basic frequency” and F2-13 “max. output voltage”:

Auto torque elevation can change the voltage real-time according to the load current intensity, compensate the voltage loss of the stator impedance, automatically adapt to different loads and

output appropriate voltage. This function can ensure larger output torque under heavy loads and smaller output currents under zero load.

Tracking startup, auto torque elevation and slip compensation involve some motor parameters.

Please confirm that these parameters conform to the parameters on the nameplate.

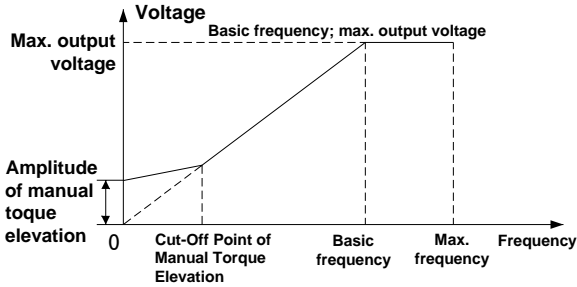

<b>F2-05</b>	<b>Slip Compensation Gain</b>	Factory Setting s	0.0%	Modification	○
Setting Range	0.0~300.0%				
<b>F2-06</b>	<b>Filter Time of Slip Compensation</b>	Factory Setting s	1.0s	Modification	×
Setting Range	0.1~25.0s				
<b>F2-07</b>	<b>Clipping of Electric Slip Compensation</b>	Factory Setting s	200%	Modification	×
<b>F2-08</b>	<b>Clipping of Regenerated Slip Compensation</b>	Factory Setting s	200%	Modification	×
Setting Range	0~250%; the rated motor slip frequency is taken as 100%				

Slip Compensation: If the output frequency remains unchanged, the load change may cause a slip change and the rotation speed will drop. Slip compensation supports online adjustment of the inverter’s output frequency according to load torque, minimizes change in rotation speed with load and improves speed control accuracy.

Slip compensation is effective in chases where auto torque elevation is enabled (when F2-01=2 or 3);

Slip compensation may be adjusted by F2-05 “Slip Compensation Gain”. It is recommended that the adjustment be done according to the drop of the rotation speed when the motor temperature is relatively stable under load operation. If the slip compensation gain is 100%, it means that the compensation value at the rated torque is the rated slip frequency.

Formula of Rated slip frequency: Rated slip frequency = Rated frequency — (Rated rotation speed

× Number of poles÷120)

 If the motor oscillates in the course of slip compensation, tune up F2-06 “Filter time of slip compensation”.

<b>F2-09</b>	<b>Vibration Dampening</b>	Factory Settings	Depend on inverter model No.	Modification	○
Setting Range	0~200				

 The oscillation of a motor under a zero or light load may be controlled by adjusting this parameter. Tune up the value to eliminate oscillation.

<b>F2-10</b>	<b>AVR Settings</b>		Factory Settings	1	Modification	×
Setting Range	0: Inapplicable	1: Always applicable	2: Only inapplicable in a deceleration			

 AVR means auto voltage regulation. This function ensures that the output voltage is stable when the input voltage or the DC busbar voltage oscillates, thus securing the production process and product quality.

 When the input voltage exceeds the rated value, enable AVR to prevent the motor from operating under too high a voltage.

 Compared with the “always applicable” mode, the “only inapplicable in the event of a deceleration” mode allows faster deceleration, but requires a larger deceleration current. This is because a deceleration causes the DC busbar voltage to rise. If the dead output voltage of AVR also increases, the loss of the motor also increases and the mechanical energy feedback is reduced. Therefore, the deceleration time is shorter.



 **CAUTION:** If the load has a very large rotary inertia, AVR must be set as “Always Applicable” to prevent a motor overheat caused by overvoltage in deceleration.

<b>F2-11</b>	<b>Auto Energy-Saving Options</b>	Factory Settings	0	Modification	○
--------------	-----------------------------------	------------------	---	--------------	---

Setting Range	0: Inapplicable	1: Applicable
---------------	-----------------	---------------

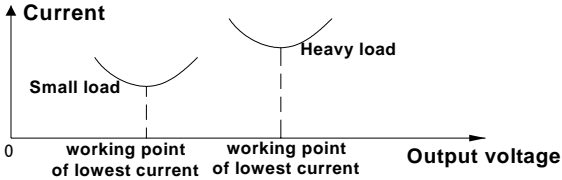
 Auto Energy-Saving Options: The output voltage is automatically adjusted to minimize the load current and motor loss at a constant rotation speed. This function is especially effective for such loads as fans and pumps with torque lowering characteristics. Refer to the following figures:



-  Auto energy-saving applies to stable loads only.
-  Auto energy-saving requires the application of auto torque elevation and slip compensation.

<b>F2-12</b>	<b>Basic Frequency</b>	Factory Setting	50.00Hz	Modification	×
Setting Range	1.00~650.00Hz				
<b>F2-13</b>	<b>Max. Output Voltage</b>	Factory Setting	380V	Modification	×
Setting Range	150~500V				
<b>F2-14</b>	<b>V/F Frequency F4</b>	Factory Setting	0.00Hz	Modification	×
Setting Range	F2-16“V/F Frequency F3”~F2-12“ Basic Frequency”				
<b>F2-15</b>	<b>V/F Voltage V4</b>	Factory Setting	0.0%	Modification	×
Setting Range	F2-17“V/F Voltage V3”~100.0%; F2-13“Max. Output Voltage” is taken as100%				
<b>F2-16</b>	<b>V/F Frequency F3</b>	Factory Setting	0.00Hz	Modification	×
Setting Range	F2-21“V/F Frequency F2”~F2-14“V/F Frequency F4”				
<b>F2-17</b>	<b>V/F Voltage V3</b>	Factory Setting	0.0%	Modification	×
Setting Range	F2-19“V/F Frequency V2”~F2-15“V/F Frequency V4”; F2-13“Max. Output Voltage” is taken as100%				

<b>F2-18</b>	<b>V/F Frequency F2</b>	Factory Settings	0.00Hz	Modification	×
Setting Range	F2-20“V/F Frequency F1”~F2-16“V/F Frequency F3”				
<b>F2-19</b>	<b>V/F Voltage V2</b>	Factory Settings	0.0%	Modification	×
Setting Range	F2-21“V/F Frequency V1”~F2-17“V/F Frequency V3”; F2-13 “max. output voltage” is taken as 100%				
<b>F2-20</b>	<b>V/F Frequency F1</b>	Factory Settings	0.00Hz	Modification	×
Setting Range	0.00Hz~F2-18“V/F Frequency F2”				
<b>F2-21</b>	<b>V/F Voltage V1</b>	Factory Settings	0.0%	Modification	×
Setting Range	0.0%~F2-19“V/F Voltage V2”; F2-13 “Max. Output Voltage” is taken as 100%				

Refer to the following figures for custom settings of the V/F curve:

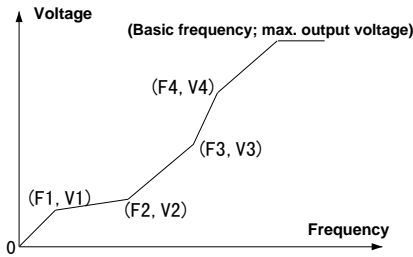

**6.4. F3: Motor Parameters**

<b>F3-00</b>	<b>Rated Frequency</b>	Factory Settings	Depend on inverter model No.	Modification	×
Setting Range	0.40~500.00kW				
<b>F3-01</b>	<b>Number of Poles</b>	Factory Settings	4	Modification	×
Setting Range	2~48				

<b>F3-02</b>	<b>Rated Current</b>	Factory Settings	Depend on inverter model No.	Modification	×
Setting Range	0.5~1200.0A				
<b>F3-03</b>	<b>Rated Frequency</b>	Factory Settings	50.00Hz	Modification	×
Setting Range	1.00~650.00Hz				
<b>F3-04</b>	<b>Rated Rotation Speed</b>	Factory Settings	Depend on inverter model No.	Modification	×
Setting Range	125~4000r/min				

 Prior to the operation of the inverter, input Parameters F3-00~F3-04 inscribed on the nameplate.

 When F8-00≠0 (water supply options), set up the rated current for pumps (F8-30~35).

**6.5. F4: Digital Input Terminals and Multi-Speed**

<b>F4-00</b>	<b>Functions of Digital Input Terminal X1</b>	Factory Settings	1	Modification	×
<b>F4-01</b>	<b>Functions of Digital Input Terminal X2</b>	Factory	2	Modification	×
<b>F4-02</b>	<b>Functions of Digital Input Terminal X3</b>	Factory	3	Modification	×
<b>F4-03</b>	<b>Functions of Digital Input Terminal X4</b>	Factory	12	Modification	×
<b>F4-04</b>	<b>Functions of Digital Input Terminal X5</b>	Factory	13	Modification	×
<b>F4-05</b>	<b>Functions of Digital Input Terminal X6/PFI/Pulse Frequency Input</b>	Factory	0	Modification	×
<b>F4-06</b>	<b>Functions of Digital Input Terminal X7 (Extension Terminal)</b>	Factory	0	Modification	×
<b>F4-07</b>	<b>Functions of Digital Input Terminal X8 (Extension Terminal)</b>	Factory	0	Modification	×
<b>F4-08</b>	<b>Functions of Digital Input Terminal X9 (Extension Terminal)</b>	Factory	0	Modification	×
<b>F4-09</b>	<b>Functions of Digital Input Terminal X10 (Extension Terminal)</b>	Factory	0	Modification	×
<b>F4-10</b>	<b>Functions of Digital Input Terminal X11 (Extension Terminal)</b>	Factory	0	Modification	×

<b>F4-11</b>	<b>Functions of FWD Terminal</b>	Factory	38	Modification	×
<b>F4-12</b>	<b>Functions of REV Terminal</b>	Factory	39	Modification	×
Setting Range	Refer to the following table for definitions of digital input functions				

☞ Table of Definitions of Digital Input Functions (The same function must not be selected for any two different digital input terminals)

0: Connection to the following signals is inapplicable	±20: UP/DOWN: Down	±40: Maintenance of Analog Frequency Settings
±1: Multi-band frequency option 1	±21: UP/DOWN: CLEAR	±41: Acceleration/Deceleration disabled
±2: Multi-band frequency option 2	±22: Check of Contactor 1K1	±42: Switching of command execution channel to terminal or panel
±3: Multi-band frequency option 3	±23: Check of Contactor 1K2	±43: Pump #1 disabled/Motor Option 1
±4: Check of upper water level limit of clean water pool	±24: Check of Contactor 2K1 of Contactor 2K2	±44: Pump #2 disabled/Motor Option 2
±5: Check of lower water level limit of clean water pool	±26: Check of Contactor 3K1	±45: Pump #3 disabled
±6: Check of water shortage level of clean water pool	±27: Check of Contactor 3K2	±46: Pump #4 disabled
±7: Acceleration/deceleration time option 2	±28: Check of Contactor 4K1	±47: Pump #5 disabled
±8: Multi-PID Option 1	±29: Check of Contactor 4K2	±48: Small sleeping pump disabled
±9: Multi-PID Option 2	±30: Check of Contactor 5K1	±49: Drainage pump disabled
±10: Multi-PID Option 3	±31: Check of Contactor 5K2	±50: Wastewater tank lower water level limit
±11: Switching of frequency settings to AI1	±32: Auxiliary setting channel disabled	±51: Wastewater tank upper water level limit
±12: External fault input	±33: Switching of PID settings to AI2	±52: Signal of upper water level limit
±13: Fault reset	±34: DC-braking shutdown	±53: Signal of lower water level limit
±14: Clockwise jog	±35: PID (Process identification) disabled	±54: Signal of firefighting system in operation
±15: Anticlockwise jog	±36: PID Parameter Option 2	
±16: Emergency shutdown	±37: Three-wire mode shutdown command	
±17: Inverter operation disabled	±38: Internal virtual FWD terminal	
±18: Free shutdown	±39: Internal virtual REV terminal	
±19: UP/DOWN: UP		

	±55: Priority pump startup option 1
	±56: Priority pump startup option 2
	±57: Priority pump startup option 3

- 📖 A negative value means that the terminal input is a high level or that the rising edge is effective. A positive value means that the terminal input has a low level, or that the falling edge is effective. If the same function is selected via F4-00 through F4-12, the setting with the greater parameter number is effective.
- 📖 SB200 is inbuilt with 8 multifunctional programmable digital input terminals (X1, X2, X3, X4, X5, X6, FWD and REV). Five other extension input terminals are also provided.
- 📖 Functions in the table of digital input functions may be selected by the digital input terminal. Also, the virtual input terminal, composed of the real-time clock module, can also be linked with the digital input functions in the table. Refer to the description of F9 for details.
- 📖 Related Monitoring Parameters: FU-25 (Digital Input Terminal Status 1) and FU-26 (Digital Input Terminal Status 2)
- 📖 Refer to the following detailed description of digital input functions:  
**0: Except when F4-05 = 0, connection of X6/PFI to other X terminals than PFI is inapplicable.**  
**1~3: Multi-Band Frequency Options: For coding, select Multi-Band Frequency 1—7.**  
**Refer to the following table, where “0” means effective and “1” means ineffective:**

Multi-Band Frequency Option 3	Multi-Band Frequency Option 2	Multi-Band Frequency Option 1	Multi-Band Frequency Selected
0	0	0	The frequency is set by the channel selected via F0-01
0	0	1	F4-20 Multi-Band Frequency 1
0	1	0	F4-21 Multi-Band Frequency 2
0	1	1	F4-22 Multi-Band Frequency 3
1	0	0	F4-23 Multi-Band Frequency 4
1	0	1	F4-24 Multi-Band Frequency 5
1	1	0	F4-25 Multi-Band Frequency 6
1	1	1	F4-26 Multi-Band Frequency 7

- 4~6: Check of Water Level of Clean Water Pool. Used for water shortage protection in constant-pressure water supply. See the description of F80-3 on Page 72.
- 7: Acceleration/Deceleration Time 2. If the signal is effective, select Acceleration/Deceleration Time 2. Acceleration/deceleration time for jog and emergency shutdown is ineffective.
- 8~10: Multi-PID Options 1-3. The three terminals are used to select the present PID settings via coding.**

Multi-PID Option 3	Multi-PID Option 2	Multi-PID Option 1	PID Settings Selected
0	0	0	Depend on F7-01 "Channel Setting Options"
0	0	1	F7-22 "Multi-PID Setting 1"
0	1	0	F7-23 "Multi-PID Setting 2"
0	1	1	F7-24 "Multi-PID Setting 3"
1	0	0	F7-25 "Multi-PID Setting 4"
1	0	1	F7-26 "Multi-PID Setting 5"
1	1	0	F7-27 "Multi-PID Setting 6"
1	1	1	F7-28 "Multi-PID Setting 7"

- 11: Switching of Frequency Settings to A11: When the signal is effective, the normal working frequency setting channel will be switched to A11 analog voltage/current setting. After the signal becomes ineffective, the frequency setting channel will be restored.
- 12: **External Fault Input:** This signal helps to input abnormality or fault information of inverter peripherals into the inverter, cause a shutdown and report an external fault. The signal can not be reset automatically. It can only be reset in the manual mode. NOMALLY OFF/ON may be inputted by setting positive/negative values. External faults may be indicated by digital output 10 "External Fault Shutdown" (Panel display: Er.EEF).
- 13: **Fault Reset:** The fault will be reset when the signal is an effective edge. The function is the same as the reset function of  on the control panel.
- 14~15: **Clockwise/Anticlockwise Jog: Refer to the description of the function of jog on Page 45.**
- 16: **Emergency Shutdown:** If this signal is effective, press F1-04 "Deceleration Time in an Emergency Shutdown" to shut down.
- 17: **Inverter Operation Disabled:** When this signal is effective, the inverter operation will be disabled. If the inverter is in operation, a free shutdown will be executed.
- 18: **Free Shutdown:** If the signal is effective when the inverter is in operation, the output will be locked immediately and the motor will shutdown in a freewheeling mode.
- 19~21: **UP/DOWN: UP, DOWN, CLEAR. Refer to the description of UP/DOWN on Page 56.**
- 22: **Check of Contactor 1K1: Used to check the contactor for Pump #1 variable frequency operation.**
- 23: **Check of Contactor 1K2: Used to check the contactor for Pump #1 line frequency operation.**
- 24: **Check of Contactor 2K1: Used to check the contactor for Pump #2 variable frequency operation.**
- 25: **Check of Contactor 2K2: Used to check the contactor for Pump #2 line frequency**

**operation.**

- 26: Check of Contactor 3K1: **Used to check** the contactor for Pump #3 variable frequency operation.
- 27: Check of Contactor 3K2: **Used to check** the contactor for Pump #3 line frequency operation.
- 28: Check of Contactor 4K1: **Used to check** the contactor for Pump #4 variable frequency operation.
- 29: Check of Contactor 4K2: **Used to check** the contactor for Pump #4 line frequency operation.
- 30: Check of Contactor 5K1: **Used to check** the contactor for Pump #5 variable frequency operation.
- 31: Check of Contactor 5K2: **Used to check** the contactor for Pump #5 line frequency operation.  
In the case of a constant-pressure water supply, verify if the contactor is in the indicated operation status by connection to the NORMALLY ON/OFF contacts of the pump control contactor. If the detected status of the contactor is different from the indicated status, a contactor fault of the water supply system will be reported (Er.cno). If there is a contactor fault, the water system will shut down to prevent the fault from escalation. Please rectify the fault immediately.
- 32: Auxiliary Setting Channel Disabled: If this signal is effective, the auxiliary setting function will be disabled.
- 33: **Switching of PID settings to AI2:** When this signal is effective, the PID setting channel will be switched to AI2 analog voltage/current settings in a forced mode. When this signal becomes ineffective, the PID setting channel will be restored to the channel assigned by F7-01.
- 34: **Shutdown DC-braking:** In the shutdown process, when the working frequency is lower than F1-17-“Shutdown/DC Braking Frequency” (and F1-16=2), if this signal is effective, the shutdown DC-breaking will be effective. The DC braking will not end until the braking time exceeds F1-19 and the command is repealed.
- 35: **Process Identification Disabled:** When this signal is effective, PID will be disabled. PID will not be enabled until this signal is ineffective and there is no other priority operation mode.
- 36: **PID Parameter 2 Options:** When F7-11 “PID parameter transition mode”=0 and is effective, choose PID Parameter 2 (F7-08~F7-10); when the parameter is ineffective, choose PID Parameter 1 (F7-05~F7-07).
- 37~39: **Three-wire mode shutdown command, Internal Virtual FWD Terminal and Internal Virtual REC Terminal:** Refer to the description of the F4-13 terminal operation mode on Page 55.
- 40: **Maintenance of Analog Quantity Frequency Settings:** If this signal is effective when the frequency settings is acquired by analog input, the frequency settings will not vary with the analog input. If this signal is ineffective, the frequency settings will vary with the analog

input. This function is very useful in cases where electromagnetic interference makes analog input commands susceptible to changes. Refer to the following figures:

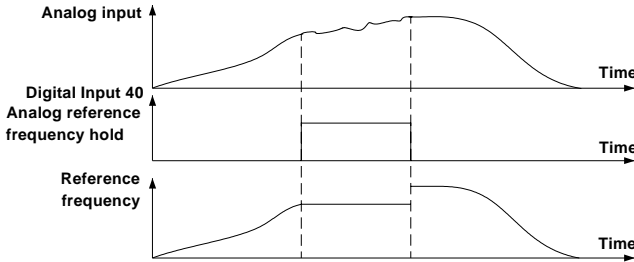

- 41: **Acceleration/Deceleration Disabled:** When this signal is effective, the acceleration/deceleration process of the inverter is stopped; when this signal is ineffective, the inverter will be restored to normal acceleration/deceleration operations.
- 42: **Switching of Command Execution Channel to Terminal or Panel:** The command channel may be switched with this signal according to F0-02. Refer to the following table:

F0-02 Command Execution Channel Options	Status of Digital Input 42	Command Execution Channel after Switching
0: Control Panel	Ineffective	Control Panel
	Effective	Terminal
1: Terminal	Ineffective	Terminal
	Effective	Control Panel
2: Communication	Ineffective	Terminal
	Effective	Control Panel

**43~44: Pump Disabled/Motor Options:** To meet the requirements of users of the SB200 inverter series which supports more than one motor of different capacities (non constant-pressure water supply mode), auto switching functions for motors in operation are required. In this case, different motor overload protection values have to be set.

- ±43: Pump #1 Disabled/Motor Option 1
- ±44: Pump #2 Disabled/Motor Option 2

In non-constant pressure water supply mode, the digital inputs of 43 and 44 are used as a motor option terminal to select the rated motor current and achieve different protection values.

Motor	Option	Current of Motor	Current of Motor	Current of Motor	Current of Motor
-------	--------	------------------	------------------	------------------	------------------

Terminal	#1(F3-02)	#2 (F8-30)	#3 (F8-31)	#4 (F8-32)
Motor Option 1	0	1	0	1
Motor Option 2	0	0	1	1

In the constant-pressure water supply mode, the rated current will be automatically selected for the corresponding pumps to achieve overload protection values. When the digital input is set as 43 and 44, the corresponding function is Pump Disabled Options

**45~49: Pump Disabled:** After the corresponding water pump disablement signal is inputted, an overhaul of an abnormal pump shutdown will be carried out. This function applies primarily to water pump overhaul and no manual shutdown of system operation is required.

After the water pump is overhauled, repeal the disablement command and the pump will be automatically started.

**50~51: Check of Waste Water Pool Level:** Refer to the description of F8-03 on Page 72.

**52~53: Water Level Control Detection Signal:** When the water supply mode is switched to water level control, the water pump will be started up or shut down according to the water level detection signal. When the lower limit signal is ineffective, the pump will be started; when the upper limit signal is effective, the pump will be shut down.

**54: Signal of Firefighting System in Operation:** When this signal is effective, the main pumps and auxiliary pumps are started and run at the max. capacity. No constant pressure control is executed. After the firefighting command is repealed, the system will be automatically restored to the original operation status.

**55~57: Priority Pump Startup Options:** When the tens digit of F8-39 is 0, the pump to be started first may be directly designated via the control terminal. The priority mode is only effective for a system in standby, constant-pressure mode.

Priority Startup Option 3	Pump	Priority Startup Option 2	Pump	Priority Startup Option 1	Pump	Sequence of Priority
0		0		0		#1 Water Pump
0		0		1		#1 Water Pump
0		1		0		#2 Water Pump
0		1		1		#3 Water Pump
1		0		0		#4 Water Pump
1		0		1		#5 Water Pump

F4-13	Terminal Operation Mode	Factory Settings	1	Modification	×
-------	-------------------------	---------------------	---	--------------	---





Setting Range	0: Single-wire mode (startup/shutdown) 1: Two-Wire Mode 1 (Clockwise/Anticlockwise) 2: Two-Wire Mode 2 (startup/shutdown and direction) 3: Two-Wire Mode (Startup/Shutdo wn) 4: Three-Wire Mode 1 (clockwise/anticlockwise and shutdown) 5: Three-Wire Mode 2 (Operation, direction and shutdown)
---------------	--

Digital input commands: 37 “Three-wire mode shutdown command”, 38 “Internal virtual FWD terminal” and 39 “Internal virtual REV terminal”.

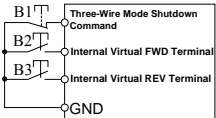
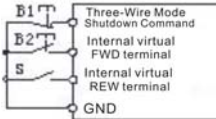
The following table lists the logics and diagrams of different operation modes. In this table, S means “level effective” and B means “Edge effective”:

F4-1 3	Mode Name	Operation Logic			Diagram
0	Single-Wire Mode (Startup/Shutdo wn)	S: Operation switch; operable when effective NOTE: The direction conforms to the direction of the frequency settings			
1	Two-Wire Mode 1 (Clockwise/Anticlockwise)	<b>S2 (Anticlockwise)</b>	<b>S1 (Clockwise)</b>	<b>Designation</b>	
		Ineffective	Ineffective	Stop	
		Ineffective	Effective	Clockwise	
		Effective	Ineffective	Anticlockwise	
		Effective	Effective	Stop	
2	Two-Wire Mode 2 (Startup/Shutdo wn and Direction)	<b>S2 (Direction)</b>	<b>S1 (Startup/Shutdo wn)</b>	<b>Designation</b>	
		Ineffective	Ineffective	Stop	
		Ineffective	Effective	Clockwise	
		Effective	Ineffective	Stop	
		Effective	Effective	Anticlockwise	
3	Two-Wire Mode 3 ( Startup/Shutdo wn)	B1: Start Button (NORMALLY ON) B2: OFF Button (NORMALLY OFF) NOTE: The direction conforms to the direction of the frequency settings			

F4-1 3	Mode Name	Operation Logic	Diagram
4	Three-Wire Mode 1 (Clockwise, Anticlockwise and Shutdown) Digital input 37 “Three-Wire Mode Shutdown Command” must be attached	B1: Stop Button (NORMALLY OFF) B2: Clockwise Button (NORMALLY ON) B3: Anticlockwise Button (NORMALLY ON)	
5	Three-Wire Mode 2 (Operation, Direction and Shutdown) Digital input 37 “Three-Wire Mode Shutdown Command” must be attached	B1: Stop Button (NORMALLY OFF) B2: Start Button (NORMALLY ON) S: Direction switch; anticlockwise when effective	

-  In the terminal control mode, whether single-wire mode ( 1 ) or two-wire mode (2), although they are both level-effective, the restart of the inverter after a shutdown caused by a shutdown command originating from other sources requires a shutdown signal prior to the emission of operation signal.
-  For Two-Wire Mode 3 or Three-Wire Mode, the start button will be ineffective when the NORMALLY OFF stop button is switched off.
-  Even if the operation mode defines the operation direction, the direction lock still overrides.
-  If the terminal command contains no information about direction, the operation direction will be determined by the frequency channel settings (Positive/Negative).



**CAUTION: When there is an operation signal and Fb-26 “Poweron Self-Restart Enabled”= 1**

**(factory settings), the inverter will start automatically after connection to power supply.**

F4-14	Debouncing Time of Digital Input Terminal	Factory Settings	10ms	Modification	○
Setting Range	0~2000ms				





-  **Debouncing Time of Digital Input Terminal:** This function is used to define the debouncing time of the digitally inputted signals. Signals with duration shorter than the debouncing time are negligible.

<b>F4-15</b>	<b>UP/DOWN Adjustment</b>	Factory Settings	0	Modification	○
Setting Range	0: Terminal Level mode    1: Terminal pulse mode    2: Control panel level mode    3: Control panel pulse mode				
<b>F4-16</b>	<b>UP/DOWN Rated/Step Length</b>	Factory Settings	1.00	Modification	○
Setting Range	0.01~100.00; min. settings: level mode: 0.01%/s; pulse mode 0.01%				
<b>F4-17</b>	<b>UP/DOWN Memory Options</b>	Factory Settings	0	Modification	○
Setting Range	0: Storage on poweroff    1: Reset on poweroff    2: Reset on shutdown or poweroff				
<b>F4-18</b>	<b>UP/DOWN Upper Limit</b>	Factory Settings	100.0%	Modification	○
Setting Range	0.0~100.0%				
<b>F4-19</b>	<b>UP/DOWN Lower Limit</b>	Factory Settings	0.0%	Modification	○
Setting Range	-100.0~0.0%				

📖 The UP/DOWN function realizes continuous adjustment. The adjustment value can be used for frequency settings and PID settings.

📖 **In the terminal level mode (F4-15=0)**, when the digital input 19 (UP/DOWN: UP) or 20 (UP/DOWN: DOWN) is effective, FU-17 (UP/DOWN adjustment) will rise or fall at the rate set by F4-16. When the digital inputs (19 and 20) are effective or ineffective at one time, the value of FU-17 will remain unchanged.

**In the terminal pulse mode (F4-15=1)**, when each effective pulse is generated by digital input 19 “UP/DOWN: UP” or 20 (UP/DOWN: DOWN), FU-17 (UP/DOWN Adjustment) will rise or fall by the step length set by F4-16.

**F4-15=2 or 3 is similar to F4-15=0 or 1.** The difference is that in the former case,  and  on the control panel is used to substitute 19 and 20 (digital inputs). Only when FU-17 “UP/Down Adjustment” is displayed can adjustments be made with  and .

📖 Refer to the two control modes for UP/DOWN in the following figure:

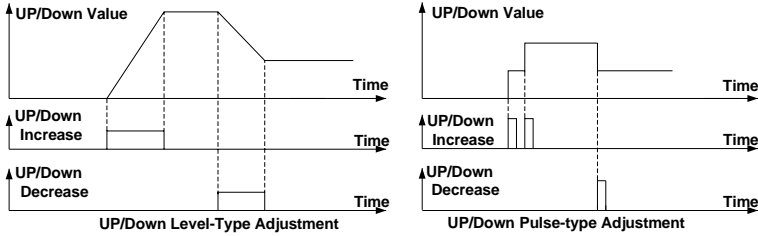

Digital Input 21 “UP/DOWN CLEAR”: This signal is used to clear FU-17 “UP/DOWN Adjustment” if it is an effective edge.

F4-20 ~ F4-26	<b>Multi-Band Frequency 1~7</b>	Factory Setting s	n.00Hz (n=1~7)	Modification	○
Setting Range	0.00~650.00Hz The factory settings of Multi-Band Frequency 1—Multi-Band Frequency 7 are their respective Multi-Band Frequency numbers. For example, the factory settings of Multi-Band Frequency 3 are 3.00Hz.				

For Multi-Band Frequency options, refer to Page 52 “Multi-Band Frequency Options”.

**6.6. F5: Digital Output and Relay Output Settings**

F5-00	<b>Functions of Digital Output Terminal Y1</b>	Factory Settings	1	Modification	×
F5-01	<b>Functions of Digital Output Terminal Y2</b>	Factory Settings	2	Modification	×
F5-02	<b>Output Functions of Relay Output T1</b>	Factory Settings	6	Modification	×
F5-03	<b>Output Functions of Relay Output T2</b>	Factory Settings	24	Modification	×
F5-04	<b>Output Functions of Relay T3</b>	Factory Settings	25	Modification	×
F5-05	<b>Output Functions of Relay T4</b>	Factory Settings	26	Modification	×
F5-06	<b>Output Functions of T5</b>	Factory Settings	27	Modification	×
F5-07	<b>Output Functions of T6/Y3 (Extension Output)</b>	Factory Settings	28	Modification	×
F5-08	<b>Output Functions of T7 /Y4 (Extension Output)</b>	Factory Settings	29	Modification	×
F5-09	<b>Output Functions of T8/Y5 (Extension Output)</b>	Factory Settings	30	Modification	×
F5-10	<b>Output Functions of T9 /Y6 (Extension Output)</b>	Factory Settings	31	Modification	×

F5-11	Output Functions of T10/Y7 (Extension Output)	Factory Settings	32	Modification	×
F5-12	Output Functions of T11/Y8 (Extension Output)	Factory Settings	33	Modification	×
Setting Range	0~59; refer to the following table of definitions of digital output functions				

📖 Related Monitoring Parameters: FU-27, FU-28, FU-30 and FU-31(Digital Output Terminal Status)

📖 Table of Definitions of Digital Output Functions

0: Inverter ready for operation	±21: Power generation process	±42: X9 (Extension terminal)
±1: Inverter in operation	±22: PC Digital Quantity 1	±43: X10 (Extension terminal)
±2: Frequency attained	±23: PC Digital Quantity 2	±44: X11 (Extension terminal)
±3: Output of Monitor 1	±24: Motor #1 in variable-frequency operation	±45: FWD
±4: Output of Monitor 2	±25: Motor #1 in line frequency operation	±46: REV
±5: Output of Monitor 3	±26: Motor #2 in variable frequency operation	±47: Pump ready for acceleration
±6: Fault output	±27: Motor #2 in line frequency operation	±48: Pump ready for deceleration
±7: Motor overload	±28: Motor #3 in variable-frequency operation	±49: Startup signal of auxiliary starter
±8: Motor overload	±29: Motor #3 in line frequency operation	±50: Working terminal of sleeping pump
±9: Undervoltage lockout	±30: Motor #4 in variable frequency operation	±51: Indication for sleeping operation
±10: Shutdown by external fault	±31: Motor #4 in line frequency operation	±52: Water shortage in suction pool
±11: Fault self-reset in process	±32: Motor #5 in variable frequency operation	±53: Abnormal closing of contactor
±12: Instantaneous poweroff/poweron in process	±33: Motor #5 in line frequency operation	±54: Drainage pump control
±13: Alarm output	±34: X1	±55: Water injection valve control for Pump #1
±14: Anticlockwise operation in process	±35: X2	±56: Air vent valve control for Pump #1
±15: Shutdown in process	±36: X3	±57: Water injection valve control for Pump #2
±16: Operation disabled	±37: X4	±58: Air vent valve control for Pump #2
±17: Under control of control panel	±38: X5	±59: Firefighting patrol in operation
±18: Output at a preset time	±39: X6	±60: A11>A13
±19: Upper frequency limit enabled	±40: X7 (Extension terminal)	
±20: Lower frequency limit enabled	±41: X8 (Extension terminal)	

📖 Refer to the following details about the digital output function:

**NOTE:** When the signal is effective, if the value is positive, the relay will be closed and Terminal Y will be connected to the transistor. If the value is negative, the relay will be open and Terminal Y will be disconnected from the transistor.

**0: Inverter ready for operation:** The energized contactor has been closed. There is no fault.

**1: Inverter in operation:** The inverter is in operation.

- 2: Frequency attained:** The function is effective when the operating frequency is within the positive/negative detection width of the frequency settings. Refer to F5-13 on page 60 for details.
- 3~5: Output of Monitors 1, 2 and 3:** Refer to F5-14~F5-20 on Page 60 for details.
- 6: Fault output:** An effective signal will be outputted if the inverter has a fault.
- 7: Motor overload:** The signal will be effective when the inverter detects a motor overload. Refer to Page 80 for details.
- 8: Motor overload:** The signal will be effective when the motor is overloaded. Refer to Page 79 for details.
- 9: Undervoltage lockout:** The signal will be effective when the DC busbar undervoltage causes a shutdown.
- 10: Shutdown by external fault:** The signal will be effective when an external fault causes a shutdown. The signal will be ineffective when the external fault is reset.
- 11: Fault self-reset in process:** The signal will be effective when the inverter is resetting after a fault.
- 12: Instantaneous poweron/poweroff in process:** The signal will be effective after the main loop has an undervoltage and is in the process of a restart.
- 13: Alarm output:** The signal will be effective when the inverter sounds an alarm.
- 14: Anticlockwise operation in process:** The signal will be effective when the inverter is in anticlockwise operation.
- 15: Shutdown in process.** The signal will be effective when the inverter is decelerating to a shutdown.
- 16: Operation disabled:** The signal will be effective when inverter operation is disabled.
- 17: Under control of control panel:** The signal will be effective when the command execution channel is the control panel.
- 18: Output at a preset time:** The option will be used when the clock module is used for output control. Refer to Page 78.
- 19: Upper frequency limit enabled:** The signal will be effective when the working frequency setting is equal to or exceeds the upper frequency limit.
- 20: Lower frequency limit enabled:** The signal will be effective when the working frequency reaches the lower frequency limit.
- 21: Power generation in process:** The inverter is in a power generation operating status.
- 22-23: PC Digital Quantities 1 and 2.**
- 24: #1 motor in variable frequency operation:** When the inverter is used for constant pressure water supply, the signal is used to control the contactor (variable-frequency operation) of Pump #1.
- 25: #1 motor in line frequency operation:** When the inverter is used for constant pressure water supply, the signal is used to control the contactor (line frequency operation) of Pump #1.
- 26: Motor #2 in variable frequency operation:** When the inverter is used for constant pressure water

supply, the signal is used to control the contactor (variable frequency operation) of Pump #2.

- 27: Motor #2 in line frequency operation:** When the inverter is used for constant pressure water supply, the signal is used to control the contactor (line frequency operation) of Pump #2.
- 28: Motor #3 in variable frequency operation:** When the inverter is used for constant pressure water supply, the signal is used to control the contactor (variable frequency operation) of Pump #3. If Pump #3 is an auxiliary pump that is directly started, the signal will be ineffective. If the pump is started by a soft starter, the signal will be used to switch Pump 3 to the soft starter.
- 29: Motor #3 in line frequency operation: When the inverter is used for constant pressure water supply, the signal is used to control the contactor (line frequency operation) of Pump #3.
- 30: Motor #4 in variable frequency operation:** When the inverter is used for constant pressure water supply, the signal is used to control the contactor (variable frequency operation) of Pump #4. If Pump #4 is an auxiliary pump that is directly started, the signal will be ineffective. If the pump is started by a soft starter, the signal will be used to switch Pump #4 to the soft starter.
- 31: Motor #4 in line frequency operation:** When the inverter is used for constant pressure water supply, the signal is used to control the contactor (line frequency operation) of Pump #4.
- 32: Motor #5 in variable frequency operation: When the inverter is used for constant pressure water supply,** the signal is used to control the contactor (variable frequency operation) of Pump #5.
- 33: Motor #5 in line frequency operation: When the inverter is used for constant pressure water supply, the signal is used to control the contactor of (line frequency operation) Pump #5. If Pump #5 is an auxiliary pump that is directly started, the signal is ineffective. If the pump is started by a soft starter, the signal will be used to switch Pump #5 to the soft starter.
- 34~39: X1~X6:** Digital input signals after debouncing.
- 40~44: X7~X11 (Extension terminal):** Extension digital input signals after debouncing.
- 45 and 46: FWD/REC:** Digital input signals after debouncing.
- 47: Pump ready for acceleration:** The signal will be effective when the inverter is used for constant pressure water supply. The signal will be outputted when the pump needs a boost.
- 48: Pump ready for deceleration:** The signal will be effective when the inverter is used for constant pressure water supply. The signal will be outputted when the pump needs deboost.
- 49: Startup signal of auxiliary starter:** The signal will be effective when the inverter is used for constant pressure water supply and the auxiliary pump is started by the soft starter. The signal is used to control the startup/shutdown of the soft starter. Refer to F801 “Pump Settings and Sleeping Options” on Page 71 for details.
- 50: Working terminal of sleeping pump:** The signal will be effective when the inverter is used for constant pressure water supply and there is a sleeping pump. The signal is used to control the sleeping pump. If the sleeping pump is in variable frequency operation, the signal will connect the sleeping pump to the inverter. If the sleeping pump is in line frequency operation, the signal will connect the sleeping pump to the line frequency power supply. Refer to F80-1 “Pump Settings and Sleeping Pump Options” on Page 71 for details.
- 51: Indication for sleeping operation:** The signal will be outputted when the pump is in

sleeping operation.

**52: Water shortage in suction pool:** The pump will be shut down when there is a water shortage in the suction pool. The signal will be outputted for an alarm and a shutdown will follow.

**53: Abnormal closing of contactor:** When the programmable digital terminal is used for contactor detection, if the status of the contactor is detected to be uncompliant with the control logic, the signal will be outputted for an alarm and a shutdown will follow.

**54: Drainage pump control:** The signal is outputted to control the startup/shutdown of the drainage pump via wastewater level detection.

**55: Water injection valve control for Pump #1.**

**56: Air vents valve control for Pump #1.**

**57: Water injection valve control for Pump #2**

**58: Air vents valve control for Pump #2**

If normal water supply is not detected when the pump is working at a variable frequency, the pipe may have air trapped within. Open the water injection valve and the air vent valve to inject water and displace air from the pipe. Refer to F8-42 Water injection valve/air vent valve control on Page 77.

**59: Firefighting patrol in operation:** If the inverter is used specifically for firefighting water supply, a periodic patrol will be conducted to inspect the pumps and this signal will be outputted. The signal is effective only when F8-00=4.

**60: AI1>AI3.** The status where AI1>AI3 is indicated.

<b>F5-13</b>	<b>Attainment of Frequency to Detection Width</b>	Factory Settings	2.50Hz	Modification	○
Setting Range	0.00~650.00Hz				



A frequency attainment signal will be emitted when the working frequency approaches the detection width of the frequency settings. See the following figure:

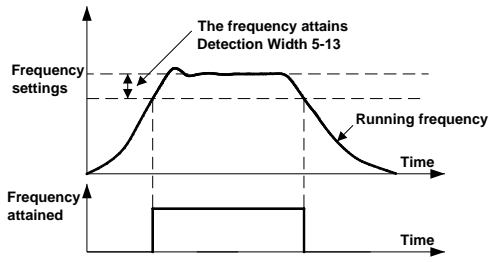

<b>F5-14</b>	<b>Monitors 1, 2 and 3 Options</b>	Factory Settings	000	Modification	○
Setting	Hundreds digit: Monitor 3	Tens digit: Monitor 2	Units digit: Monitor 1		

	0: Working frequency, Output Detection Mode 1 1: Working frequency; Output Detection Mode 2	2: PID feedback value, Output Detection Mode 1 3: PID feedback value, Output Detection Mode 2			
F5-15	Detected value of Monitor 1	Factory settings	20.00	Modification	<input type="radio"/>
F5-16	Detection lag value of Monitor 1	Factory settings	5.00	Modification	<input type="radio"/>
F5-17	Detected value of Monitor 2	Factory settings	40.00	Modification	<input type="radio"/>
F5-18	Detection lag value of Monitor 2	Factory settings	5.00	Modification	<input type="radio"/>
F5-19	Detected value of Monitor 3	Factory settings	60.00	Modification	<input type="radio"/>
F5-20	Detection lag value of Monitor 3	Factory settings	5.00	Modification	<input type="radio"/>
Setting Range	Frequency detection: The inputted parameter is the detected frequency. PID feedback value detection: The inputted parameter is the detected feedback value.				

When the monitored parameter is frequency and the working frequency exceeds the detected value, the digital output of “monitoring signal” is effective. The signal will be ineffective after the working frequency drops below the detected value-the detection lag value. Refer to the following figure:

When the monitored parameter is PID feedback value which is larger than the detected value, the digital output of monitoring signal is effective. The signal will be ineffective after the feedback value drops below the detected value-the detection lag value. Refer to the following figure:

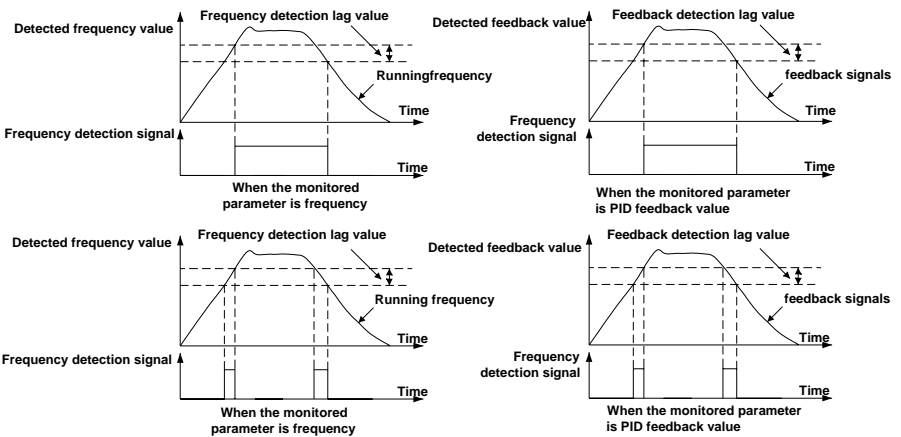

F5-21	Terminal Y1 Closing Delay	Factory settings	0.00s	Modification	○
F5-22	Terminal Y1 Opening Delay	Factory Settings	0.00s	Modification	○
F5-23	Terminal Y2 Closing Delay	Factory Settings	0.00s	Modification	○
F5-24	Terminal Y2 Opening Delay	Factory Settings	0.00s	Modification	○
Setting Range	0.00~650.00s				
F5-25	Terminal T1 Closing Delay	Factory Settings	0.00s	Modification	○
F5-26	Terminal T1 Opening Delay	Factory Settings	0.00s	Modification	○
F5-27	Terminal T2 Closing Delay	Factory Settings	0.00s	Modification	○
F5-28	Terminal T2 Opening Delay	Factory Settings	0.00s	Modification	○
F5-29	Terminal T3 Closing Delay	Factory Settings	0.00s	Modification	○
F5-30	Terminal T3 Opening Delay	Factory Settings	0.00s	Modification	○
F5-31	Terminal T4 Closing Delay	Factory Settings	0.00s	Modification	○
F5-32	Terminal T4 Opening Delay	Factory Settings	0.00s	Modification	○
F5-33	Terminal T5 Closing Delay	Factory Settings	0.00s	Modification	○
F5-34	Terminal T5 Opening Delay	Factory Settings	0.00s	Modification	○
Setting Range	0.00~650.00s				

 **Digital Output and Relay Output Delay:** Refer to the following figure:

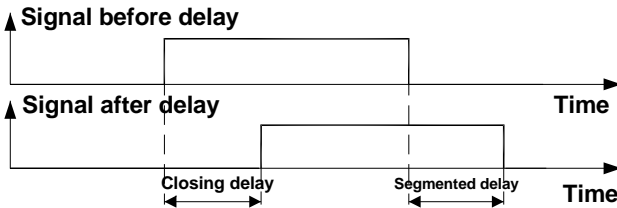

**CAUTION:** If the output terminals are 24~33, the closing/opening delay must be set as 0.00; Otherwise an unexpected consequence will occur.

6.7 F6: Settings of Analog Quantities and Pulse Frequency Terminals

<b>F6-00</b>	<b>All Min. Input Analog Quantity</b>	Factory Settings	0.00%	Modification	○
<b>F6-01</b>	<b>All Max. Input Analog Quantity</b>	Factory Settings	100.00%	Modification	○
Setting Frequency	-100.00—100.00%				
<b>F6-02</b>	<b>Set Value/Feedback Value Corresponding with All Min. Input Analog Quantity</b>	Factory Settings	0.00%	Modification	○
<b>F6-03</b>	<b>Set Value/Feedback Value Corresponding with All Max. Input Analog Quantity</b>	Factory Settings	100.00%	Modification	○
Setting Frequency	-100.00—100.00% NOTE: Frequency settings must be based on the max. frequency as a reference; the PID set value/feedback value must be represented as the percentage of the PID reference values				
<b>F6-04</b>	<b>Input analog Quantity of All Inflection Point</b>	Factory Settings	0.00%	Modification	○
Setting Frequency	F6-00 “Min. analog quantity”~F6-01 “Max. analog quantity”				
<b>F6-05</b>	<b>Deviation from All Inflection Point</b>	Factory Settings	2.00%	Modification	○
Setting Frequency	0.00~50.00%				
<b>F6-06</b>	<b>Set Value/Feedback Value Corresponding with All Inflection Point</b>	Factory Settings	0.00%	Modification	○
Setting Frequency	-100.00~100.00%				
<b>F6-07</b>	All Offline Threshold	Factory Settings	0.00%	Modification	○
Setting Frequency	-20.00~20.00%				
<b>F6-08</b>	All Input Filter Time	Factory Settings	0.100s	Modification	○
Setting Frequency	0.000~10.000s				
<b>F6-09</b>	<b>A12 Min. Input Analog Quantity</b>	Factory Settings	20.00%	Modification	○

<b>F6-10</b>	<b>AI2 Max. Input Analog Quantity</b>	Factory Settings	100.00%	Modification	○
Setting Frequency	-100.00~100.00%				
<b>F6-11</b>	Set Value/Feedback Value Corresponding with AI2 Min. Input Analog Quantity	Factory Settings	0.00%	Modification	○
<b>F6-12</b>	Set Value/Feedback Value Corresponding with AI2 Max. Input Analog Quantity	Factory Settings	100.00%	Modification	○
Setting Frequency	-100.00~100.00% NOTE: Frequency settings must be based on the max. frequency as a reference; the PID set value/feedback value must be represented as the percentage of the PID reference values				
<b>F6-13</b>	Input Analog Quantity of AI2 Inflection Point	Factory Settings	20.0%	Modification	○
Setting Frequency	F6-09 “Min. analog quantity”~F6-10“Max. analog quantity”				
<b>F6-14</b>	<b>Deviation from AI2 Inflection Point</b>	Factory Settings	2.00%	Modification	○
Setting Frequency	0.00~50.00%				
<b>F6-15</b>	Set Value/Feedback Value Corresponding with AI2 Inflection Point	Factory Settings	0.00%	Modification	○
Setting Frequency	-100.00~100.00%				
<b>F6-16</b>	AI2 Offline Threshold	Factory Settings	0.00%	Modification	○
Setting Frequency	-20.00~20.00%				
<b>F6-17</b>	AI2 Input Filter Time	Factory Settings	0.100s	Modification	○
Setting Frequency	0.000~10.000s				
<b>F6-18</b>	<b>AI3 Min. Input Analog Quantity</b>	Factory Settings	0.00%	Modification	○
<b>F6-19</b>	<b>AI3 Max. Input Analog Quantity</b>	Factory Settings	100.00%	Modification	○
Setting Frequency	-100.00~100.00%				
<b>F6-20</b>	Set Value/Feedback Value of AI3 Min. Input Analog Quantity	Factory Settings	0.00%	Modification	○

<b>F6-21</b>	Set Value/Feedback Value of AI3 Max. Input Analog Quantity	Factory Settings	100.00%	Modification	○
Setting Frequency	- 100.00~100.00% NOTE: Frequency settings must be based on the max. frequency as a reference; the PID set value/feedback value must be represented as the percentage of the PID reference values				
<b>F6-22</b>	Input Analog Quantity of AI3 Inflection Point	Factory Settings	0.00%	Modification	○
Setting Frequency	F6-18“Min. analog quantity”— F6-19“Max. analog quantity”				
<b>F6-23</b>	Deviation from AI3 Inflection Point	Factory Settings	2.00%	Modification	○
Setting Frequency	0.00~50.00%				
<b>F6-24</b>	Set Value/Feedback Value Corresponding with AI3 Inflection Point	Factory Settings	0.00%	Modification	○
Setting Frequency	-100.00—100.00%				
<b>F6-25</b>	<b>AI3 Offline Threshold</b>	Factory Settings	0.0%	Modification	○
Setting Frequency	- 20.00~20.00%				
<b>F6-26</b>	<b>AI3 Input Filter Time</b>	Factory Settings	0.100s	Modification	○
Setting Frequency	0.000~10.000s				

- 📖 The max./min. input analog quantity (-100.00—100.00%) corresponds with the voltage input of -10V—10V or the current signal of -20mA~20mA. The max./min. input analog quantity is the min. effective signal set or fed back. For example, If AI1 input signal is 0~10V and the actual demand is 2-8V in correspondence with 0~100.00%, F6-00=20.00 (20.00%) and F6-01=80.00 (80.00%). Likewise, if AI1 input is a current signal and actual demand is 4-20mA in correspondence with 0~100.00%, F6-00=20.00 (20.00%) and F6-01=100.00 (100.00%).
- 📖 Analog inputs AI1, AI2 and AI3 can be used to input current signals (-20mA—20mA) or voltage signals (-10V—10V)
- 📖 AI1, AI2 and AI3 have the same electrical properties and parameter settings. Take AI1 channel parameter for example:

Analog Input Example 1: (Factory settings of AI1 and AI3)

When most applications have an analog input voltage of 0~10V/0~20mA in correspondence with the set value/feedback value of 0~100%, the default factory settings can be directly applied. At this point, the input analog quantity at inflection point overlaps the min. input analog.

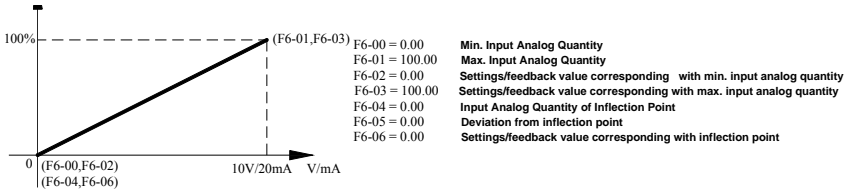

**Analog Input Example 2:**

In some applications where the analog input voltage is -10~10V/-20~20mA in correspondence with the set value/feedback value (0~100%), the parameter settings will be as follows:

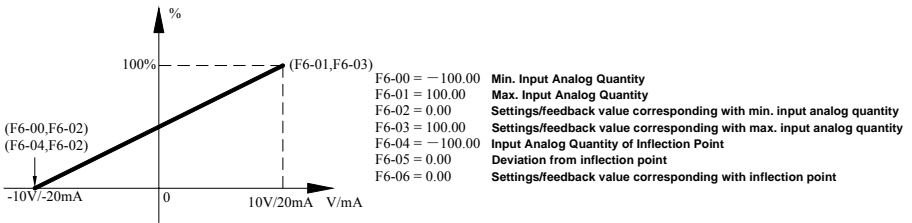

**Analog Input Example 3 (Factory settings of AI2):**

In most applications where the analog input voltage is 2~10V/4~20mA in correspondence with the set value/feedback value of 0~100%, the parameter settings will be as follows. At this point, the input analog quantity at inflection point overlaps the min. input analog quantity.

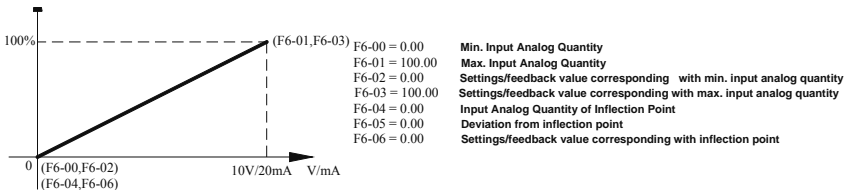

**Analog Input Example 4 (Application with offset):**

In some applications where the analog input voltage is 0~10V/0~20mA in correspondence with the set value/feedback value of 20~100%, the parameter settings will be as follows. At this point, the input analog quantity at inflection point overlaps the min. input analog quantity:

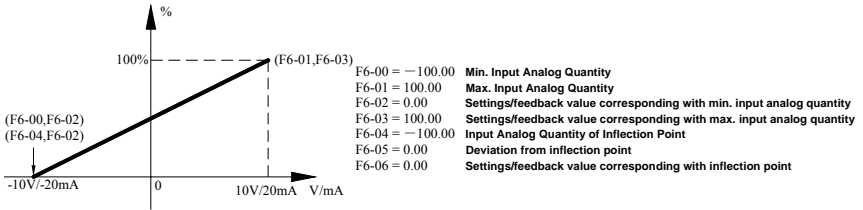

**Analog Input Example 5 (Reversed polarity application):**

In some applications where the analog input voltage is 0~10V/0~20mA in correspondence with the set value/feedback value of 100~0%, the parameter settings will be as follows. At this point, the input analog quantity at inflection point overlaps the min. analog input quantity.

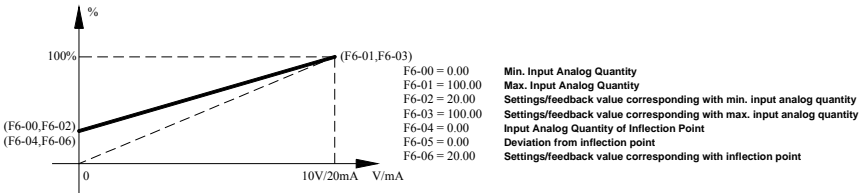

**Analog Input Example 6 (Application with inflection point):**

In some application where the analog input voltage is -10~10V/-20~20mA in correspondence with the set value/feedback value of -100~100%, the parameter settings will be as follows. In this case, when the analog input is used for frequency settings, the rotation direction of the motor will depend on the positive/negative feature of the input quantity. The inflection point settings are used for deadband settings in clockwise/anticlockwise rotation

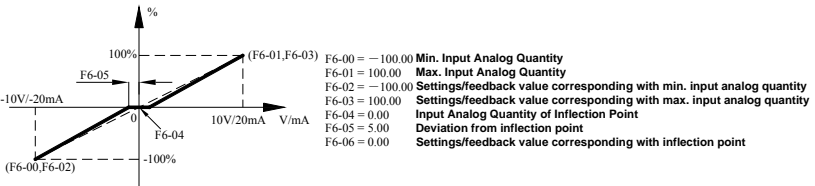

**Analog Input Example 7 (Application with inflection point):**

In some applications where the analog input voltage is 0~10V/0~20mA (split into two slope rates), the parameter settings will be as follows.

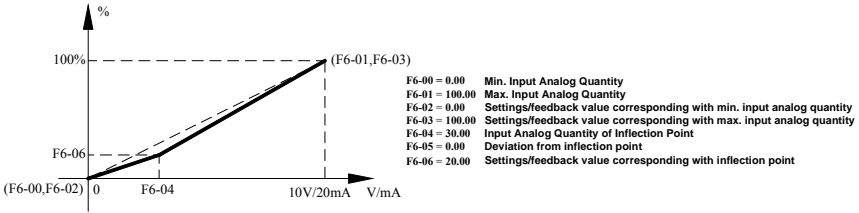

**Analog Input Example 8 (Application with inflection point):**

In some applications where the analog input voltage is 0~10V/0~20mA (split into two slope rates), the parameter settings will be as follows:

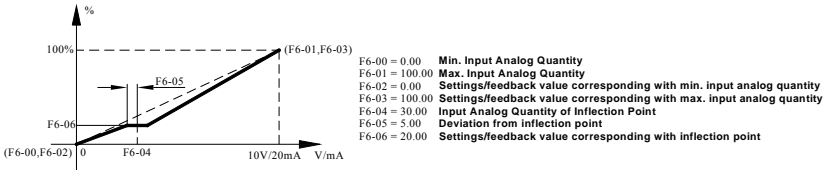

- 📖 All settings of AI2 and AI3 are identical to those of AI1.
- 📖 “Filter time”: If the filter time is increased, the response will be slower, but the anti-interference performance will be better; if the filter time is decreased, the response will be faster, but the anti-interference performance will be poorer.
- 📖 “Offline threshold”: When the analog input falls below the offline threshold, it is considered as an offline. An offline is confirmed by Fb-09 “Analog Input Offline Action”.

**NOTE:** If there are both positive and negative input signals, it’s impossible to judge whether there is an offline. If the offline threshold is set as 0, no offline judgment will be needed.

<b>F6-27</b>	<b>AO1 Function Options</b>	Factory Settings	0	Modification	○
Setting Range	Refer to the following table of definitions of analog input				
<b>F6-28</b>	<b>AO1 Type Options</b>	Factory Settings	0	Modification	○
Setting Range	0: 0~10V or 0~20mA    1: 2~10V or 4~20mA    2: 5V or 10mA is taken as the center				
<b>F6-29</b>	<b>AO1 Gain</b>	Factory Settings	100.0 %	Modification	○
Setting Range	0.0~1000.0 %				
<b>F6-30</b>	<b>AO1 Offset</b>	Factory Settings	0.00%	Modification	○
Setting Range	-100.00~100.00 %; 10V or 20mA is taken as 100 %				

<b>F6-31</b>	<b>AO2 Function Options</b>	Factory Settings	2	Modification	○
<b>F6-32</b>	<b>AO2 Type Options</b>	Factory Settings	0	Modification	○
<b>F6-33</b>	<b>AO2 Gain</b>	Factory Settings	100.0 %	Modification	○
<b>F6-34</b>	<b>AO2 Offset</b>	Factory Settings	0.00%	Modification	○
Setting Range	All settings of AO2 are the same as those of AO1				

Table of Definitions of Analog Output

0: Working Frequency (the max. frequency is taken as the full amplitude value)	8: AI1
1: Set frequency (the max. frequency is taken as the full amplitude value)	9: AI2
2: Output current (Two times the rated inverter current is taken as the full amplitude value)	10: AI3
3: Output voltage (1.5 times the rated inverter voltage is taken as the full amplitude value)	11: PFI
4: Output power (2 times the rated motor power is taken as the full amplitude value)	12: UP/DOWN adjustment
5: PID feedback value	13: DC busbar voltage (1000v is taken as the full amplitude value)
6: PID settings	14: The offset value is taken as the output value (the offset value must not be negative)
7: PID output value	

Refer to the following figure for the three types of analog output:

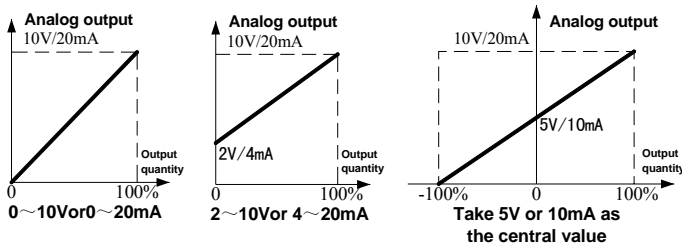

The gain and offset may be adjusted to change the measurement range and calibrate the zero point. Formula:  $Output = Output \times Gain + Offset$ .

Take the offset as the output value and a constant current (voltage) source (setting range: 0~20mA (0~10V)) will be available.



<b>F6-42</b>	PFO Duty Ratio Corresponding with 100%	Factory Settings	100.0%	Modification	○
<b>F6-43</b>	PFO Duty Ratio Corresponding with 0%	Factory Settings	0.0%	Modification	○
Setting Range	0.0~100.0%				

📖 PFO: The internal percentage signals are outputted as pulse frequency or duty ratio. Refer to the following figures:

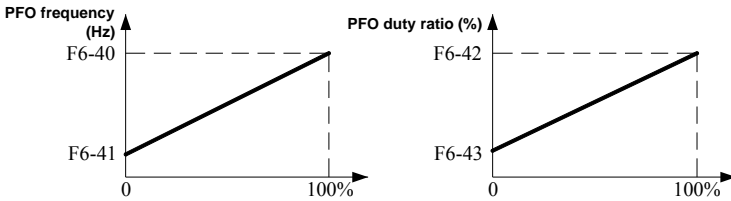

📖 In frequency modulation, the duty ratio is fixed at 50%; in duty ratio modulation, the pulse frequency is fixed at F6-40.

**6.8 F7: PID Parameters**

<b>F7-00</b>	<b>PID Control Function Options</b>	Factory Settings	0	Modification	×
Setting Range	0: PID control is not selected 1: PID control is selected (PID output takes the max. frequency as 100%) 2: PID is selected for frequency settings modification (PID output takes the max. frequency as 100%) 3: PID control is selected for frequency settings of constant pressure water supply				

📖 PID may be used to control such process variables as tension, pressure, flow rate, liquid level and temperature. To decrease deviation by proportional changing control function with deviation that are reacted by proportional elements; the integral element is used primarily to eliminate steady-state errors. The longer the integral time, the weaker the integral effect; the shorter the integral time, the stronger the integral effect. The differential element predicts the change of deviational signals by analyzing the trend of deviational changes. It also inhibits the control signals prior to deviational increase so as to improve the response speed of the control.

📖 If the PID control is selected for constant pressure water supply (F7-00=3) but the water supply function (F8-00) is not selected, the parameter settings will be ineffective (F7-00=0).

📖 Refer to the following figure for PID structure:

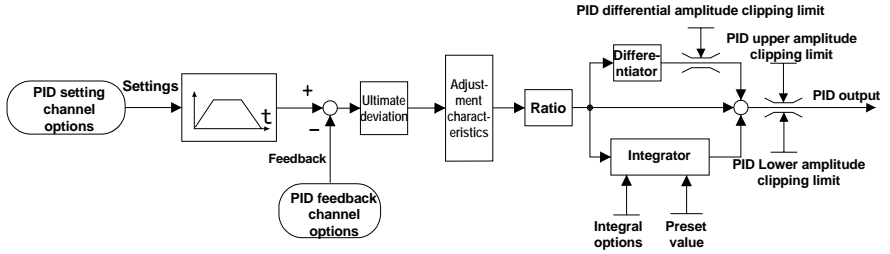

When PID is used for frequency correction, the inverter may be used in master-slave synchronization or tension control applications

Frequency Setting Correction: For correction, PID output is superimposed on the set frequency prior to the acceleration/deceleration ramp. Refer to the following figure:

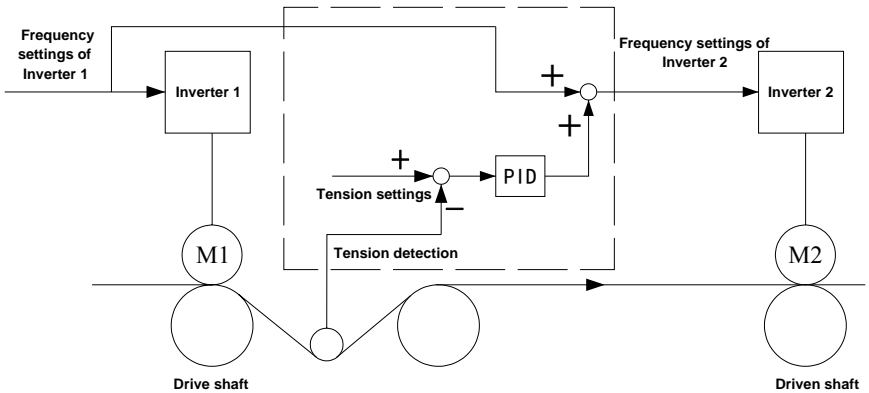

**Frequency Settings for Constant Pressure Water Supply:**

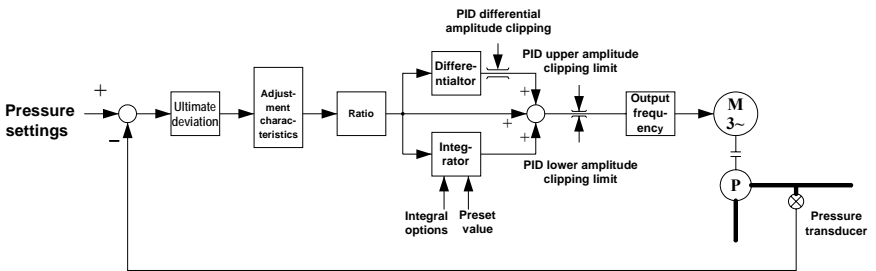

F7-01	Channel Setting Options	Factory Settings	0	Modification	×
-------	-------------------------	------------------	---	--------------	---

Setting Range	0: F7-04 1: AI1		2: AI2	3: AI3	4: UP/DOWN adjustment	
	5: PFI		6: Communication settings		7: AI - AI2 8: AI1 + AI2 9: Panel potentiometer	
<b>F7-02</b>	<b>Feedback Channel Option</b>		Factory Settings	0	Modification	×
Setting Range	0: AI1 1: AI2		2: AI3		3: AI1 - AI2	
	4: AI1 + AI2		5: $\sqrt{ AI1 }$		6: $\sqrt{ AI2 }$	
	8: $\sqrt{ AI1 } + \sqrt{ AI2 }$		9: PFI		10: MAX(AI1, AI3)	
					11: MIN(AI1, AI3)	
<b>F7-03</b>	<b>PID Reference Value</b>		Factory Setting	10.00	Modification	○
Setting Range	0.00 ~ 100.00 (transducer measurement range)					
<b>F7-04</b>	<b>PID Digital Settings</b>		Factory Setting	5.00	Modification	○
Setting Range	-F7-03 - F7-03					

- 📖 PID adopts normalized input/output. The input/output range is ±100%. Input calibration is related to feedback channel options, transducer characteristics and analog input settings. Input calibration takes the max. frequency as 100% in frequency control mode.
- 📖 Set channels and feedback channels have a filter process. For example, the filter time of AI1 is F6-08. The filter process affects control performances and may be configured as required by basic demand.
- 📖 In some mechanical applications (e.g. a centrifuge), the square root of the inlet pressure signal is linearly related to the flow rate. Flow rate control can be realized in the form of square root feedback.
- 📖 F7-03 “PID reference value”: The transducer measurement range is used for value settings. PID settings and feedback values are configured and displayed as actual values.

<b>F7-05</b>	<b>Proportional Gain 1</b>		Factory Settings	0.20	Modification	○
Setting Range	0.00 ~ 100.00					
<b>F7-06</b>	<b>Integral Time 1</b>		Factory Settings	20.00s	Modification	○
Setting Range	0.01 ~ 100.00s					
<b>F7-07</b>	<b>Differential Time 1</b>		Factory Settings	0.00s	Modification	○
Setting Range	0.00 ~ 10.00s					

<b>F7-08</b>	<b>Proportional Gain 2</b>	Factory Settings	0.20	Modification	○
Setting Range	0.00~100.00				
<b>F7-09</b>	<b>Integral Time 2</b>	Factory Settings	20.00s	Modification	○
Setting Range	0.01~100.00s				
<b>F7-10</b>	<b>Differential Time 2</b>	Factory Settings	0.00s	Modification	○
Setting Range	0.00~10.00s				
<b>F7-11</b>	<b>PID Parameter Transition Mode</b>	Factory Settings	0	Modification	×
Setting Range	0: Depend on Digital input 36 “PID Parameter Option 2. Refer to Page 54 1: Transition by working frequency 2: Transition by deviation				

The SB200 series have two PID parameter systems: PID parameters 1 (F7-05/F7-06/F7-07) and PID parameters 2 (F7-08/F7-09/F7-10). Parameter switching is available for digital input 36 “PID Parameter Option 2”. Also, gradual transition switching is available according to the working frequency or the percentage of the deviation between the settings and the feedback value. The two parameter systems are especially fit for winding control with a large winding diameter.

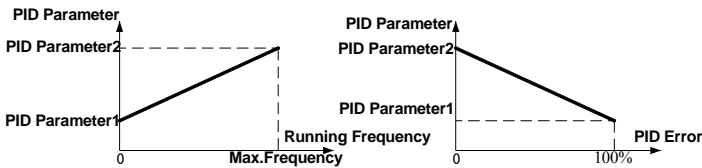

**PID Parameter Adjustment Principle:** Increase the proportional gain from a smaller value (0.20) until the feedback signal starts to oscillate and then reduce it by 40%-60% to stabilize the feedback signal. Decrease the integral time from a greater value (20.00s) until the feedback signal starts to oscillate and then increase it by 10%-50% to stabilize the feedback signal. If the system has a relatively high requirement on overshooting and dynamic error, differential action may be used.

<b>F7-12</b>	<b>Sampling Period</b>	Factory Setting	0.010s	Modification	○
Setting Range	0.001~10.000s				

**PID Sampling Period:** Generally, the settings should be 5 to 10 times smaller than the response



conditions, the rotational speed is required to be decreased (i.e. cooling control).

<b>F7-16</b>	<b>Integral Control Options</b>	Factory Settings	1	Modification	×
Setting Range	0: No integral action 1: Integral action				
<b>F7-17</b>	<b>PID Upper Amplitude Limit</b>	Factory Settings	100.0%	Modification	○
Setting Range	F7-18 “PID Lower Amplitude Limit”~100.0%				
<b>F7-18</b>	<b>PID Lower Amplitude Limit</b>	Factory Settings	0.0%	Modification	○
Setting Range	-100.0%~F7-17 “PID Upper Amplitude Limit”				
<b>F7-19</b>	<b>PID Differential Amplitude Clipping</b>	Factory Settings	5.0%	Modification	○
Setting Range	0.0~100.0%; clipping of the upper/lower amplitude limits of differential components				

📖 The user should clip PID amplitude as required. Appropriate clipping can reduce overshooting and prevent overlarge controlled quantities.

<b>F7-20</b>	<b>PID Preset Value</b>	Factory Settings	0.0%	Modification	○
Setting Range	F7-18 “PID lower amplitude limit”~F7-17 “PID Upper amplitude limit”				
<b>F7-21</b>	<b>PID Preset Value Hold Time</b>	Factory Settings	0.0s	Modification	×
Setting Range	0.0~3600.0s				

📖 PID Presetting: PID output will be maintained at the preset value within the preset maintenance time. It corresponds with an open-loop control. Upon completion of the preset stage, the integrator initial value of PID is the preset value and PID closed-loop control becomes effective. Refer to the following figures:

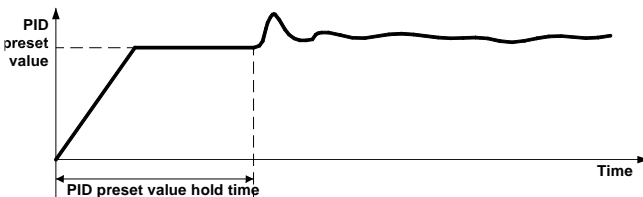

 If the preset value maintenance time is set as zero, PID control will be conducted upon taking the preset value as the initial value of the integrator. It corresponds with the preload of PID and is used to improve the response speed at the startup stage.

F7-22	Multi-PID Setting 1	Factory Settings	1.00	Modification	○
F7-23	Multi-PID Setting 2	Factory Settings	2.00	Modification	○
F7-24	Multi-PID Setting 3	Factory Settings	3.00	Modification	○
F7-25	Multi-PID Setting 4	Factory Settings	4.00	Modification	○
F7-26	Multi-PID Setting 5	Factory Settings	5.00	Modification	○
F7-27	Multi-PID Setting 6	Factory Settings	6.00	Modification	○
F7-28	Multi-PID Setting 7	Factory Settings	7.00	Modification	○
Setting Range	-F7-03 – F7-03				

 For multi-PID control applications, refer to Digital Inputs 8, 9 and 10 “Multi-PID Options 1~3” on Page 53.

**6.9. F8: Dedicated Water Supply Functions**

F8-00	Water Supply Mode Options	Factory Settings	0	Modification	×
Setting Range	0: Water supply function is not selected 1: Common PI-regulated constant-pressure water supply 2: Water level control 3: Pumps are started on by one in the sequence based on water pump capacity 4: Firefighting water supply				

 When F8-00=1, common PI-regulated constant-pressure water supply will be effective. The inverter samples from pressure signals and adopt PI regulator calculation to determine the output frequency of the inverter. Thus the rotation speed of the water pump is adjusted to realize constant pressure water supply. If any firefighting operation command is inputted, the water

pump will be quickly started at the preset acceleration time. At this point, the output frequency will not be set by the PID regulator.

 **When F8-00, water level control is effective:** In water level control mode, the inverter will enter the standby mode after receipt of execution commands and start up or shut down the water pump according to water level signals (digital inputs 52 and 53; refer to Page 55). In operation, the main pump and the auxiliary pump operate at full speed.







 **When F8-00=3,** pumps are started on by one in the sequence based on water pump capacity. The system prescribes the min. capacity for Pump #1 (Pump #1<Pump #2<Pump #3...). When the pump of a smaller capacity attains to the upper frequency limit, if the pressure is lower than the settings, the current pump will be shut down and the pump of a larger capacity will be started up. When the pump of a larger capacity is operating at a lower frequency limit and the pressure is higher than the settings, the current pump will be shut down and the pump of a smaller capacity will be started. In the case of a single pump in constant pressure operation, the working frequency is set by the PID regulator.

 **CAUTION: In the working mode where F8-00 = 3, the settings for auxiliary pumps are ineffective.**



 **When F8-00=4, firefighting water supply is selected.** When firefighting water supply is selected, regular patrols must be organized on a regular basis to prevent longtime disuse from causing rusts. When the firefighting operation command is inputted, the system will quickly start all the pumps at the largest water supply capacity. In this mode, the output frequency is not set by the PID regulator.

<b>F8-01</b>	Water Pump Settings and Sleeping Options	Factory Settings	00001	Modification	×
Setting Range	Units digit: Number of variable-frequency cyclic switchover pumps: 1~5				
	Tens digit: Number of auxiliary pumps : 0~4				
	Hundreds digit: Startup mode of auxiliary pumps 0: Direct startup                      1: Startup by soft starter				
	Thousands digit: Sleeping and sleeping pump options 0: The sleeping pump is not selected      1: The sleeping pump works at a variable frequency      2: The sleeping pump works at a line frequency      3: The main pump is in sleeping mode				
	Ten thousands digit: Drainage pump options 0: Drainage pump not under control                      1: Drainage pump under control				

 **Number of variable-frequency cyclic switchover pump s(main pumps):** These are pumps capable of both variable-frequency operation and line-frequency operation. The max. number is 5 pumps.

-  **Number of auxiliary pumps:** These are pumps working only at a line frequency.
-  **Startup mode of auxiliary pumps:** “0” means direct startup. It is suitable for only pumps of a smaller power (30kW and below). “1” means startup by soft starter. A pump of a larger capacity must not be directly started at a line frequency; rather, a soft starter is required and digital output or relay output must be configured to control the startup/shutdown of the soft starter. Refer to the table of definitions of digital output functions on Page 58.
-  **CAUTION:** The number of main pumps and auxiliary pumps must be configured according to the number of relays. The inverter has 5 inbuilt relays and expansibility allows for 11 relays in all (Main pumps + Auxiliary pumps ≤ 5). When the total number of main pumps and auxiliary pumps exceeds 5, the number of auxiliary pumps = 5 – Number of main pumps (The system configures the main pumps as a priority. For example, if there are 2 main pumps and 2 auxiliary pumps, the serial number of the main pumps will be #1 and #2 and the serial number of the auxiliary pumps will be #3 and #4).
-  **Sleeping and sleeping pump options:** Pumps with a smaller capacity than the main pump are used as the sleeping pump. If the water consumption is very small, the sleeping pump is a more energy-saving option. Refer to the description of the sleeping function on Page 75.
-  **Drainage pump option:** A liquid level detector or transducer is installed for the wastewater pool to control the operation of the drainage pump.
-  Refer to the application cases in Chapter X

<b>F8-02</b>	Fault and PID Lower Limit Options	Factory Setting s	00	Modification	×
Setting Range	Units digit: PID lower limit options 0: Operation shutdown      1: Operation maintained				
	Tens digit: Fault action options 0: All pumps are shut down and in fault status 1: The pump in line frequency operation resumes operation after a fault reset 2: The pump in line frequency operation are on standby after a fault reset				

-  **PID lower limit options:** When “0: operation shut down” is selected, if a single pump is operating at a lower frequency limit but the feedback value is still greater than the set value, the pump will stop operation. In some cases, the shutdown of all pumps is not allowed. Even if a single pump is working at a lower frequency limit but the feedback value is still greater than the set value, “1: operation maintained” must be set.
-  **Fault action options:** Several action options are provided. If 1 or 2 is selected, in the case of an inverter fault or an external fault, the pump already working at a line frequency will be maintained in operation. When the contactor detects a fault, this function will be ineffective.

<b>F8-03</b>	Clean Water Pool/Waste Water Pool Level Signal Options	Factory Settings	00	Modification	○
--------------	--	------------------	----	--------------	---

Setting Range	Tens digit: Waste water pool signal options Units digit: Clean water pool signal options 0: Water level signal is not subject to detection 1: Analog signal AI1 input                      2: Analog signal AI2 input 3: Analog signal AI3 input                      4: Digital signal input				
<b>F8-04</b>	<b>Clean Water Pool Lower Level Limit Signal</b>	Factory Settings	30.0%	Modification	○
<b>F8-05</b>	<b>Clean Water Pool Upper Level Limit Signal</b>	Factory Settings	80.0%	Modification	○
<b>F8-06</b>	<b>Clean Water Pool Water Shortage Signal</b>	Factory Settings	50.0%	Modification	○
Setting Range	0.0~100.0%				
<b>F8-07</b>	<b>Pressure Settings for Clean Water Pool at the Time of Water Shortage</b>	Factory Settings	4.00	Modification	○
Setting Range	-F7-03~F7-03				
<b>F8-08</b>	Waste Water Pool Lower Level Limit Signal	Factory Settings	30.0%	Modification	○
<b>F8-09</b>	Waste Water Pool Upper Level Limit Signal	Factory Settings	80.0%	Modification	○
Setting Range	0.0—100.0%				

 **Clean Water Pool Level Signals:** Water level detection may be operated via a liquid level transducer or an external liquid level detector. F8-04, F8-05 and F8-06 are respectively used to set the lower limit signal, upper limit signal and water shortage for the clean water pool. When the water level drops below the water shortage level, the inverter will automatically switch to F8-07 (Pressure Settings for Clean Water Pool at the Time of Water Shortage) for operation. This is intended to prevent max. operation capacity in the case of a water shortage which may cause unnecessary loss. When the water level signal is lower than the lower water level limit signal, the system will stop operation and report a water shortage fault. If digital input is selected, any three digital input terminals are used as liquid level input terminals and respectively set as “water level detection signals for Clean Water Pools 4, 5 and 6”.

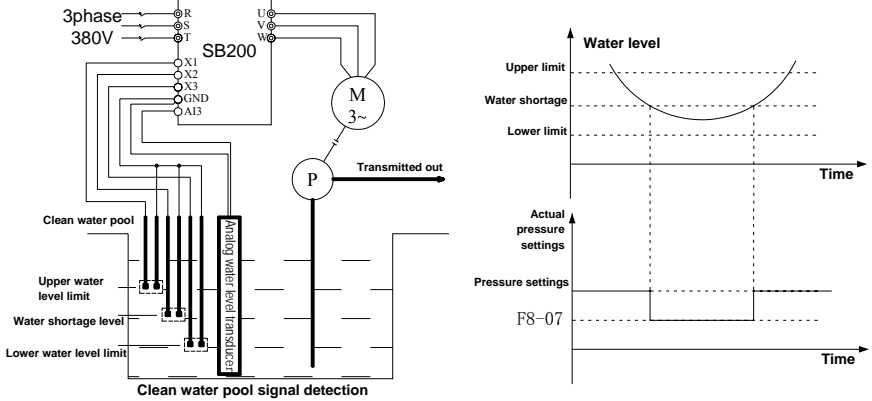

**Waste Water Pool Level Signals:** Water level detection may be operated via a liquid level transducer or an external liquid level detector. F8-08 and F8-09 are respectively used to set the lower limit signal and upper limit signal for the waste water pool. When the wastewater reaches the upper level limit, the drainage pump will automatically start (the pump and the corresponding control relays must be configured). When the water level drops to the water shortage level, the drainage pump will shut down. If digital input is selected, any two digital input terminals are used as liquid level input terminals and respectively set as “water level detection for Waste Water Pools 50 and 51”.The connection for signals requires only two common water level probes (hard copper wires are recommend as a substitute), which are fixed in the waste water pool. Refer to the following figure. Three lead-out wires connected to the programmable digital input terminal of the inverter will realize water level detection.

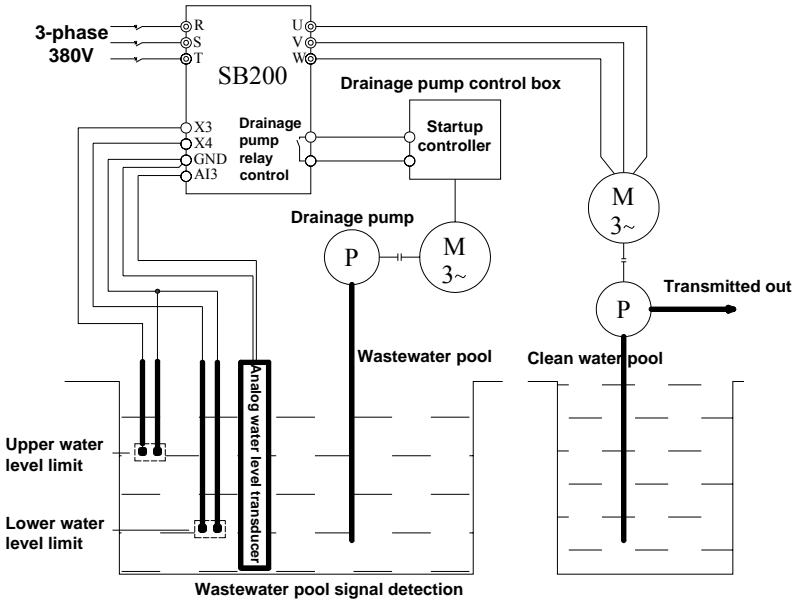

F8-10	Increasing Pump Time Delay	Factory Settings	30.0s	Modification	○
F8-11	Decreasin Pump Time Delay	Factory Settings	30.0s	Modification	○
Setting Range	0.0~600.0s				



**Increasing Pump Time Delay:** This parameter is the think time used to judge if there is need for more pumps after the output frequency of the inverter reaches the upper frequency limit. This parameter will become ineffective after firefighting operation commands are inputted. At this point, the main pumps and the auxiliary pumps may be started in the shortest time.

**Decreasing Pump time delay:** This parameter is used to judge if there is need for fewer pumps after the output frequency of the inverter reaches the lower frequency limit of the pump.



**NOTE:** The settings of the Increasing Pump Time Delay and Decreasing Pump time delay depend on the rate of pressure change. The settings must be the shortest without oscillation.

F8-12	Increasing Pump Coming Frequency	Factory Settings	40.00 Hz	Modification	○
F8-13	Decreasing Pump Coming Frequency	Factory Settings	45.00 Hz	Modification	○



Setting Range	0.00~50.00Hz
---------------	--------------

-  **Increasing Pump Coming Frequency:** If more pumps are needed after the output frequency reaches the upper frequency limit, the inverter will operate at the Increasing Pump Coming Frequency. This is intended to prevent a sudden pressure rise as a result of more pumps from causing pressure overshoot and oscillation.
-  **Decreasing Pump Coming Frequency:** If fewer pumps are needed after the output frequency reaches the lowest working frequency required for variable frequency operation, the inverter will operate at the Decreasing Pump Coming Frequency. This is intended to prevent a sudden decrease of pumps from causing a substantial pressure drop at a line frequency.

<b>F8-14</b>	Increasing Pump Deviation Upper Limit Settings	Factory Settings	0.20	Moderation	○
<b>F8-15</b>	Decreasing Pump Deviation Lower Limit Settings	Factory Settings	-0.20	Moderation	○
Setting Range	-F7-03~F7-03				

-  **Increasing Pump deviation upper limit settings:** If the pressure is still higher than the pressure settings (+F8-14) after the output frequency reaches the min. working frequency required for variable frequency operation, a Decreasing Pump judgment and Decreasing Pump operation will be started.
-  **Increasing Pump Deviation lower limit settings:** If the pressure is still lower than the pressure settings -F8-15 after the output frequency reaches the upper frequency limit, a Increasing Pump judgment and Increasing Pump operation will be started.

<b>F8-16</b>	<b>Mechanical Interlock Time</b>	Factory Settings	0.50s	Modification	○
Setting Range	0.05~20.00s				

-  **Mechanical Interlock Time:** This parameter is primarily used to switch a pump (motor) from variable frequency operation to line frequency operation. This is a parameter configured to prevent a short-circuit (caused by a solenoid switch (contactor) action time delay) between the inverter and the line frequency AC power supply.-
-  The larger capacity a solenoid switch (contactor) has, the longer the set time is.

<b>F8-17</b>	<b>Auxiliary Starter Startup Time</b>	Factory Settings	5.00s	Modification	○
--------------	---------------------------------------	------------------	-------	--------------	---

Setting Range	0.50~60.00s
---------------	-------------

 **Auxiliary Starter Startup Time:** Auxiliary starters are normally soft starters. In the case of a larger power auxiliary pump, soft starters are normally used for startup in order to prevent large impact currents caused by direct startup.

<b>F8-18</b>	Periodic Rotation Time	Factory Settings	360.0h	Modification	○
Setting Range	0.0~1000.0h (0.0 is ineffective)				

 **Periodic Rotation Time:** Periodic rotation units can be used to prevent longtime disuse from causing rusts of standby pumps. They are effective in improving the utilization ratio and reduce maintenance cost. This is the longest shutdown time of the pump. If the standby pump is disused for a time longer than the periodic rotation time, the standby pump will be started for operation.

<b>F8-19</b>	<b>Lower Frequency Limit Operation Shutdown Time</b>	Factory Settings	300.0s	Modification	○
Setting Range	0.0~1200.0s (0.0 is ineffective)				

 **Lower Frequency Limit Operation Shutdown Time:** If more than one pump is in line frequency operation, one pump is in variable frequency operation and the variable-frequency pump operates at the lower frequency limit for a long time, one pump working at line frequency will be shut down if this status exceeds the preset time. If the parameter is set as 0, this function will be ineffective. If the parameter settings are too small, oscillation may occur.

<b>F8-20</b>	<b>Sleeping Frequency</b>	Factory Settings	40.00Hz	Modification	○
Setting Range	1.00~50.00Hz				
<b>F8-21</b>	<b>Sleeping Latency Time</b>	Factory Settings	60.0s	Modification	○
Setting Range	1.0~1800.0s				
<b>F8-22</b>	<b>Wakeup Deviation Settings</b>	Factory Settings	-0.20	Modification	○
Setting Range	-F7-03~F7-03				
<b>F8-23</b>	<b>Wakeup Time Delay</b>	Factory Settings	30.0s	Modification	○
Setting Range	0.1~300.0s				

 **The sleeping function requires sleeping mode settings.** If water consumption is small and only one pump is in variable frequency operation, the system will switch to the sleeping mode and the main pump will shut down when the working frequency is lower than the sleeping frequency ((F8-20) and the operation time exceeds the sleeping latency time (F8-21). If the small sleeping pump is used, the small sleeping pump will be started. ① If the working frequency is the upper frequency limit or the line frequency and the pressure persists at a value lower than the wakeup pressure (setting: +F8-22), the system will be restored to normal water supply when the working time exceeds the wakeup time delay (F8-23); ② If the pressure persists at a value above the upper limit of switching pressure (setting: +F8-14), the small pump will operate as determined by the PID lower limit options (F8-02) (see Page 72); if there is no small sleeping pump and the water consumption increases, the system will be restored to normal water supply when the pressure drops below the wakeup pressure (setting: +F8-22) and persists for a time longer than the wakeup time delay.

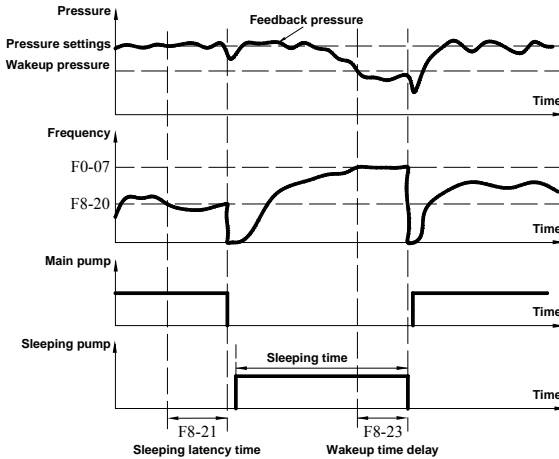

F8-24	Min. Working Frequency of Pump #1	Factory Settings	20.00 Hz	Modification	○
F8-25	Min. Working Frequency of Pump #2	Factory Settings	20.00 Hz	Modification	○
F8-26	Min. Working Frequency of Pump #3	Factory Settings	20.00 Hz	Modification	○
F8-27	Min. Working Frequency of Pump #4	Factory Settings	20.00 Hz	Modification	○

<b>F8-28</b>	<b>Min. Working Frequency of Pump #4</b>	Factory Settings	20.00 Hz	Modification	○
<b>F8-29</b>	<b>Min. Working Frequency of Small Sleeping Pump</b>	Factory Settings	20.00 Hz	Modification	○
Setting Range	1.00~F0-07 “Upper frequency limit”				

 **Min. Working Frequency of Pumps.** The min. working frequency of Pumps F8-24~29 is the lower frequency limit of the corresponding pumps working at a variable frequency. The lower frequency limit of different pumps is set differently in order to rationalize system operation.

<b>F8-30</b>	<b>Rated Current of Pump #1</b>	Factory Settings	Depend on inverter model No.	Modification	×
<b>F8-31</b>	<b>Rated Current of Pump #2</b>	Factory Settings	Depend on inverter model No.	Modification	×
<b>F8-32</b>	<b>Rated Current of Pump #3</b>	Factory Settings	Depend on inverter model No.	Modification	×
<b>F8-33</b>	<b>Rated Current of Pump #4</b>	Factory Settings	Depend on inverter model No.	Modification	×
<b>F8-34</b>	<b>Rated Current of Pump #5</b>	Factory Settings	Depend on inverter model No.	Modification	×
<b>F8-35</b>	<b>Rated Current of Small Sleeping Pump</b>	Factory Settings	Depend on inverter model No.	Modification	×
Setting Range	0.5~1200.0A				

 **Rated Current of Pumps:** The rated current of pumps F8-30~35 should be set according to parameters on the nameplates. This is used for an overload alarm. The function checks the overload protection of pumps working at a variable frequency.

<b>F8-36</b>	<b>Trial Working frequency</b>	Factory Settings	25.00 Hz	Modification	○
Setting Range	1.00~F0-07“Upper Limit Frequency”				
<b>F8-37</b>	<b>Pump Trial Operation</b>	Factory Settings	000	Modification	×
Setting Range	111 Sleeping pump in trial operation 222 Drainage pump in trial operation 331~335 Pumps #1~#5 in trial operation at a variable frequency 441~445 Pumps #1~#5 in trial operation at a line frequency				
<b>F8-38</b>	<b>Pump Trial Operation Timekeeping</b>	Factory Settings	20.0s	Modification	○
Setting Range	0.5~3000.0s				

 **Pump Trial Operation:** This parameter is used for system debugging and is effective only when F8--00≠0 and the pump is shut down. Set Parameter F8-37, enter the command and you will enter the testing status. If the variable-frequency circulator pump is subject to line frequency trial operation, the pump will be directly switched to line frequency. For a variable-frequency circulator pump, variable frequency/line frequency trial operation can be conducted to confirm if the rotation direction is uniform. If a line frequency operation is required, you must confirm that the rotation directions of line-frequency operation and variable-frequency operation are uniform.

<b>F8-39</b>	<b>Pump Startup/Shutdown Sequence</b>	Factory Settings	10	Modification	×
Setting Range	Units digit: Shutdown sequence (applicable only to auxiliary pumps) 0: First to be started and first to be shut down 1: First to be started and last to be shut down				
	Tens digit: Startup sequence (Circulator Pumps 0~5 startup/shutdown options) 0: Pumps to be first started will be selected via the control terminal 1: Pump #1 is the first to be started 2: Pump #2 is the first to be started 3: Pump #3 is the first to be started 4: Pump #4 is the first to be started 5: Pump #5 is the first to be started 6: Pumps involving a relatively long startup/shutdown time				

 **Shutdown Sequence:** The shutdown sequence applies to auxiliary pumps only. The startup before shutdown mode applies primarily to pumps with different capacity.

 **Startup Sequence:** If “0” is selected, the control terminal will select the first pump to be started. Settings of external terminals include 55 “Priority Pump Startup Option 1”, 56 “Priority Pump Startup Option 2” and 57 “Priority Pump Startup Option 3”. See the description of terminal functions on Page 55.



F8-44	Pump #1 Disabled	Factory Settings	0	Modification	○
F8-45	Pump #2 Disabled	Factory Settings	0	Modification	○
F8-46	Pump #3 Disabled	Factory Settings	0	Modification	○
F8-47	Pump #4 Disabled	Factory Settings	0	Modification	○
F8-48	Pump #5 Disabled	Factory Settings	0	Modification	○
F8-49	Small Sleeping Pump Disabled	Factory Settings	0	Modification	○
F8-50	Drainage Pump Disabled	Factory Settings	0	Modification	○
Setting Range	0: Ineffective		11: Pump operation disabled		

 **Pump Operation Disabled:** When the parameters (F8-44~50) of the water supply system are 11, the corresponding pumps will be disabled to facilitate overhaul and maintenance. This parameter group will be effective as are Digital Inputs 43~49.

F8-51	Standby Pump Number Settings	Factory Settings	00	Modification	×
Setting Range	Units digit: Number of standby pumps to be started up/shut down in a cyclic mode: 0~2 Tens digit: Number of Auxiliary Standby Pumps: 0~2				

 When the standby pump number settings exceed or are equal to system settings, the standby pump settings will be ineffective.

**6.10. F9: Time Management (Applicable to LCD Control Panel Only)**

F9-00	Time Settings at Point T1	Factory Settings	0.00	Modification	○
F9-01	Time Settings at Point T2	Factory Settings	3.00	Modification	○
F9-02	Time Settings at Point T3	Factory Settings	6.00	Modification	○
F9-03	Time Settings at Point T4	Factory Settings	9.00	Modification	○
F9-04	Time Settings at Point T5	Factory Settings	12.00	Modification	○
F9-05	Time Settings at Point T6	Factory Settings	15.00	Modification	○

<b>F9-06</b>	<b>Time Settings at Point T7</b>	Factory Settings	18.00	Modification	○
<b>F9-07</b>	<b>Time Settings at Point T8</b>	Factory Settings	21.00	Modification	○
Setting Range	Hour: 0~23; minute: 0~59 (T1 ≤ T2 ≤ T3 ≤ T4 ≤ T5 ≤ T6 ≤ T7 ≤ T8)				
<b>F9-08</b>	Action Options at Point T1	Factory Settings	0	Modification	×
<b>F9-09</b>	Action Options at Point T2	Factory Settings	0	Modification	×
<b>F9-10</b>	Action Options at Point T3	Factory Settings	0	Modification	×
<b>F9-11</b>	Action Options at Point T4	Factory Settings	0	Modification	×
<b>F9-12</b>	Action Options at Point T5	Factory Settings	0	Modification	×
<b>F9-13</b>	Action Options at Point T6	Factory Settings	0	Modification	×
<b>F9-14</b>	Action Options at Point T7	Factory Settings	0	Modification	×
<b>F9-15</b>	Action Options at Point T8	Factory Settings	0	Modification	×
Setting Range	0: No action                      ±1: Control of Y1 digital output                      ±2: Control for Y2 digital output ±3: Output Control for Relay T1                      ±4: Output control for Relay T2                      ±5: Output Control for Relay T3 ±6: Output Control for Relay T4                      ±7: Output Control for Relay T5                      ±8: Virtual Digital Input 1 ±9: Virtual Digital Input 2                      ±10: Virtual Digital Input 3                      ±11: Virtual Digital Input 4				
<b>F9-16</b>	<b>Functions of Virtual Digital Input 1</b>	Factory Settings	0	Modification	×
<b>F9-17</b>	<b>Functions of Virtual Digital Input 2</b>	Factory Settings	0	Modification	×
<b>F9-18</b>	<b>Functions of Virtual Digital Input 3</b>	Factory Settings	0	Modification	×
<b>F9-19</b>	<b>Functions of Virtual Digital Input 4</b>	Factory Settings	0	Modification	×
Setting Range	The same definition as Input Terminal X; refer to the table of definitions of digital input on Page 51				

 **Time Management:** The LCD control panel of the SB200 series has an inbuilt time module capable of configuration for 8 time slots. The configuration of time must ensure that  $T1 \leq T2 \leq T3 \leq T4 \leq T5 \leq T6 \leq T7 \leq T8$ . When setting actions for each point in time, functions required to be outputted at a designated time may be assigned (In the case of a digital output or relay output, the digital output of the corresponding functions must be set as 18; see Page 58). In the case of a

digital output terminal, a positive value means Output Transistor Y is connected and Output Transistor Y is disconnected. In the case of a relay output, a positive value means the relay is closed and a negative value means the relay is open. In the case of a virtual digital output: a positive value means the selection of a function and a negative value means the cancellation of a function.

**Examples: Refer to the following figures:**

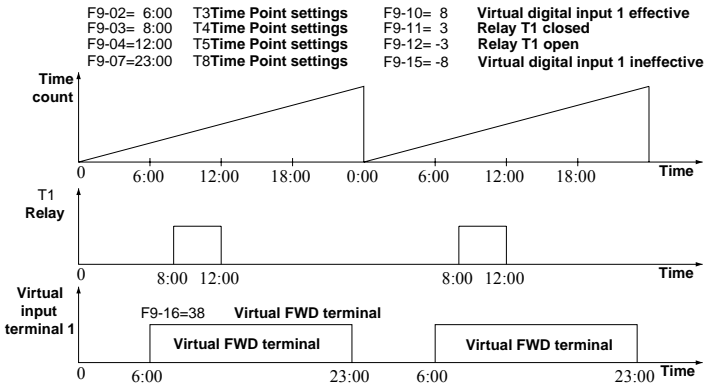

**6.11 Fb: Protection Functions and Advanced Inverter Settings**

<b>Fb-00</b>	<b>Motor Heat Dissipation Conditions</b>	Factory Settings	0	Modification	○
Setting Range	0: Conventional motor 1: Variable-frequency motor or conventional motor with a separate fan				
<b>Fb-01</b>	<b>Motor Overload Protection Value</b>	Factory Settings	100.0%	Modification	○
Setting Range	50.0~150.0%; the rated motor current is taken as 100%				
<b>Fb-02</b>	<b>Motor Overload Protection Action Options</b>	Factory Settings	2	Modification	×
Setting Range	0: No action      1:Alarm and continue operation      2: Fault and free shutdown				

Fb-00 “Motor heat dissipation conditions”: Motor heat dissipation depends on the motor type used in combination with the inverter. The heat dissipation performance of the self-cooling fan of a conventional motor deteriorates when the motor is working at a low speed; also, the overload protection value of the inverter also drops at a low speed. See the following figure:

Fb-01 “Motor overload protection value”: This parameter is used to adjust the overload protection curve of the motor. If Fb-01 is set as 100% for a motor working at a rated rotation speed and the parameter suddenly switches to 150% of the rated motor current, overload protection will be actuated in 1 minute. Refer to the following curves for overload protection time:

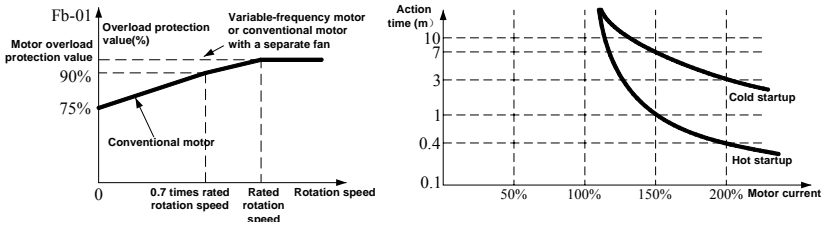

After overload protection becomes effective, the motor will not resume operation until the motor cools down over a period of time.

**CAUTION:** Motor overload protection only applies to cases where one motor is driven by one inverter. In cases where more than one motor is driven by the same inverter, heat protection must be provided for each motor.

<b>Fb-03</b>	<b>Motor Overload Protection Options</b>	Factory Settings	00	Modification	×
Setting Range	Units digit: overload detection options 0: Always on      1: During only constant-speed operation Tens digit: Overload action options: 0: No action    1: Alarm and continue operation    2: Alarm and free shutdown				
<b>Fb-04</b>	<b>Motor Overload Detection Level</b>	Factory Settings	130.0%	Modification	×
Setting Range	20.0~200.0%; the rated motor current is taken as 100%				
<b>Fb-05</b>	<b>Motor Overload Detection Time</b>	Factory Settings	5.0s	Modification	×
Setting Range	0.0~30.0s				

Motor Overload: When the motor current exceeds Fb-04 and is maintained in excess of the time settings of Fb-05, a response will be made according to the action mode set by Fb-03. This function may be used to check if any abnormal mechanical load causes an overcurrent.

<b>Fb-06</b>	<b>Motor Underload Protection</b>	Factory Settings	0	Modification	×
Setting Range	0: No action    1: Alarm and continue operation    2: Fault and free shutdown				
<b>Fb-07</b>	<b>Motor Underload Protection Level</b>	Factory Settings	30.0%	Modification	×
Setting Range	0.0~100.0%; the rated motor current is taken as 100%				

<b>Fb-08</b>	<b>Underload Protection Detection Time</b>	Factory Settings	1.0s	Modification	×
Setting Range	0.0~100.0s				

 Motor Underload Protection: When the output current is lower than Fb-07 and is maintained for a time longer than the time settings of Fb-08, a response will be made according to the action mode set by Fb-06. This function can promptly detect such faults as no-load pump idle operation, broken driving belts and motor-side contactor open-circuit.

 This protection function must be disabled when the inverter is under a no-load test.

<b>Fb-09</b>	<b>Analog Input Offline Action</b>	Factory Settings	0	Modification	×
Setting Range	0: No action 1: “AL.ACo” alarm signal is emitted; operation at the average frequency during the 10s before offline 2: “AL.ACo” alarm signal is emitted; operation at the “analog input offline forced frequency” 3: Er.ACo error signal is emitted, followed by a free shutdown				
<b>Fb-10</b>	<b>Analog Input Offline Forced Frequency</b>	Factory Settings	0.00Hz	Modification	○
Setting Range	0.00Hz~F0-06 “Max. frequency”				

 Analog Input Offline Protection: When the inverter detects an analog input signal lower than the corresponding offline threshold value, an offline is confirmed.

 Related Parameters: F6-07 “AI1Offline Threshold”, F6-16“AI2 Offline Threshold” and F6-23“AI3 Offline Threshold”.

<b>Fb-11</b>	<b>Other Protection Action Options</b>	Factory Settings	0022	Modification	×
Setting Range	Units digit: Inverter input phase lack protection 0: No action 1: Alarm and continue operation 2: Fault and free shutdown				
	Tens digit: Inverter output phase lack protection 0: No action 1: Alarm and continue operation 2: Fault and free shutdown				
	Hundreds digit: Control panel offline protection 0: No action 1: Alarm and continue operation 2: Fault and free shutdown				
	Thousands digit: Parameter storage failure action options 0: Alarm and continue operation 1: Fault and free shutdown				

 The input phase lack protection function of a inverter makes judgments according to the ripples of DC busbar voltage induced by an input phase lack. An input phase lack may not be detected in the case of a no-load or light-load inverter. An input phase lack will be detected if a serious input three-phase unbalance or output oscillation occurs.

- 📖 Inverter Output Phase lack Protection: In the case of a inverter output phase lack, the motor will switch to single-phase operation and the current, torque and pulse will increase. Output phase lack protection can prevent damages to motors and mechanical loads.
- 📖 Output phase lack protection is ineffective in cases where the output frequency or current is very low.

<b>Fb-12</b>	<b>Acceleration Overcurrent Stall Prevention Options</b>	Factory Settings	1	Modification	×
Setting Range	0: Ineffective 1: Effective; abnormal shutdown will be reported in the event of a stall timeout (Er.Abb) 2: Effective; no time limit is set for stall				
<b>Fb-13</b>	<b>Acceleration Overcurrent Stall Point</b>	Factory Settings	110.0 %	Modification	×
Setting Range	10.0~130.0%; the rated inverter current is taken as 100%				
<b>Fb-14</b>	<b>Constant Speed Overcurrent Stall Prevention Options</b>	Factory Settings	1	Modification	×
Setting Range	0: Invalid 1: Effective; abnormal shutdown will be reported in the event of a stall timeout (Er.Abb) 2: Effective; no time limit is set for stall				
<b>Fb-15</b>	<b>Constant Speed Overcurrent Stall Point</b>	Factory Settings	110.0 %	Modification	×
Setting Range	10.0~110.0%; the rated inverter current is taken as 100%				
<b>Fb-16</b>	<b>Overvoltage Stall Prevention Options</b>	Factory Settings	1	Modification	×
Setting Range	0: Ineffective 1: Valid				
<b>Fb-17</b>	<b>Overvoltage Stall Point</b>	Factory Settings	700V	Modification	×
Setting Range	650~750V				

- 📖 In the acceleration process, when Fb-12 “Acceleration Overcurrent Stall Prevention Options” is effective and the output current is greater than Fb-13 “Acceleration Overcurrent Stall Point”, the acceleration will be suspended until the current drops to normal. After that, the acceleration process resumes. Refer to the following figure (a):
- 📖 In the constant operation process, when Fb-14 “Constant Overcurrent Stall Prevention Options” is effective and the output current exceeds Fb-15 “Constant Speed Overcurrent Stall Point”, the motor will decelerate until the current drops to normal. After that the motor accelerates again to resume the original working frequency. See the following figure (b):

📖 In the deceleration process, when Fb-16 “Overvoltage Stall Prevention Options” is effective and the DC busbar voltage exceeds Fb-17 “Overvoltage Stall Point”, the deceleration will be suspended until the DC busbar voltage drops to normal. After that, the deceleration process resumes. Refer to the following figure (c):

📖 When selecting the stall timeout limit, if the motor is in constant stall status, an abnormal shutdown fault will be reported (Er.Abb).

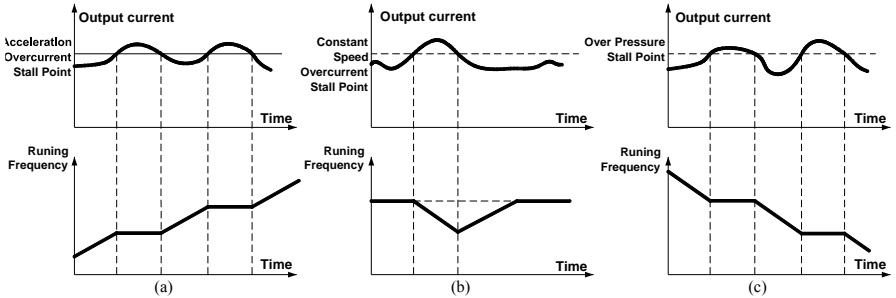

<b>Fb-18</b>	<b>DC Busbar Undervoltage Action</b>	Factory Settings	0	Modification	×
Setting Range	0: Free shutdown; an undervoltage fault is reported (Er.dcL) 1: Free shutdown; within the “Instantaneous Power Failure Time Allowance” (Fb-20), the inverter will restart if the power supply is restored and an undervoltage fault will be reported (Er.dcL) if the power supply is not restored. 2: Free shutdown; while the CPU is in operation, the inverter will restart if the power supply is restored. No undervoltage fault will be reported 3: Decelerated operation; if the power supply is restored while the CPU is in operation, the frequency will be accelerated till the frequency settings. No undervoltage fault will be reported.				
<b>Fb-19</b>	<b>DC Busbar Undervoltage Point</b>	Factory Settings	380V	Modification	×
Setting Range	300~450V				
<b>Fb-20</b>	<b>Instantaneous Power Failure Time Allowance</b>	Factory Settings	0.1s	Modification	×
Setting Range	0.0~30.0s				
<b>Fb-21</b>	<b>Instantaneous Power Failure Deceleration Time</b>	Factory Settings	0.0s	Modification	×
Setting Range	0.0~200.0s; if the parameter is set as 0.0, the present deceleration time is adopted				

📖 The detection of instantaneous power failure is finished by DC busbar voltage detection. When the DC busbar voltage is lower than Fb-19 “DC busbar undervoltage point”, the following

solutions may be adopted:

**Fb-18=0:** In this case, an undervoltage is considered as a fault and a free shutdown will follow and a DC busbar undervoltage fault will be reported;

**Fb-18=1:** In this case, the output will be locked and the drop in DC bus voltage slows down. If the voltage is restored within “Instantaneous Power Failure Time Allowance” (Fb-20), a restart (depending on “Restart Mode of Instantaneous Power Failure, Self-Reset and Operation Suspension”) will follow and the undervoltage timeout fault will be reported.

**Fb-18=2:** The output is locked and the drop in DC busbar voltage slows down. As long as the undervoltage does not cause a power failure (judged by control panel display), a restart will follow after detection of voltage restoration (The startup mode depends on Fb-25 “Restart Mode of Instantaneous Power Failure, Self-Reset and Operation Suspension”);





**Fb-18=3:** In the case of an undervoltage, press Fb-21 “Instantaneous Deceleration Time” or maintain the decelerated operation at the present deceleratin time. The DC busbar voltage is maintained by the kinetic energy feedback of the load in deceleration. If the voltage is restored, the motor will accelerate to the frequency settings. The maintenance time of DC busbar voltage is related to load inertia, rotation speed, torque and deceleration time.

 **Fb-18=1, 2 or 3: This solution is intended for large-inertia loads, such as fans and centrifuges to prevent undervoltage shutdown caused by instantaneous power failure.**

 Fb-20 “Instantaneous Power Failure Time Allowance”: The parameter only applies to cases where Fb-18=1.

 A free shutdown will follow and an undervoltage fault (Er.dcl) will be reported in the case of an undervoltage in operation. In the case of an undervoltage in standby mode, only an alarm will be sounded (AL.dcl).

<b>Fb-22</b>	<b>Fault Self-Reset Frequency</b>	Factory Settings	0	Modification	×
Setting Range	0~10				
<b>Fb-23</b>	<b>Self-Reset Interval</b>	Factory Settings	5.0s	Modification	×
Setting Range	1.0~30.0s				
<b>Fb-24</b>	<b>Fault Output during Self-Reset</b>	Factory Settings	0	Modification	×
Setting Range	0: Output applicable 1: Output inapplicable				
<b>Fb-25</b>	<b>Restart Mode of Instantaneous Power Failure, Self-Reset and Operation Suspension</b>	Factory Settings	1	Modification	×
Setting Range	0: Startup in the startup mode 1: Tracking startup				

-  **Fault Self-Reset:** Faults in operation will be self-reset according to Fb-23 “Self-Reset Interval” and Fb-22 “Fault Self-Reset Frequency”. Restarts will also be possible. This function is intended to prevent trips caused by misoperation, instantaneous overvoltage of the power supply or external non-repetitive impacts.
-  **Self-Reset:** Faults in operation will be self-reset after the self-reset interval. If the fault is corrected, press Fb-25 “Restart Mode of Instantaneous Power Failure, Self-Reset and Operation Suspension” for a restart. If the fault persists and the reset frequency has not exceeded Fb-22, self-reset trials will continue; otherwise, a fault will be reported and the system will shut down.
-  **Zero Clearing Conditions of Fault Reset Frequency:** After the inverter has a fault self-reset, no fault will follow in 10 minutes on end. If the fault is detected, manual reset will be needed. The power supply will be resumed after power failure.
-  Fb-24 “Fault Output during Self-Reset”: During the self-reset, Digital Output 6 “Fault Output” can be tested if it is effective.
-  Power device protection (Er.FoP) and external faults (Er.EEF) will not require a self-reset.





**CAUTION: Self reset must be used with care; otherwise personal injuries or property losses may occur.**

<b>Fb-26</b>	<b>Poweron Self-Restart Enabled</b>	Factory Settings	1	Modification	○
Setting Range	0: Disabled 1: Enabled				

-  In the case of a terminal execution command channel where a level-type working mode is selected (F4-13=0, 1 or 2), if the execution command becomes effective upon power supply. You may choose if the parameter selection will cause a prompt startup upon power supply.

<b>Fb-27</b>	<b>Braking Unit Working Point</b>	Factory Settings	680V	Modification	○
Setting Range	620~720V				

-  The braking resistor of a braking unit will consume energy to realize a quick shutdown. If the DC busbar voltage exceeds the braking unit working point, the braking unit will automatically start up.
-  This parameter only applies to inverter types with inbuilt braking units.

<b>Fb-28</b>	<b>Modulation Mode</b>	Factory Settings	0	Modification	○
--------------	------------------------	------------------	---	--------------	---



Setting Range	0: Disabled	1: Enabled
---------------	-------------	------------

Deadband compensation can reduce output harmonics and torque pulse. But deadband compensation must be disabled when the inverter is used for a power supply.

<b>Fb-33</b>	Space Vector Angle Shutdown Memory	Factory Settings	0	Modification	×
Setting Range	0: Memory inapplicable		1: Memory applicable		

Used to maintain synchronism of a synchronous motor restarted after a shutdown; it is effective only for V/F control.

<b>Fb-34</b>	Overmodulation Enablement	Factory Settings	1	Modification	×
Setting Range	0: Disabled		1: Enabled		

Overmodulation Enablement: If overmodulation enablement is enabled, the inverter will have a relatively high output voltage that approaches or exceeds the supply voltage. But overmodulation will cause a relatively great torque pulse of the motor. If overmodulation enablement is disabled, torque pulse caused by overmodulation can be prevented and control properties of such loads as grinding machines can be improved.

<b>Fb-35</b>	Cooling Fan Control	Factory Settings	0	Modification	○
Setting Range	0: Auto operation		1: Constant operation		

Auto operation: The cooling fan operates automatically according to the internal temperature of the inverter.

<b>Fb-36</b>	Avoidance Frequency 1	Factory Settings	0.00Hz	Modification	○
Setting Range	0.00~625.00Hz				
<b>Fb-37</b>	Width of Avoidance Frequency 1	Factory Settings	0.00Hz	Modification	○
Modification	0.00~20.00Hz				
<b>Fb-38</b>	Avoidance Frequency 2	Factory Settings	0.00Hz	Modification	○
Modification	0.00~625.00Hz				
<b>Fb-39</b>	Width of Avoidance Frequency 2	Factory Settings	0.00Hz	Modification	○
Modification	0.00~20.00Hz				

<b>Fb-40</b>	<b>Avoidance Frequency 3</b>	Factory Settings	0.00Hz	Modification	○
Modification	0.00~625.00Hz				
<b>Fb-41</b>	<b>Width of Avoidance Frequency 3</b>	Factory Settings	0.00Hz	Modification	○
Modification	0.00~20.00Hz				

- 📖 The avoidance frequency function is intended to protect the working frequency of the inverter from mechanic resonance points.
- 📖 In the acceleration/deceleration process, the running frequency passing through the avoidance frequency normally, limit inverter not be running steadily in the range of avoidance frequency width only.

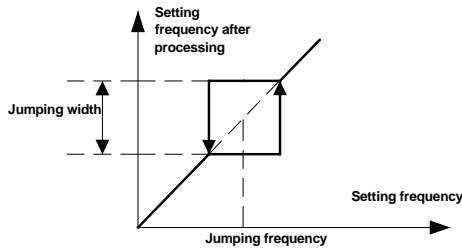

<b>Fb-42</b>	<b>Water Level Abnormality Options</b>	<b>Transducer</b>	Factory Settings	0	Modification	○
Setting Range	0: No action	1: Alarm	2: Fault and free shutdown			

- 📖 When the transducer is used for constant pressure water supply and a clean water pool level detector is installed, if the water level detector has an abnormality, a corresponding action will follow (alarm or fault shutdown). Abnormal cases include a connected upper level limit detector along with a disconnected lower level limit detector.
- 📖 AL.LPo alarm signal is emitted and the present status is maintained.
- 📖 Er.LPo alarm signal is emitted and a free shutdown will follow.









**6.12 FC: Keyboard Operation and Display Settings**





<b>FC-00</b>	<b>Display Parameter Options</b>	Factory Settings	0	Modification	○
Setting Range	0: All menus are displayed 1: Only parameters selected by the user are displayed 2: Only parameters different from factory settings are displayed				

- 📖 FC-00=1: Only FC-16~FC-47 “User Parameters 1~32” are displayed. Although a user

password is ineffective for these parameters, the modification of FC-00 requires the user password.

 FC-00=2: In order to facilitate debugging and maintenance, only parameters different from factory settings are displayed.

FC-01	Keyboard Functions and Auto Lock	Factory Settings	0000	Modification	×
Setting Range	Units digit: Auto key lock 0: Unlocked                      1: All locked                      2: All locked except  3: All locked except  4: All locked except  and  5: All locked except  and  Tens digit: Function options for  0: Effective only when the command execution channel is the control panel 1: Effective when the command execution channel is the control panel, terminal or communication port; the system is shut down in the shutdown mode				
	2: When the control panel is the command execution channel, the system can be shut down in the shutdown mode If a free shutdown is executed when the command execution channel is not the control panel, Er.Abb will be reported				
	Hundreds digit: Function options for  (applicable only to panel command channels) 0: Invalid                      1: Valid only in standby mode 2: Valid in both standby mode and operation mode				
	Thousands digit: Function options for  (applicable only to panel command channels) 0: Operation function options                      1: Jogging options				

 Auto Key Lock: If no key is pressed within 1 minute, the keys will be locked automatically; in the monitor mode, press  +  and the keys will be automatically locked; to unlock the keys, hold  +  for 3 seconds.

FC-02	Monitoring Parameter Option 1	Factory Settings	1	Modification	○
FC-03	Monitoring Parameter Option 2	Factory Settings	-1	Modification	○
FC-04	Monitoring Parameter Option 3	Factory Settings	-1	Modification	○
FC-05	Monitoring Parameter Option 4	Factory Settings	-1	Modification	○
FC-06	Monitoring Parameter Option 5	Factory Settings	-1	Modification	○
FC-07	Monitoring Parameter Option 6	Factory Settings	-1	Modification	○

FC-08	Monitoring Parameter Option 7	Factory Settings	-1	Modification	○
FC-09	Operation Option 1 Monitoring Parameter	Factory Settings	0	Modification	○
FC-10	Operation Option 2 Monitoring Parameter	Factory Settings	2	Modification	○
FC-11	Operation Option 3 Monitoring Parameter	Factory Settings	4	Modification	○
FC-12	Operation Option 4 Monitoring Parameter	Factory Settings	-1	Modification	○
Setting Range	-1~50; -1 means void; 0~50 mean FU-00~FU-50				

 **Monitoring Parameter Options:** Parameters to be monitored are selected from the FU menu and displayed in both standby mode and operation mode.

 **Operation Monitoring Parameter Options:** Parameters to be monitored are selected from the FU menu and displayed only in operation mode.

FC-13	Rotation Display Coefficient	Factory Settings	1.000	Modification	○
Setting Range	0.001~10.000 FU-05 “Actual Rotation Speed”= $120 \times \text{Working Frequency} \div \text{Number of Motor Poles} \times \text{FC-13 “Rotation Speed Display Coefficient”}$ FU-06 “Set Rotation Speed”= $120 \times \text{Frequency Settings} \div \text{Number of Motor Poles} \times \text{FC-13 “Rotation Speed Display Coefficient”}$				

 This function is only used for conversion of rotation speed and does not affect the actual rotation speed and motor control.

FC-14	Linear Velocity Display Coefficient	Factory Settings	0.01	Modification	○
Setting Range	0.01~100.00 FU-09 “Actual Linear Velocity”= $\text{Working Frequency} \times \text{FC-14 “Linear Velocity Display Coefficient”}$ FU-10 “Set Linear Velocity” = $\text{Frequency Settings} \times \text{FC-14 “Linear Velocity Display Coefficient”}$				

 This is only used for conversion of linear velocity and does not affect the actual linear velocity and motor control.





FC-15	Units of PID Settings and Feedback Values	Factory Settings	14	Modification	○
Setting Range	0: Hz    1: A    2: V    3: %    4: kW    5: s    6: rpm    7: mps    8: m 9: mA    10: mV    11: Pa    12: kPa    13: °C    14: kg/cm <sup>2</sup> 15: mmH <sub>2</sub> O    16: MPa				

The units are effective only for the LCD panel and are used to display the units of parameters.

**6.13 FF: Communication Parameters**

<b>FF-00</b>	<b>Communication Protocol Options</b>	Factory Settings	0	Modification	×
Setting Range	0: Modbus protocol      1: Compatible USS commands      2: CAN bus				
<b>FF-01</b>	<b>Communication Data Format</b>	Factory Settings	0	Modification	×
Setting Range	0: 8,N,1 (1 start bit; 8 data bits; no parity check; 1 stop bit) 1: 8,E,1 (1 start bit; 8 data bits; even parity check; 1 stop bit) 2: 8,O,1 (1 start bit, 8 data bits; odd parity check; 1 stop bit) 3: 8,N,2 (1 start bit, 8 data bits; no parity check; 2 stop bits)				
<b>FF-02</b>	<b>Baud Rate Options</b>	Factory Settings	3	Modification	×
Setting Range	0: 1200bps      1: 2400bps      2: 4800bps      3: 9600bps 4: 19200bps      5: 38400bps      6: 57600bps      7: 115200bps 8: 250000bps      9: 500000bps NOTE: 0~5 are for Modbus and compatible USS command protocols; 0~9 are for CAN bus.				
<b>FF-03</b>	<b>Local IP Address</b>	Factory Settings	1	Modification	×
Setting Range	0~247 NOTE: 1~247 are for Modbus; 0~31 are for compatible USS commands; 0~127 are for CAN bus				
<b>FF-04</b>	<b>Communication Timeout Detection Time</b>	Factory Settings	10 .0 s	Modification	○
Setting Range	0.1~600.0s				
<b>FF-05</b>	<b>Local Response Delay</b>	Factory Settings	5 m s	Modification	○
Setting Range	0~1000ms				
<b>FF-06</b>	<b>Communication Timeout Action</b>	Factory Settings	0	Modification	×
Setting Range	0: No action      1: Alarm      2: Fault and free shutdown 3: Alarm; press F0-00 for operation 4: Alarm; press F0-07 for operation at an upper limit frequency 5: Alarm; press F0-08 for operation at the lower limit frequency				
<b>FF-07</b>	USS Message PZD Words	Factory Settings	2	Modification	×
Setting Range	0~4				

<b>FF-08</b>	Communication Frequency Setting Proportion	Factory Settings	1.000	Modification	○
Setting Range	0.001~30.000; the communication frequency settings multiplied by this parameter are equal to the set frequency				

-  The RS485 Modbus protocol of the SB200 inverter series comprises three layers: physical layer, data link layer and application layer. The physical layer and the data link layer adopt the RS485-based Modbus protocol. The application layer is used to control such inverter operations as operation, shutdown and parameter reading/writing.
-  The Modbus protocol is a master-slave protocol. There are two communication types for master-slave communication: 1. the master sends requests and the slave responds; 2. the master broadcasts and the slave does not respond. At any time, the bus can have only one sending device. The maser makes a poll on the slave, which can not send messages without obtaining the command from the master. If the communication is incorrect, the master can send the commands once again. If there is no response from the slave within a specified time, the master will treat the polled slave as being missing. If the slave can not execute a message, an abnormality message will be sent to the master. Direct communication is not available between the master and the slave. The data of a slave must be read by a master before they are sent to another slave.
-  The read-in of inverter parameters via communication can only modify values in the RAM. If parameters in the RAM need to be read into the EEPROM, the “EEP Read-In Command” (The Modbus address is 3209H) of the communication variable must be modified to1 via communication.
-  Inverter Parameter Addressing Mode: The 8 higher bits of a 16-bit Modbus parameter address are formed by the group number of the parameter and the 8 lower bits are formed by the in-group serial number. The address mode adopts the hexadecimal system. For example, the address of Parameter F4-17 is 0411H. For communication variables (control words and status words), the parameter group number is 50(32H). NOTE: Communication variables include accessible inverter parameters, communication-specific command variables and communication-specific status variables. The parameter group numbers corresponding with the menu codes are represented in the following table:

Menu Code	Parameter Group Number	Menu Code	Parameter Group Number	Menu Code	Parameter Group Number	Menu Code	Parameter Group Number
F0	0 (00H)	F5	5 (05H)	Fb	10 (0AH)	FU	15 (0FH)
F1	1 (01H)	F6	6 (06H)	FC	11 (0BH)	Communication Variable	50 (32H)

F2	2 (02H)	F7	7 (07H)	FF	12 (0CH)	—	—
F3	3 (03H)	F8	8 (08H)	Fn	13 (0DH)	—	—
F4	4 (04H)	F9	9 (09H)	FP	14 (0EH)	—	—

 Data Types in Communication: Data transmitted by communication are 16-bit integers. The min. unit is indicated by the place of the decimal point. For example, the min. unit of F0-00 “Digital Frequency Settings” is 0.01Hz; therefore, for the Modbus protocol, the figure 5000 transmitted by communication means 50.00Hz.

 Table of Communication-Specific Command Variables

Name	Modbus Address	Modification	Description
Primary Control Word	3200H	○	Bit 0: ON/OFF1 (rising edge operation; a shutdown will follow if the figure is 0) Bit 1: OFF2 (A free shutdown will follow if the figure is 0) Bit 2: OFF3 (An emergency shutdown will follow if the figure is 0) Bit 3: Drive lock (If the figure is 0, a drive lock will follow) Bit 4: Ramping enablement (The acceleration/deceleration will stop if the figure is 0) Bit 5: Unused Bit 6: Unused Bit 7: Fault reset (The rising edge will conduct a fault reset) Bit 8: Clockwise jogging Bit 9: Anticlockwise jogging Bit 10: Unused Bit 11: Settings inversion (If the figure is 1, the frequency settings will be inverted; if the figure is 0, there will be no frequency inversion) Bit 12: PC Digital Quantity 1 Bit 13: UP Bit 14: DOWN Bit 15: PC Digital Quantity 2
Communication Frequency Settings	3201H	○	A non-negative number (unit: 0.01Hz) times FF-08 will be used for the set frequency
PID Settings	3202H	○	Range: -100.00~100.00%
PC Analog Quantity	3203H	○	Range: -100.00~100.00%
Extension Control Word 1	3204H	○	Bit 0~Bit 15 correspond with Digital Inputs 1—16
Extension Control Word 2	3205H	○	Bit 0~Bit 15 correspond with Digital Inputs 17~32
Extension Control Word 3	3206H	○	Bit 0~Bit 15 correspond with Digital Inputs 33~48
Extension Control Word 4	3207H	○	Bit 0~Bit 5 correspond with Digital Inputs 49~54; all other bits are retained
Extension Control Word 5	3208H	○	Retained
EEPROM Read-In	3209H	○	When 1 is being read into this address, the parameters in the inverter RAM will be read into the EEPROM

Name	Modbus Address	Modification	Description
Inverter Power	320DH	△	Info about inverter power
Inverter Software Version	320EH	△	Info about inverter software version
Communication Protocol and Inverter Model	320FH	△	Info about communication protocol version No. and inverter model No.

NOTE: Digital Inputs 37 “Three-Wire Mode Shutdown Command”, 38 “Internal Virtual FWD Terminal” and 39 “Internal Virtual REV Terminal” apply only to terminal control. Modification via communication is ineffective.

📖 The bits (1~5) of Extension Control Words correspond respectively with Digital Inputs 1—54. See the following table for the relationship:

Extension Control Word 1	Extension Control Word 2	Extension Control Word 3	Extension Control Word 4	Extension Control Word 5
Bit 0~Bit 15	Bit 0~Bit 15	Bit 0~Bit 15	Bit 0~Bit 5	Bit 0~Bit 15
Digital Inputs 1~16	Digital Inputs 17~32	Digital Inputs 33~48	Digital Inputs 49~54	Retained

- 📖 Communication Address 320DH: Inverter Power  
Bit 0~Bit 15: Info about inverter power: 0~6553.5. Unit: 0.1kW. NOTE: 0.75kw should be rounded as 0.7kW.
- 📖 Communication Address 320EH: Inverter software version  
Bit 0~Bit 15: Inverter software version number
- 📖 Communication Address 320FH: Communication protocol version number and inverter model number.  
Bit 15~Bit 12: MODbus communication protocol version number  
Bit 11~Bit 8: Inverter voltage grade  
Bit 0~Bit 7: Inverter model number
- 📖 Table of Communication-Status Variables

Name	Modbus Address	Modification	Description
------	----------------	--------------	-------------

Name	Modbus Address	Modification	Description
Primary Status Word	3210H	△	Bit 0: Ready Bit 1: Ready for operation Bit 2: In operation Bit 3: Fault Bit 4: OFF2 is effective (0 means effective, or that the free shutdown command is effective) Bit 5: OFF3 is in shutdown status (0 means effective, the system is in an emergency shutdown process) Bit 6: The charging contactor has been disconnected Bit 7: Alarm Bit 8: Retained Bit 9: Retained Bit 10: Frequency Level Detection Signal 11 Bit 11: Retained Bit 12: Retained Bit 13: Retained Bit 14: In clockwise operation Bit 15: Retained
Working Frequency	3211H	△	Non-negative numbers (unit: 0.01Hz)
Retained	3212H	—	—
Retained	3213H	—	—
Frequency Settings	3214H	△	A non-negative number (unit: 0.01Hz)
Output Current	3215H	△	Unit: 0.1A
Output Torque	3216H	△	Unit: 0.1% of rated torque
Output Voltage	3217H	△	Unit: 0.1V
Busbar Voltage	3218H	△	Unit: 0.1V
Fault Code	3219H	△	Refer to the Table of Fault Description and Solution on Page 176
Alarm Word 1	321AH	△	Refer to the Table of Alarm Description and Solution on Page 181
Alarm Word 2	321BH	△	Refer to the Table of Alarm Description and Solution on Page 181
Extension Status Word 1	321CH	△	Bit 0~Bit 15 correspond with Digital Outputs 0~15
Extension Status Word 2	321DH	△	Bit 0~Bit 15 correspond with Digital Outputs 16~31
Extension Status Word 3	321EH	△	Bit 0~Bit 15 correspond with Digital Outputs 32~47
Extension Status Word 4	321FH	△	Bit 0~Bit 12 correspond with Digital Outputs 48~59
Extension Status Word 5	3220H	△	Retained

 The bits (Bit 1~Bit 5) of the extension status word correspond respectively with Digital Outputs 0~60. See the following table for the relationship:

Extension Status Word 1	Extension Status Word 2	Extension Status Word 3	Extension Status Word 4	Extension Status Word 5
Bit 0~Bit 15	Bit 0~Bit 15	Bit 0~Bit 15	Bit 0~Bit 12	Bit 0~Bit 15
Digital Outputs	Digital Outputs	Digital Outputs	Digital Outputs	Retained

0~15	16~31	32~47	48~59	
------	-------	-------	-------	--

& The SB200 inverter series support the Modbus protocol in RTU mode (Remote Terminal Unit). Supported functions include Function 3 (capable of reading multiple parameters; the largest number of words is 50), Function 16 (capable of writing multiple parameters; the largest number of words is 10), Function 22 (mask writing) and Function 8 (loop test). Functions 16 and 12 support broadcasting. RTU frames begin and end with a time interval of at least 3.5 characters (but the interval is 2ms for such baud rates as 19200bit/s and 38400bit/s). A typical RTU frame has the following format:

Slave Address (1 byte)	Modbus Function Number (1 byte)	Date (Multiple bytes)	CRC16 (2 bytes)
------------------------	---------------------------------	-----------------------	-----------------

Data Format and Sending Sequence of a Byte: 1 start bit, 8 data bits, 1 parity check bit (or no such bit) and 1 or 2 stop bits. Range of Slave Address: 1—247. If the message address is 0, it's a broadcast message. Cyclic Redundancy Check (CRC): CRC16 (lower bytes before higher bytes).

 **Function 3: Multi-reading.** The range of number of words read is 1—50. See the following example for the format of a message:

Example: Reading the Primary Status Word, Working Frequency and Arithmetic Unit 1 Output of Slave #1 (the address is the first 3 words of 3210H):

Master Request:

Slave Address	01H
Modbus Function Number	03H
Start Address (Higher byte)	32H
Start Address (Lower byte)	10H
Number of Words Read (Higher byte)	00H
Number of Words Read (Lower byte)	03H
CRC (Lower byte)	0AH
CRC (Lower byte)	B6H

Slave Response:

Slave Address	01H
Modbus Function Number	03H
Number of Bytes returned	06H
Higher Byte with 0H	44H
Lower Byte with 3210H	37H
Higher Byte with 1H	13H
Lower Byte with 3211H	88H
Higher Byte with 2H	00H
Lower Byte with 3212H	00H
CRC (Lower byte)	5FH
CRC (Higher byte)	5BH

 Write Once: 06H

Functional Code 06H is used for the settings of single functional parameters. Refer to the following example for the message format:

Example: Set the frequency of Slave #1 as 20.00Hz. Refer to the following table for the message format:

Master Request:

Slave Address	01H
Modbus Function Number	06H
Parameter (Higher byte) Address	32H
Parameter (Lower byte) Address	01H
Data (Higher byte)	07H
Data (Lower byte)	D0H
CRC (Lower byte)	D5H
CRC (Higher byte)	1EH

Slave Response:

Slave Address	01H
Modbus Function Number	10H
Parameter (Higher byte) Address	06H
Parameter (Lower byte) Address	32H
Data (Higher byte)	01H
Data (Lower byte)	07H
CRC (Lower byte)	D5H
CRC (Higher byte)	1EH

 **Function 16: Write Many:** The range of number of words written is 1—10. Refer to the following example for the message format.

Example: If Slave #1 is operated in the clockwise direction at 50.00Hz, the first two words of Address 3200 can be changed to 003FH and 1388H:

Master Request:

Slave Address	01H
Modbus Function Number	10H
Start Address (Higher byte)	32H
Start Address (Lower byte)	00H
Number of Words Written (Higher byte)	00H
Number of Words Written (Lower byte)	02H
Number of Bytes Written	04H
Higher Byte of the 1 <sup>st</sup> Number	00H
Lower Byte of the 1 <sup>st</sup> Number	3FH
Higher Byte of the 2 <sup>nd</sup> Number	13H
Lower Byte of the 2 <sup>nd</sup> Number	88H
CRC (Lower byte)	83H
CRC (Higher byte)	94H

Slave Response:

Slave Address	01H
Modbus Function Number	10H
Start Address (Higher byte)	32H
Start Address (Lower byte)	00H
Number of Words Written (Higher byte)	00H
Number of Words Written (Lower byte)	02H
CRC (Lower byte)	4FH
CRC (Higher byte)	70H

Example: Shut down Slave #1 and set it as clockwise, 50.00Hz. The first 2 words of Address 3200H will be modified to 003EH and 1388H:

Master Request:

Slave Address	01H
Modbus Function Number	10H
Start Address (Higher byte)	32H
Start Address (Lower byte)	00H
Number of Words Written (Higher byte)	00H
Number of Words Written (Lower byte)	02H
Number of Bytes Written	04H
Higher Byte of the 1 <sup>st</sup> Number	00H
Lower Byte of the 1 <sup>st</sup> Number	3EH
Higher Byte of the 2 <sup>nd</sup> Number	13H
Lower Byte of the 2 <sup>nd</sup> Number	88H
CRC (Lower byte)	D2H
CRC (Higher byte)	54H

Slave Response:

Slave Address	01H
Modbus Function Number	10H
Start Address (Higher byte)	32H
Start Address (Lower byte)	00H
Number of Words Written (Higher byte)	00H
Number of Words Written (Lower byte)	02H
CRC (Lower byte)	4FH
CRC (Higher byte)	70H

 Function 22: Mask Writing

When operating a control word, the “read-out—modify—read-in” mode is time-consuming and verbose. The mask writing function provides for the user a method to modify one or more bits of a control word. This function is only effective for control words (including primary control words and extension control words). Refer to the following description of operation:

Outcome = (operand & AndMask) | (OrMask & (~ AndMask)), that is,

When OrMask is all-zero, the outcome is the operand and AndMask. It can be used to reset one or more bits;

When OrMask is all-one, the operand bit (0) corresponding with AndMask will be modified to 1. It can be used to set one or more bits as 1;

When AndMask is all-zero, the outcome is OrMask;

When AndMask is all-one, the outcome remains unchanged;

Example: If Bit 7 (Digital Input 35; PID disabled) of Address 3205 (extended Extension Word 2) of Slave #1 is set as 1 and reset, the master will send requests and the slave will respond as follows (the slave will send the master command back in original):

Set Bit 7 of Extension Control Word 2 as 11

Slave Address	01H
Modbus Function Number	16H
Higher Byte of Operand Address	32H
Lower Byte of Operand Address	05H
Higher Byte of AndMask	FFH
Lower Byte of AndMask	7FH
Higher Byte of OrMask	FFH
Lower Byte of OrMask	FFH
CRC (Lower byte)	3EH
CRC (Higher byte)	68H

Reset Bit 7 of Extension Control Word 2

Slave Address	01H
Modbus Function Number	16H
Higher Byte of Operand Address	32H
Lower Byte of Operand Address	05H
Higher Byte of AndMask	FFH
Lower Byte of AndMask	7FH
Higher Byte of OrMask	00H
Lower Byte of OrMask	00H
CRC (Lower byte)	3FH
CRC (Higher byte)	D8H

- 📖 Function 8: Loop test; Test Function Number: 0000H. The frame must be returned in original. See the following table.
- 📖 Abnormal Response: A message of abnormal response will be returned if the slave cannot fulfill the request of the master. See the following example:

Loop test example:

Slave Address	01H
Modbus Function Number	08H
Higher Byte of Test Function Number	00H
Lower Byte of Test Function Number	00H
Higher Byte of Test Data	37H
Lower Byte of Test Data	DAH
CRC (Lower byte)	77H
CRC (Higher byte)	A0H

Abnormal response example:

Slave Address	1 byte
Response Code	1 byte (Modbus Function Number+80H)
Error Code	1 byte; see the following for the meaning: 1: Modbus function number unable to be processed 2: Irrational data address 3: Data value beyond the range 4: Operation fails (if read-only parameters are being written or parameters that cannot be modified in operation are being modified in operation)
CRC (Lower byte)	—
CRC (Higher byte)	—

📖 **USS Command Compatibility**

The SB200 series are also USS command-compatible, for it's specifically designed to be compatible with PC commands supporting the USS protocol. Upper computer software that supports the USS protocol can be used to control the operation of the SB200 inverter series, configure inverter frequency and access such operation status parameters as working frequency,

output current, output voltage and DC busbar voltage. The user may consult the manufacturer for acquisition of these data.

**6.14 FP: Fault Lists**

<b>FP-00</b>	Type of Last Fault	Min. Unit	—	Modification	△
Content Description	See the following list of faults:				
<b>FP-01</b>	Cumulative Operation Time during Last Fault	Min. Unit	1h	Modification	△
<b>FP-02</b>	Working frequency during Last Fault	Min. Unit	0.01Hz	Modification	△
<b>FP-03</b>	Frequency Settings during Last Fault	Min. Unit	0.01Hz	Modification	△
<b>FP-04</b>	Output Current during Last Fault	Min. Unit	0.1A	Modification	△
<b>FP-05</b>	Output Voltage during Last Fault	Min. Unit	0.1V	Modification	△
<b>FP-06</b>	Output Power during Last Fault	Min. Unit	0.1kW	Modification	△
<b>FP-07</b>	Busbar Voltage during Last Fault	Min. Unit	0.1V	Modification	△
<b>FP-08</b>	Inverter Bridge Temperature during Last Fault	Min. Unit	0.1°C	Modification	△
<b>FP-09</b>	Pump Status 1 during Last Fault	Min. Unit	—	Modification	△
Description	Ten thousands digit: #5 Thousands digit: #4 Hundreds digit: #3 Tens digit: #2 Units digit: #1 0: On standby 1: In variable-frequency operation 2: In line-frequency operation 3: Fault overhaul in operation				
<b>FP-10</b>	<b>Pump Status 2 during Last Fault</b>	Min. Unit	—	Modification	△
Description	Tens digit: Drainage pump Units digit: Sleeping pump		(Same as FP-09)		
<b>FP-11</b>	<b>Type of Last but One Fault</b>	Min. Unit	1	Modification	△
<b>FP-12</b>	<b>Cumulative Operation Time during Last but One Fault</b>	Min. Unit	1h	Modification	△
<b>FP-13</b>	<b>Type of Last but Two Fault</b>	Min. Unit	1	Modification	△
<b>FP-14</b>	<b>Cumulative Operation Time during Last but Two Fault</b>	Min. Unit	1h	Modification	△
<b>FP-15</b>	Type of Last but Three Fault	Min. Unit	1	Modification	△
<b>FP-16</b>	Cumulative Operation Time during Last but Three Time	Min. Unit	1h	Modification	△

<b>FP-17</b>	Type of Last but Four Fault	Min. Unit	1	Modification	△
<b>FP-18</b>	Cumulative Operation Time during Last but Four Time	Min. Unit	1h	Modification	△
<b>FP-19</b>	Single Operation Time during a Fault	Min. Unit	0.1h	Modification	△
<b>FP-20</b>	Fault List Cleared	Min. Unit	1	Modification	○
Setting Range	11: Clear the parameters in this menu and they will change automatically into 00 upon completion of the operation				

 Refer to the follow list of inverter faults

0: No fault	
1.ocb: Instantaneous startup overcurrent	22.CFE: Communication abnormality
2.ocA: Accelerated operation overcurrent	23.cf: Current detection fault
3.ocd: Decelerated operation overcurrent	24. LPo: Water level transducer abnormality
4.ocn: Constant speed operation overcurrent	25.Aco: Analog input offline
5.ouA: Accelerated operation overvoltage	26.PLL: Clean water pool water shortage
6.oud: Decelerated operation overvoltage	27.rHo: Thermal resistor open-circuit
7.oun: Constant speed operation overvoltage	28.Abb: Abnormal shutdown fault
8.ouE: Overvoltage on standby	29: Retained
	30: Retained
	31.PnL: Control panel offline
11.PLo: Output phase lack	
12.FoP: Power device protection	
13.oHI: Inverter overheat	
14.oLI: Inverter overload	
15.oLL: Motor overload	
16.EEF: External fault	
17.oLP: Motor overload	
18.ULD: Inverter underload	
19.cnF: Main loop contactor fault	
20.cno: Water supply system contactor fault	
21.EEP: Parameter storage failure	

6.15 FU: Data Monitoring

<b>FU-00</b>	<b>Working Frequency</b>	Min. Unit	0.01Hz	Modification	△
Description	Frequency x, reflecting the rotation speed of the motor				
<b>FU-01</b>	<b>Frequency Settings</b>	Min. Unit	0.01Hz	Modification	△
Description	Unit indicator lamp flashes				
<b>FU-02</b>	<b>Output Current</b>	Min. Unit	0.1A	Modification	△
<b>FU-03</b>	<b>Load Current Percentage</b>	Min. Unit	0.1%	Modification	△
Description	The rated inverter current is taken as 100%				
<b>FU-04</b>	<b>Output Voltage</b>	Min. Unit	0.1V	Modification	△
<b>FU-05</b>	<b>Rotation Speed</b>	Min. Unit	1r/min	Modification	△
Description	FU-05 = 120×Working Frequency÷Number of Motor Poles×FC-13 “Rotation Speed Display Coefficient”				
<b>FU-06</b>	<b>Rotation Speed Settings</b>	Min. Unit	1r/min	Modification	△
Description	FU-06 = 120× Frequency Settings÷Number of Motor Poles×FC-13 “Rotation Speed Display Coefficient”; Unit indicator lamp flashes				
<b>FU-07</b>	<b>DC Busbar Voltage</b>	Min. Unit	0.1V	Modification	△
<b>FU-08</b>	<b>Output Power</b>	Min. Unit	0.1kW	Modification	△
<b>FU-09</b>	<b>Working Linear Velocity</b>	Min. Unit	1m/s	Modification	△
Description	FU-09 “Working Linear Velocity” = Working Frequency×FC-14 “Linear Velocity Display Coefficient”				
<b>FU-10</b>	<b>Linear Velocity Settings</b>	Min. Unit	1m/s	Modification	△
Description	FU-10 “Linear Velocity Settings”=Frequency Settings×FC-14 “Linear Velocity Display Coefficient”; the Unit indicator lamp flashes				
<b>FU-11</b>	<b>PID Feedback Value</b>	Min. Unit	—	Modification	△
<b>FU-12</b>	<b>PID Settings</b>	Min. Unit	—	Modification	△
<b>FU-13</b>	<b>A11</b>	Min. Unit	0.1%	Modification	△
<b>FU-14</b>	<b>A12</b>	Min. Unit	0.1%	Modification	△
<b>FU-15</b>	<b>A13</b>	Min. Unit	0.1%	Modification	△
<b>FU-16</b>	<b>PFI</b>	Min. Unit	0.1%	Modification	△
<b>FU-17</b>	<b>UP/DOWN Adjustment</b>	Min. Unit	0.1%	Modification	△
<b>FU-18</b>	<b>Pump Status 1</b>	Min. Unit	1	Modification	△
Description	Ten thousands digit: Pump #5 Thousands digit: Pump #4 Hundreds digit: Pump #3 Tens digit: Pump #2 Units digit: Pump #1 0: On standby 1: In variable-frequency operation 2: In line-frequency operation 3: In fault overhaul				
<b>FU-19</b>	<b>Pump Status 2</b>	Min. Unit	1	Modification	△
Description	Tens digit: Drainage pump Units digit: Sleeping pump 0: On standby 1: In variable-frequency operation 2: In line frequency operation 3: In fault overhaul				
<b>FU-20</b>	<b>PID Output Value</b>	Min. Unit	0.1%	Modification	△
<b>FU-21</b>	<b>Radiator Temperature</b>	Min. Unit	0.1°C	Modification	△

<b>FU-22</b>	<b>Output Power Factor</b>	Min. Unit	0.01	Modification	△
<b>FU-23</b>	<b>KWH Meter Settings</b>	Min. Unit	0.1kWh	Modification	△
Description	0.0~6553.5kWh; hold ▲ and ▼ at one time to reset the parameters and the KWH timer				
<b>FU-24</b>	<b>KWH Timer</b>	Min. Unit	0.01h	Modification	△
Description	0.00~655.35h; hold ▲ and ▼ at one time to reset the parameter and the KWH timer				
<b>FU-25</b>	<b>Digital Input Terminal Status 1</b>	Min. Unit	1	Modification	△
Description	Ten thousands digit: X5    Thousands digit: X4    Hundreds digit: X3    Tens digit: X2    Units digit: X1 0: OFF    1: ON				
<b>FU-26</b>	<b>Digital Input Terminal Status 2</b>	Min. Unit	1	Modification	△
Description	Hundreds digit: REV    Tens digit: FWD    Units digit: X6 0: OFF    1: ON				
<b>FU-27</b>	<b>Digital Output Terminal Status</b>	Min. Unit	1	Modification	△
Description	Tens digit: Y2    Units digit: Y1 0: OFF    1: ON				
<b>FU-28</b>	<b>Relay Output Terminal Status</b>	Min. Unit	1	Modification	△
Description	Ten thousands digit: T5    Thousands digit: T4    Hundreds digit: T3    Tens digit: T2 Unit digit: T1 0: OFF    1: ON				
<b>FU-29</b>	<b>Extension Digital Input Terminal Status</b>	Min. Unit	1	Modification	△
Description	Ten thousands digit: X11    Thousands digit: X10    Hundreds digit: X9    Tens digit: X8    Units digit: X7 0: OFF    1: ON				
<b>FU-30</b>	<b>Extension Digital Output Terminal Status 1</b>	Min. Unit	1	Modification	△
Description	Ten thousands digit: T10 /Y7    Thousands digit: T9/Y6    Hundreds digit: T8/Y5 Tens digit: T7 /Y4 Units digit: T6/Y3    0: OFF    1: ON				
<b>FU-31</b>	<b>Extension Digital Output Terminal Status 2</b>	Min. Unit	1	Modification	△
Description	Relay T11    0: OFF    1: ON				
<b>FU-32</b>	<b>Communication Error Frequency</b>	Min. Unit	1	Modification	△
Description	0~60000				
<b>FU-33</b>	<b>Frequency Settings after Acceleration/Deceleration Ramping</b>	Min. Unit	0.01Hz	Modification	△
Description	The frequency after acceleration/deceleration ramping				
<b>FU-34</b>	<b>Output Frequency</b>	Min. Unit	0.01Hz	Modification	△
Description	Inverter output frequency (factory settings)				
<b>FU-35~FU-50</b>	<b>Retained</b>				

## 7 Solutions to Faults and Abnormalities

### 7.1 Inverter Faults and Solutions

List of Fault Description and Solutions

Fault Display (Fault Code)	Fault Type	Possible Cause	Solution
<b>Er.ocb</b> Er.ocb (1)	Instantaneous Startup Overcurrent	The interior or wiring of the motor has an inter-phase short circuit or short circuit to earth	Check the motor and wiring
		The inversion module is damaged	Seek for assistance
		The voltage is too high at the outset of the startup	Check the torque elevation settings
<b>Er.oCa</b> Er.oCa (2)	Accelerated Operation Overcurrent	The acceleration time is too short	Extend the acceleration time
		The V/F curve is inappropriate	Adjust the V/F curve or the torque elevation settings
		An operating motor is restarted	Set the motor as rotation speed tracking startup Do not restart until the motor is shut down
		The power grid has a low voltage	Check the power supply
		The inverter power is too low	Replace it with a inverter of greater ratings
<b>Er.oCd</b> Er.oCd (3)	Decelerated Operation Overcurrent	The deceleration time is too short	Extend the deceleration time
		There is a potential energy load or the inertia torque of the load is too great	Fit the inverter with an appropriate dynamic braking units
		The inverter power is too low	Select a inverter of greater power ratings
<b>Er.oCn</b> Er.oCn (4)	Constant Speed Operation Overcurrent	Load surge	Reduce the load surge
		Abnormal load	Check the load
		The power grid has a low voltage	Check the power supply
		The inverter power is too low	Select a inverter of greater power ratings
		Abnormal input voltage	Check the power supply
<b>Er.oUa</b> Er.oUa (5)	Accelerated Operation Overvoltage	An operating motor is restarted	Set the motor as rotation speed tracking startup Do not restart until the motor is shut down
		The deceleration time is too short	Extend the deceleration time

<b>Fault Display (Fault Code)</b>	<b>Fault Type</b>	<b>Possible Cause</b>	<b>Solution</b>
<b>Er.oud</b> Er.oud (6)	Decelerated Operation Overvoltage	There is a potential energy load or the inertia torque of the load is too great	Fit the inverter with an appropriate dynamic braking unit
		Abnormal input voltage	Check the power supply
<b>Er.oun</b> Er.oun (7)	Constant Speed Operation Overvoltage	The acceleration time settings are too short	Extend the acceleration time appropriately
		The inertia of the load is too great	Consider using a dynamic braking unit
		Abnormal input voltage	Check the power supply
<b>Er.ouE</b> Er.ouE (8)	Overvoltage on Standby	The DC busbar voltage detection circuit has a fault	Seek for assistance
		Abnormal input voltage or power failure in operation	Check the power supply and wiring
<b>Er.dcl</b> Er.dcl (9)	Undervoltage in Operation	Heavy load impact	Check the load
		The charging contactor is damaged	Check and replace it
		Input phase lack	Check the power supply and wiring
<b>Er.PLI</b> Er.PLI (10)	Input Phase Lack	Input terminal R, S or T has a phase lack	Check the wiring and installation
		Input 3-phase Unbalance	Check the input voltage
		Serious output oscillation	Adjust parameters to eliminate oscillation
<b>Er.PLo</b> Er.PLo (11)	Output Phase Lack	Output Terminal U, V or W has a phase lack	Check the output wiring Check the motor and cables
<b>Er.FoP</b> Er.FoP (12)	Power Device Protection	The output has an inter-phase short-circuit or an earth short-circuit	Re-wire
		The control board or plug-in comes loose	Check and re-wire
		The connection line between the motor and the inverter is too long	Fit the inverter with an output reactor or filter
		An overcurrent of the braking unit of the 22kW inverter and below	Check the resistance and connection line of the external braking resistor
		Serious interference or inverter damage	Seek for assistance
<b>Er.oHI</b> Er.oHI (13)	Inverter Overheat	Ambient temperature too high	Reduce the ambient temperature
		Obstructed air duct or damaged fan	Clean the air duct or replace the fan with a new one
		Overload	Check the load or select a large-power inverter
<b>Er.oLI</b>	Inverter	Overload	Check the load or select a large-power inverter



Fault Display (Fault Code)	Fault Type	Possible Cause	Solution
Er.oLI (14)	Overload	Inverter overtemperature	Check the fan, air duct and ambient temperature
		Acceleration time too short	Extend the acceleration time
		DC braking current too large	Reduce the DC braking current
		Inappropriate V/F curve	Adjust the V/F curve and torque elevation range
		An operating motor is restarted	Set the motor as tracking start; do not restart the motor until it is completely shut down
		Input voltage too low	Check the input voltage
<b>Er.oLL</b> Er.oLL (15)	Motor Overload	Inappropriate V/F curve	Set the V/F curve and torque elevation range correctly
		Input voltage too low	Check the input voltage
		A conventional motor operates under a heavy load at a low speed for a long time	Fit the motor with a separate cooling fan or use a variable-frequency motor
		The nameplate texts are incorrect or motor overload protection settings are inappropriate	Set F3-02, Fb-00 and Fb-01 correctly
		The motor stalls or has an abrupt load change	Check the load
<b>Er.EEF</b> Er.EEF (16)	External Fault	The external fault terminal is closed	Rectify the external fault
<b>Er.oLP</b> Er.oLP (17)	Motor Overload	The motor current exceeds the overload detection level and the overload detection time	Check the load Check the overload protection settings
<b>Er.ULd</b> Er.ULd (18)	Inverter Underload	The output current of the inverter falls below the underload protection level and the underload detection time	Check the load Check the underload protection settings
<b>Er.cnF</b> Er.cnF (19)	Main Loop Contactor Fault	Damaged contactor	Replace the main loop contactor and seek for assistance
		Damaged control loop	Seek for assistance
<b>Er.cno</b> Er.cno (20)	Water Supply System Contactor Fault	The contactor of the water supply system has a problem with closing.	Check the contactor of the water supply system
<b>Er.EEP</b> Er.EEP (21)	Parameter Storage Failure	Parameter read-in error	Try it again after the reset. If the problem persists, seek for assistance
<b>Er.CFE</b> Er.CFE (22)	Communication Abnormality	Serious communication interference	Check the wiring and earthing of the communication loop
		The upper computer is not working	Check the upper computer and the wiring
		Inappropriate communication parameter settings	Check the settings in Menu FF

<b>Fault Display (Fault Code)</b>	<b>Fault Type</b>	<b>Possible Cause</b>	<b>Solution</b>
<b>Er.ccf</b> Er.ccf (23)	Current Detection Fault	The internal wiring of the inverter or the plug-in comes loose	Check and re-wire
		Current transducer damage or electric circuit abnormality	Seek for assistance
<b>Er.LPo</b> Er.LPo (24)	Water Level Transducer Abnormality	Water level transducer or water level switch abnormality	Check the water level transducer or water level switch
<b>Er.Aco</b> Er.Aco (25)	Analog Input Offline	Broken connection line or faulty external equipment	Check the external connection line or the external equipment
		Incorrect offline threshold settings	Check the settings of F6-07, F6-16 and F6-25
<b>Er.PLL</b> Er.PLL (26)	Clean Water Pool Water Shortage	The clean water pool water shortage transducer has a fault	Check the water level and water level transducer of the clean water pool
<b>Er.rHo</b> Er.rHo (27)	Thermal Resistor Open-Circuit	Thermal resistor offline	Check the connection of the thermal resistor or seek for assistance
<b>Er.Abb</b> Er.Abb (28)	Abnormal Shutdown Fault	The stall persists for 1 minute	Set the operating parameters correctly
		Shut down via ⊕ in the non-control panel mode	—
<b>Er.PnL</b> Er.PnL (31)	Control Panel Offline	Control panel missing or offline	—

7.2 Inverter Alarms and Solutions



List of Alarms and Solutions

Alarm Display	Alarm Name	Description	Solution	Corresponding Bit of Alarm Word
<b>AL.oLL</b> AL.oLL	Motor Overload	The thermal model detects an overhigh temperature rise	Refer to the corresponding solution to the fault	Word 1 Bit 0
<b>AL.oLP</b> AL.oLP	Motor Overload	The motor current exceeds the overload detection level and the detection time	Refer to the corresponding solution to the fault	Word 1 Bit 1
<b>AL.ULd</b> AL.ULd	Inverter Underload	The output current of the inverter is below the underload protection level and exceeds the detection time	Refer to the corresponding solution to the fault	Word 1 Bit 2
<b>AL.PnL</b> AL.PnL	Control Panel Offline	The control panel is disconnected or unconnected (the alarm signal is outputted via the terminal)	Refer to the corresponding solution to the fault	Word 1 Bit 4
<b>AL.Aco</b> AL.Aco	Analog Input Offline	The analog input signal is below the offline threshold	Refer to the corresponding solution to the fault	Word 1 Bit 5
<b>AL.PLI</b> AL.PLI	Input Phase Lack	Input phase lack or 3-phase unbalance	Refer to the corresponding solution to the fault	Word 1 Bit 6
<b>AL.PLo</b> AL.PLo	Output Phase Lack	Output phase lack	Refer to the corresponding solution to the fault	Word 1 Bit 7
<b>AL.CFE</b> AL.CFE	Abnormal Communication	Communication timeout	Refer to the corresponding solution to the fault	Word 1 Bit 8
<b>AL.EEP</b> AL.EEP	Parameter Storage Failure	Parameter read-in failure	Refer to the corresponding solution to the fault; press  to clear	Word 1 Bit 9
<b>AL.dcl</b> AL.dcl	DC Busbar Undervoltage	DC busbar voltage is lower than the undervoltage point	The poweroff display shows that the data are normal	Word 1 Bit 11
<b>AL.Pd1</b> AL.Pd1	Pump #1 Disabled	Digital Input 43 (Refer to Page 54) is effective	Check if the corresponding terminal is effective	Word 2 Bit 6
.....	.....	.....	.....	.....
<b>AL.Pd5</b> AL.Pd5	Pump #5 Disabled	Digital Input 47 (Refer to Page 54) is effective	Check if the corresponding terminal is effective	Word 2 Bit 10

<b>ALPd6</b> AL.Pd6	Small Sleeping Pump Disabled	Digital Input 48 (Refer to Page 54) is effective	Check if the corresponding terminal is effective	Word 2 Bit 11
<b>ALPd7</b> AL.Pd7	Drainage Pump Disabled	Digital Input 49 (Refer to Page 54) is effective	Check if the corresponding terminal is effective	Word 2 Bit 12
<b>ALPcE</b> AL.PcE	Parameter Check Error	Inappropriate parameter settings	Modify parameter settings or restore the factory settings; press  to clear	Word 2 Bit 1
<b>ALPdd</b> AL.Pdd	Noncompliant Control Panel Data	The parameter stored in the control panel is different from the one stored in the inverter	Press  to clear	Word 2 Bit 2
<b>ALUPF</b> AL.UPF	Parameter Uploading Failure	The panel EEPROM sounds an error alarm while the parameter is being uploaded	Check if the model number of the control panel is SB-PU70E and if the interference is too strong. Try it again.	Word 2 Bit 3
<b>ALPdE</b> AL.PdE	Control Panel Data Error	The panel has a data verification error while downloading and comparing parameters	Press  to clear	Word 2 Bit 4

7.3. Inverter Operation Abnormalities and Solutions

List of Operation Abnormalities and Solutions

Abnormality	Description	Possible Cause	Solution
Keys on the control panel do not respond	Certain keys do not respond, or no key responds	The auto lock has been actuated for keys on the panel	Hold  and  simultaneously for 3 seconds and the keys will be unlocked
		The connection line of the panel has poor contacts	Check the connection line; seek for assistance from us whenever there is an abnormality
		Keys on the panel are damaged	Replace the panel
Parameters cannot be modified	Some parameters cannot be modified	F0-10 should be set as 1 or 2	Set F0-10as 0
		The attribute of the parameters is “Read-Only”	Users are not permitted to modify read-only parameters
		Parameter modification in operation is not permitted	Modify parameters in the standby mode
The operating inverter shuts down by accident	The inverter shuts down without a shutdown command; the inverter operation indicator light goes off	There is a fault	Locate the cause and reset the fault
		The command execution channel is changed	Check the operation and the status of the command execution channel
		Fb-18 = 3 “Deceleration during Instantaneous Power Failure”; the power outage lasts too long	Check the DC busbar undervoltage action settings and the input voltage

	The motor shuts down without a shutdown command; the inverter operation indicator lamp is on	The auto fault reset is in operation	Check the auto fault reset settings and identify the cause of the fault
		The operation suspends	Check the operation suspension settings
		The set frequency is 0 and the motor is running at zero frequency	Check the frequency settings
		PID Positive Action; Feedback > Settings PID Negative Action; Feedback < Settings	Check the PID settings and feedback
The inverter fails to start after the startup command is issued; the operation indicator lamp is off		Digital Input 18 "Free Shutdown" is effective	Check the free shutdown terminal
		Digital Input 17 "Inverter Operation Disabled" is effective	Check the disablement terminal for inverter operation
		The shutdown key is not closed in Three-Wire Mode 1 or 2 or Two-Wire Mode 3	Check the shutdown button and the connection line
		The command execution channel has an error	Modify the command execution channel
		The inverter has a fault	Rectify the fault

## 8. Upkeep, Maintenance and After-Sales Service



### CAUTION

1. Only trained professionals are permitted to dismount, maintain or replace the parts and components;
2. Prior to inspection and maintenance, please confirm that the inverter has been disconnected from the power supply and that the voltage between P+ and N- is lower than 36V; otherwise there may be hazards of electric shocks;
3. Do not leave any metal part, e.g. screws and washers, in the machine; otherwise there may be hazards of equipment damage and fire;
4. After the control panel is replaced, set the relevant parameters prior to operation; otherwise, there may be hazards of equipment damage.

### 8.1. Daily Upkeep and Maintenance

Inverters may break down as a result of ambient conditions (dust, damp and vibration, etc.) and aging or deteriorating devices. Therefore, it is necessary to check a inverter and its operating environment at regular intervals. It is a good idea to maintain a sound operating environment, keep daily operation records and identify abnormalities as early as possible for an extended service life. Remember to check the following points in daily maintenance of inverters:

1. Check if the operating environment conforms to the requirements;
2. Check if the operating parameters of the inverter are within the prescribed range;
3. Check if there is any abnormal vibration or noise;
4. Check if there is any abnormal smell;
5. Check if the fans are working well;
6. Check if the input voltage is within the prescribed range and if different phases have balanced voltage?

### 8.2. Regular Maintenance

The user may check the inverter on a 3-month or 6-month basis, depending on the operating environment. Generally, the following items must be checked:

1. Check if the screws for the control terminals have come loose;
2. Check if the main loop terminal has any poor contact and if the connection of copper bars has marks of overheat;
3. Check if the power cables and control cables have any damage, especially scoring marks where the cables are in contact with metal surfaces;
4. Check if the insulation bands on the cold-pressed terminals of the power cables have come off;

5. Clean away dust on the circuit board and the air duct thoroughly. A dust cleaner is recommended;
6. If an inverter is to be stored for long, it must be subject to a 5-hour energizing test within 2 years. During the energizing test, step up the voltage slowly to a rated value with a voltage regulator. Loads may be dropped.



CAUTION: If an insulation test is required for the motor, the motor must be disconnected from the inverter and be subjected to an independent test; otherwise the inverter may be damaged.



CAUTION: Do not conduct withstanding voltage tests or insulation tests on the control loop; otherwise electrical circuit elements may be damaged.

### 8.3. Replacement of Inverter Wearing Parts

The inverter wearing parts primarily include the electrolytic capacitor (used for wave filtration) and the cooling fan. The service life and the service environment are closely related to maintenance conditions.

The user can decide whether to change the wearing parts according to the operating time.

#### ◆ Cooling Fan

Possible Cause for Damage: Bearing abrasion and blade aging (the fan life is normally 30,000—40,000 hours);

Judgment Criterion: Cracks on fan blades; abnormal vibration noise during startup.

NOTE:

1. The replacement must be a fan of the same specification (rated voltage, current, rotation speed and air volume) as recommended by the manufacturer;
2. During installation, see to it that the indicated direction of the fan must be the same as the blasting direction.
3. Remember to install a protective hood.

#### ◆ Wave-Filtering Electrolytic Capacitor

Possible Cause for Damage: As the ambient temperature is high, the frequent load jumps causes the pulsating current to increase in intensity; therefore the electrolyte ages and deteriorates.

Judgment Criterion: Liquid leak, bulged safety valve, electrostatic capacity measurement and insulation resistance measurement.

It is recommended that the busbar electrolytic capacitor be replaced every 4 or 5 years.

### 8.4. Storage of Inverters

After purchasing the inverter, the user must advert to the following points on temporary/longtime storage:

- ◆ Avoid storage in high-temperature, high-humidity environments filled with dust and metal dust;
- ◆ Longtime storage will cause the electrolytic capacitor to deteriorate. The inverter must be charged at least once every two years for a min. of 5 hours. User a voltage regulator to step up the input voltage slowly to the rated voltage.

### **8.5. After-Sales Service**

The warranty is effective for 12 months commencing from the date of purchase. However, in any of the following cases, the repair will be non-gratuitous notwithstanding a warranty period:

1. Any damage arising from noncompliance with the user's manual;
2. Any damage arising from unauthorized modification of the product;
3. Any damage arising from above-norm use;
4. Any damage caused by falls or in transit;
5. Any damage arising from fire, flood, abnormal voltage or lightning strike;

In the event of any abnormality arising in operation, check and adjust the inverter as per the user's manual. In case any fault occurs, promptly contact the supplier, the local electrical engineering agent of Hope-Senlan Technologies Corporation or our headquarters. We will rectify any fault for free that arises from manufacturing and design within the warranty period. For a rectification beyond the warranty period, we will charge the user as required at a reasonable rate.

## 9. Optional Fittings

The user can order and we will provide on demand any of the following fittings:

### 9.1 Braking Units

The braking unit and the braking resistor are combined to absorb the electrical energy regenerated by the braking of the motor. This combination can be used both for Senlan® inverters and other inverters. Inverters with inbuilt braking units only need to be fitted with a proper braking resistor, while those without an inbuilt braking unit must be fitted with an appropriate external braking unit and a braking resistor.

Wiring Diagram of the Braking Unit, Braking Resistor and Inverter:

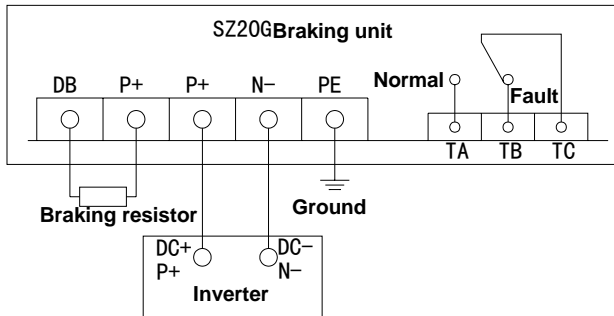

The length of the connection line between the braking unit and the inverter, or between the braking unit and the braking resistor, must be within 5m, and it is necessary to ensure the enclosed area of the loop is the smallest.

Refer to the following table for the specification of Senlan® SZ braking unit series:

Braking Unit Model Number	Resistance (Ω)	Appropriate Inverter (kW)	Braking Voltage (V)
SZ20G-30	≥22	18.5/22	680
SZ20G-60	≥11	30/37	680
SZ20G-85	≥8	45/55	680
SZ20G-130	≥5	75/90	680
SZ20G-170	≥4	110	680
SZ20G-260	≥2.6	132/160	680
SZ20G-380	≥1.8	200/250	680

NOTE: A resistance higher than the ratings recommended by the table will cause an attenuated braking force. Normally, the resistance should not exceed 1.5—2.0 times the recommended resistance.

## 9.2 Communication Components

- Communication cables for the Control Panel

Communication cables are used to connect the inverter mainframe to the control panel. They are available in two types, 30kW and above and 22kW and below. Cable length is customizable.

- Background monitoring software (SbMonitor)

The software is used to monitor the operation of the inverter real-time in order to centralize the management of inverter operation.

## 9.3 AC Reactor on the Input Side

An AC reactor on the input side can be used to control the higher harmonics generated by the input current of an inverter and improve the power factor on the input side. It is recommended in the following cases:

- When the capacity of the power grid is much larger than the capacity of the inverter and the inverter power exceeds 30kW;
- When there are thyristor loads or power factor compensation devices (with control switches) connected to the same power supply;
- When the voltage unbalance of the 3-phase power supply exceeds 3%;
- When the power factor of the input side needs to be improved.

## 9.4 EMI Filter and Ferrite Chip Common Mode Filter

EMI filters are used to control the radiation interference generated by a inverter, or the interference generated by external radio interference, transient surge or inrush current. The ferrite chip common mode filter (magnetic core) is used to control the radiation interference generated by the inverter.

In cases where there are high requirements for radio interference resistance and compliance with CE, UL and CSA standards is required, or where equipment with poor interference resistance capacity is mounted adjacent to the inverter, a filter must be used. Check that the connection line length is minimized during installation and the filter must lie as close to the inverter as possible.

## 9.5. Digital I/O Extension Board

The digital I/O extension board is used to expand the number of digital I/O terminals.

Installation: (1) confirm that the inverter has been disconnected from the power supply; (2) insert the bigger end of the plastic pole (complimentary) into the main control panel; (3) Aim the socket of the extension board at the pins (J1) at the interface of the main control panel, aim the two installation holes on the extension board at the plastic pole and push it in place.

Refer to the following diagram for basic wiring:

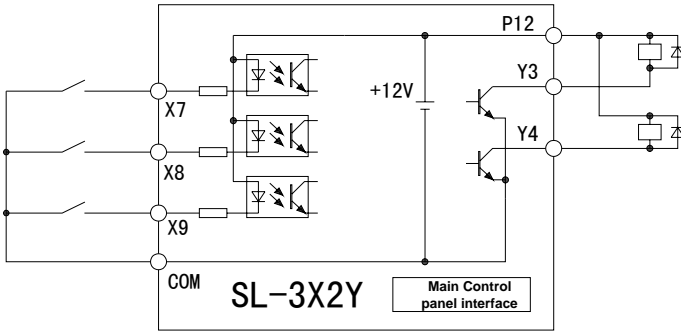

The digital I/O extension board provides customizable multiplex digital input/output quantities, such as 5-channel digital input (SL-5X), 5-channel digital output (SL-5Y) and 3-channel digital input/2-channel digital output (SL-3X2Y). Take SL-3X2Y for example. Refer to the following table for functions and specification:

Terminal Code	Terminal Name	Terminal Function and Description	Technical Specification
X7	X7 Extension Input Terminal	Multifunction: Refer to Menu Fd for settings Monitoring Parameter: FU-29	Opto-isolator Input impedance: $\geq 3.9k\Omega$ Sampling period: 2ms Input voltage range: $< 25V$ High level: $> 10V$ Low level: $< 3V$
X8	X8 Extension Input Terminal		
X9	X9 Extension Input Terminal		
P12	12V Power Supply Terminal	12V power supply for the user	12V Max. output current (12V): 80mA
COM		12V Earth terminal	
Y3	Y3 Extension Output Terminal	Multifunction: See Menu Fd for settings Monitoring Parameter: FU-30	Opto-isolator Output Action Frequency: $< 250Hz$ Collector open-circuit output Break-over voltage: $< 1.0V$ Specification: 24Vdc/50mA
Y4	Y4 Extension Output Terminal		

### 9.6 Relay Extension Unit (SL-5X6T)

The programmable relay extension unit (SL-5X6T) is used to expand the number of digital input/relay output interfaces.

Installation: (1) Confirm that the inverter has been disconnected from the power supply; (2) connect the interface bus of the control unit to the pins of the inverter mainboard (J5) and see to it that Pin 1 of the socket connector adapts to Pin 1 of J5.

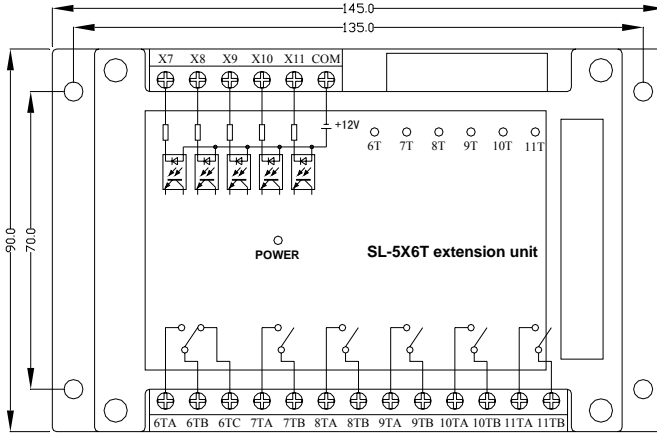

Refer to the following table for the functions and specifications of the programmable relay extension unit terminals:

Terminal Code	Terminal Name	Terminal Function and Description	Technical Specification	
X7	X7 Extension Input Terminal	Multifunction; see Menu F4 for settings Monitoring parameter: FU-29	Opto-isolator Input impedance: $\geq 3.9k\Omega$ Sampling period: 2ms	Input voltage range: < 25V High level: > 10V Low level: < 3V
X8	X8 Extension Input Terminal			
X9	X9 Extension Input Terminal			
X10	X10 Extension Input Terminal			
X11	X11 Extension Input Terminal			
COM	Extension input earth terminal	Extension input earth terminal		
6TA	Output Terminal of Relay 6	See Menu F5 for function options and settings	TA-TB: Constantly open TB-TC: Constantly closed Contact specification: 250V <sub>AC</sub> /3A 24V <sub>DC</sub> /5A	
6TB				
6TC				
7TA	Output Terminal of Relay 7			
7TB				
8TA	Output Terminal of Relay 8			
8TB				
9TA	Output Terminal of Relay 9			
9TB				

Terminal Code	Terminal Name	Terminal Function and Description	Technical Specification
10TA	Output Terminal of Relay 10		
10TB			
11TA	Output Terminal of Relay 11		
11TB			

**9.7 Control Panel Complete with Parameter Copying (SB-PU70E)**

SB-PU70E control panels can realize the function of F0-12 “Parameter Copying”, which is especially useful in the case of more than one inverter with the same settings.







**9.8 LCD Control Panel Complete with Parameter Copying (SB-PU 200; Simplified Chinese Version)**

The control panel of an inverter is used to receive commands and display parameters. With a SB-PU200 control panel, the user can set or check parameters, exercise operation control, display information on faults & alarms, enable the real-time clock and copy parameters. See the following figure for a control panel.



**9.8.1. SB-PU200: Keys**

Icon	Key Name	Function
	NAVIGATE	The function corresponding with the display of a specific position will be realized

	INCREASE	Increase of numbers or menus; when this key is pressed, the increase speed will accelerate
	DECREASE	Decrease of numbers of menus; when this key is pressed, the decrease speed will decelerate
	SHIFT	Used to select the digit to be modified; in monitoring mode, this key is used to switch between monitoring parameters; In menu selection, the key can be used to turn pages
	EXECUTE	Execution of a command
	STOP/RESET	Shutdown or fault reset
	HELP	When “?” is displayed, press the key to display help information

9.8.2. SB-PU200 Display Interface

Refer to the following figure for the fundamental architecture of the LCD control panel:

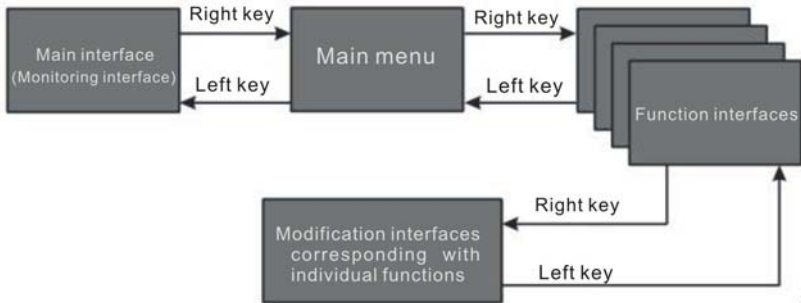

9.8.3. Main Menu

In the monitoring interface mode, press the right navigation key (Menu) to enter the main menu. Make selections with UP or DOWN (press SHIIF to turn pages). The main menu has the 9 following functions:

Code	Name	Description
00	Parameter Setting	Settings of parameters relevant to the inverter
01	Water Supply	Entry into functions relevant to water supply
02	PID Controller	Entry into functions relevant to PID control
03	I/O Port Settings	Entry into functions relevant to I/O ports
04	I/O Port Status	Check of the status of I/O ports; when the digital port is selected, the box behind the port becomes black

05	Parameters Backup	Parameter uploading, downloading and comparison of difference
06	Fault Records	Check of the latest faults recorded by the inverter
07	Modified Parameters	Check parameters different from the factory settings
08	User Parameters	The user can add common functions to the list and modify them.
09	LCD Settings	Refer to the LCD setting menu for details

9.8.4. LCD Setting Menu

The following operations can be done in the LCD setting menu:

Name	Description
LCD Contrast Adjustment	Adjustment of LCD contrast to achieve the best display effect
Time Settings	System time settings (24 hours)
Monitoring Menu Font	Used to set the font of monitoring parameters & data on the main interface
Monitored Item Switching Time	Used to set the auto switching time (x second(s); switching is inapplicable when x is equal to 0) of the monitored item
^/\v Setting Options	Used to modify or disable the main frequency settings and PID digital settings by pressing ^ or \v on the main interface
LCD Software Version	The software version number of the current LCD control panel
Monitored Item Options	Used to modify the monitoring parameters of the main interface; 6 parameters in all

9.8.5. Main Interface:

The main interface has two monitoring interface versions: big font and small font. The font format can be modified via the LCD setting menu.

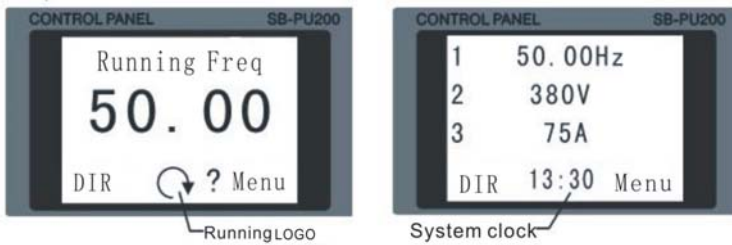

The running logo reflects the current operation conditions of the inverter. The clockwise icon indicates that the inverter is rotating in a clockwise direction and the anticlockwise icon indicates an anticlockwise rotation. If the logo is represented in broken lines, it means that the inverter is in an acceleration/deceleration process. The operation logo and the system time are displayed alternately.

The user can modify the frequency settings or digital PID settings via the main interface. This is done by using “^” or “\v” (setting options) in the “LCD settings” menu. The following picture will be displayed when the set frequency is being modified:

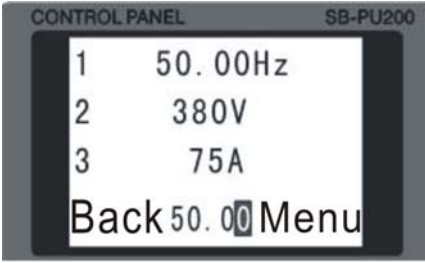

I/O Port Status Monitoring:

Select “04 I/O Port Status Menu” in “Main Menu” to check the status of Terminal X, Terminal Y, Relay Terminal and Analog Input Terminal.

Monitoring Interface of Terminal X:

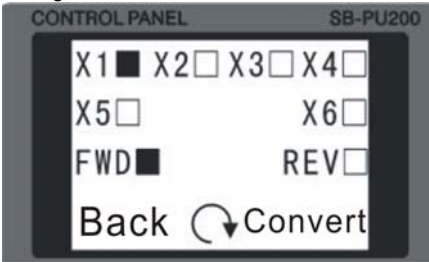

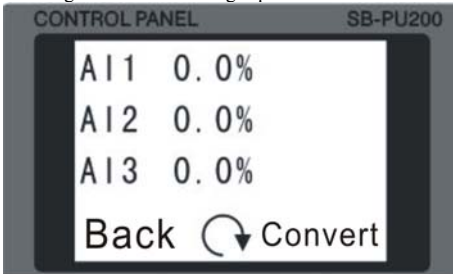

“” means Terminal X (Terminal Y or Relay Terminal) is short-circuited; “” means that they are not off.

Monitoring Interface of Analog Input Terminal:

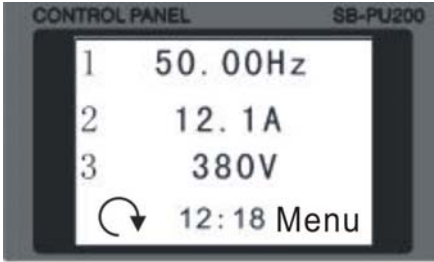

Example: Modification of the Function of F0-00



Press "Menu" (Right  key) to enter the interface of the main menu

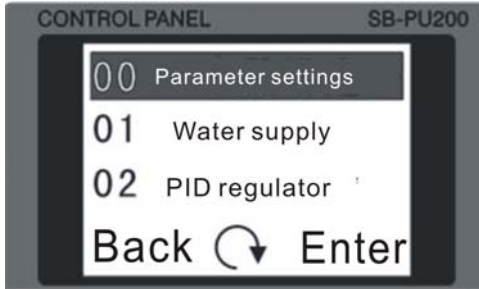

Press "Enter" (Right  Key) to enter the interface of function options

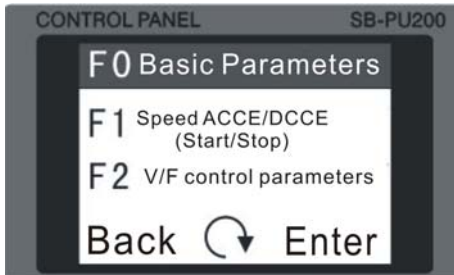

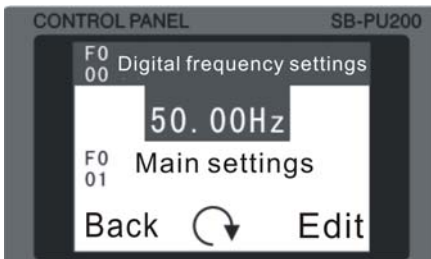

Press "Enter" (Right  Key) to enter the interface of function options



Press "Edit" (Right  key) to enter the interface of function editing

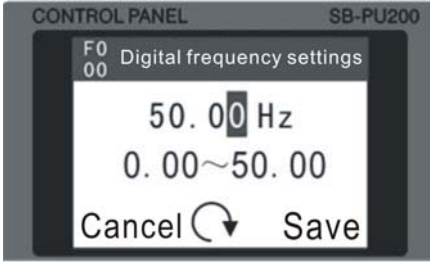

---



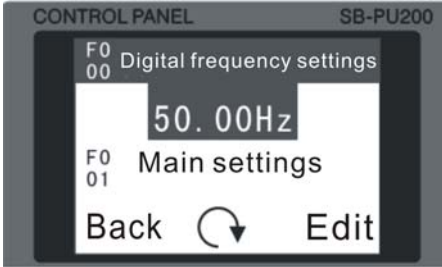

Modify with “SHIFT” and “INSERT/DELETE”, press “SAVE” (right  key) and return to the interface of function options



9.8.6 Description of Key Combinations

Keyboard Lock: If modification of FC-01 functions is required, hold  and press the right  key to lock the keyboard. After that, the system will return to the monitoring interface.

Keyboard Unlock: Hold  and  for more than 3 seconds.

9.9. Control Panel Mounting Box

This is used to mount the control panel on the cabinet. For installation dimensions, refer to 3.2.3. “Installation of Control Panel on Cabinet Panel”

## 10. Application Examples

### 10.1. Example 1: Two Variable-Frequency Cyclic Switchover Pumps (under Common Control) plus One Auxiliary Pump

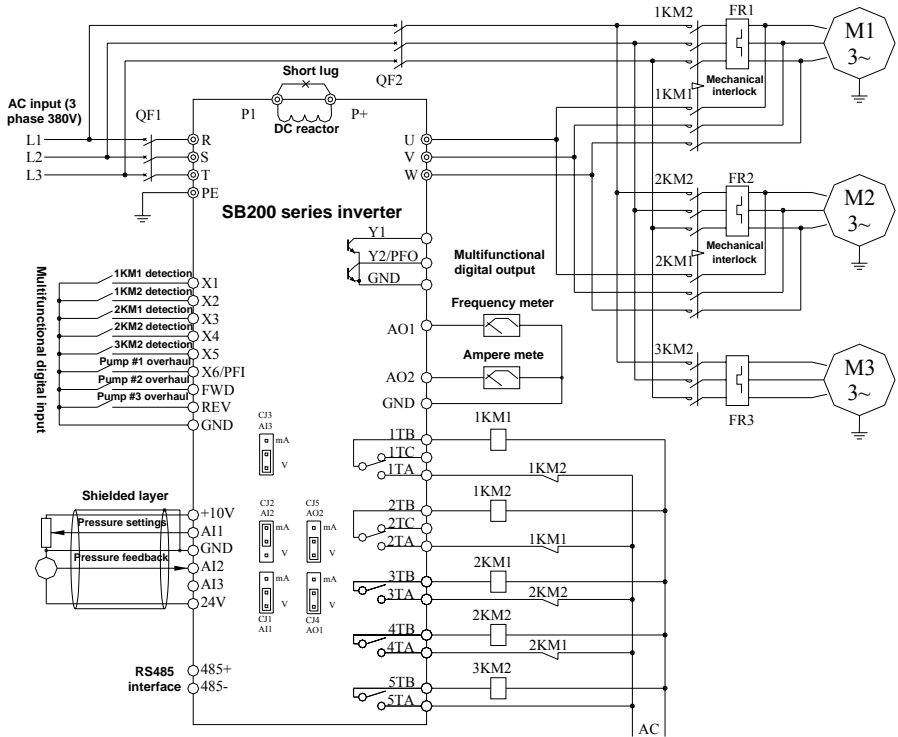

Application Drawing of Two Variable-Frequencies Cyclic Switchover Pumps (under Common Control) plus One Auxiliary Pump

Two Variable-Frequency Cyclic Switchover Pumps (under Common Control) plus One Auxiliary Pump

Reference: Parameter Settings in the application of Two Variable-Frequency Cyclic Switchover Pumps plus One Auxiliary Pump

F0-02=0: Inverter startup/shutdown via the control panel

F4-00=22: X1 is selected as the detection input for Contactor 1K1

F4-01=23: X2 is selected as the detection input for Contactor 1K2

F4-02=24: X3 is selected as the detection input for Contactor 2K1

F4-03=25: X4 is selected as the detection input for Contactor 2K2

F4-04=27: X5 is selected as the disablement input (overhaul command) for Pump #1

F4-05=43: X6 is selected as the disablement input (overhaul command) for Pump #1

F4-11=44: FWD is selected as the disablement input (overhaul command) for Pump #2

F4-12=45: REV is selected as the disablement input (overhaul command) for Pump #3

F5-02=24: Relay T1 is selected as the control output for Pump #1 (variable-frequency operation)

- F5-03=25: Relay T2 is selected as the control output for Pump #1 (line frequency operation)
- F5-04=26: Relay T3 is selected as the control output for Pump #2 (variable frequency operation)
- F5-05=27: Relay T4 is selected as the control output for Pump #2 (line frequency operation)
- F5-06=28: Relay T5 is selected as the control output for Pump #3 (line frequency operation)
- F7-00=3: PID control is selected to set constant-pressure water supply frequency
- F7-01=1: AI1 is selected as the signal input for pressure settings
- F7-02=1: AI2 is selected as the signal input for pressure feedback
- F7-03: Set as per the measurement range of the pressure transducer
- F8-00=1: Common PI-regulated water supply is selected
- F8-01 = 03012: Settings: Number of Variable Frequency Pumps: 2; Number of Line-Frequency Auxiliary Pumps: 1; Sleeping Mode: Main Pump Sleeping
- F8-24 and F8-25: Respectively set according to the min. outflow frequencies of Pumps #1 and #2
- F8-30 and F8-31: Respectively set according to the rated current (nameplate parameters) of Pumps #1 and #2

Time Sequence of System Operation:

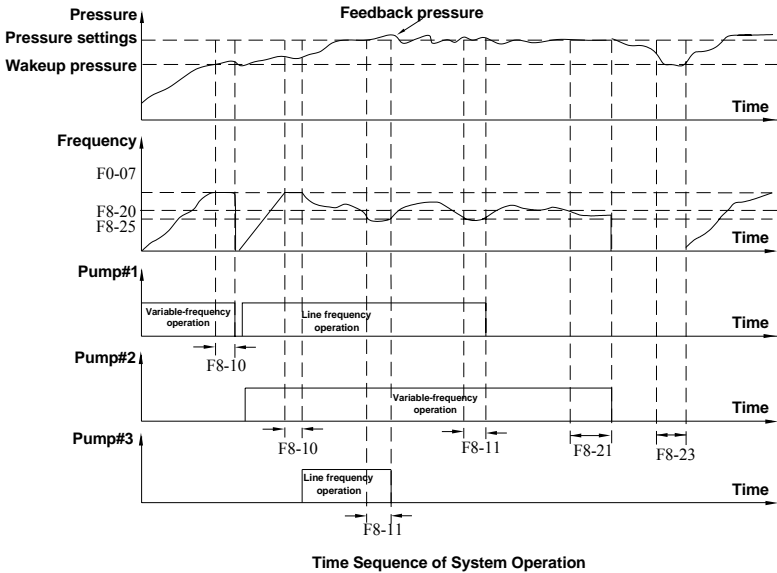

### 10.2. Example 2: Constant Pressure Water Supply by Inverter plus Soft Starter

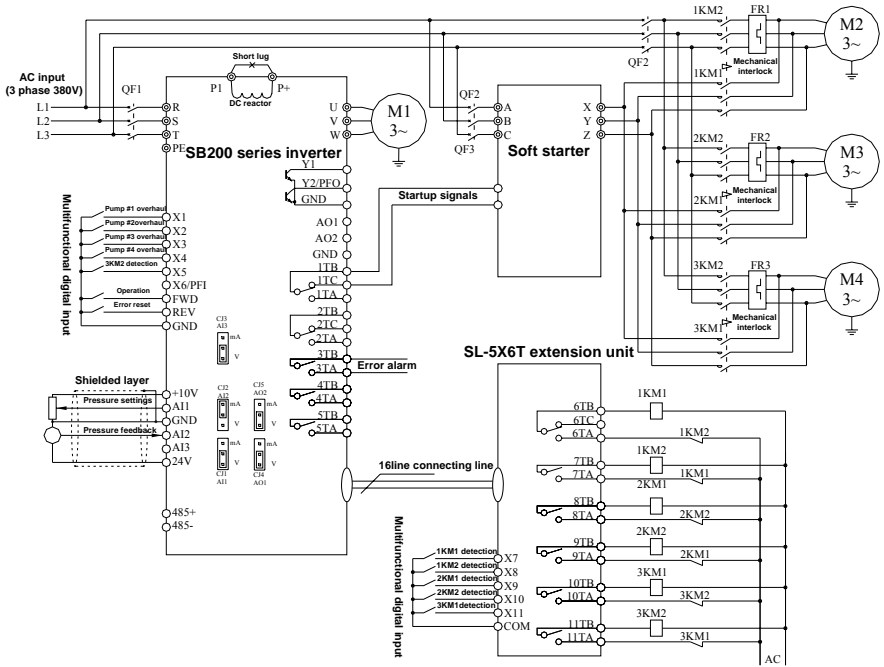

**Application Drawing of Constant Pressure Water Supply by Inverter plus Soft Starter**

Reference: Parameter Settings in the Application of Inverter plus Soft Starter to Constant-Pressure Water Supply:

- F4-00=43: X1 is selected as the disablement input (overhaul command) for Pump #1
- F4-01=44: X2 is selected as the disablement input (overhaul command) for Pump #2
- F4-02=45: X3 is selected as the disablement input (overhaul command) for Pump #3
- F4-03=46: X4 is selected as the disablement input (overhaul command) for Pump #4
- F4-04=29: X5 is selected as the detection input for Contactor 3K2
- F4-06=24: X7 is selected as the detection input for Contactor 1K1
- F4-07=25: X8 is selected as the detection input for Contactor 1K2
- F4-08=26: X9 is selected as the detection input for Contactor 2K1
- F4-09=27: X10 is selected as the detection input for Contactor 2K2
- F4-10=28: X11 is selected as the detection input for Contactor 3K1
- F4-11=38: FWD is selected as the operation command input
- F4-12=13: REC is selected as the fault reset command input
- F5-02=49: Relay T1 is selected as the soft starter startup signal control output
- F5-04=13: Relay T3 is selected as the fault alarm output
- F5-07=26: Relay T6 is selected as the operation control output for the soft starter of Pump #2
- F5-08=27: Relay T7 is selected as the line frequency operation control output for Pump #2
- F5-09=28: Relay T8 is selected as the operation control output for the soft starter of Pump #3
- F5-10=29: Relay T9 is selected as the line-frequency operation control output for Pump #3
- F5-11=30: Relay T10 is selected as the operation control output for the soft starter of Pump #4
- F5-12=31: Relay T11 is selected as the line frequency operation control output for Pump #4
- F7-00=3: PID control is selected to set the frequency of constant-pressure water supply
- F7-01=1: A11 is selected as the pressure setting signal input.
- F7-02=1: A12 is selected as the pressure feedback signal input.

F7-03: Set according to the measurement range of the pressure transducer

F8-00=1: Common PI-regulated constant pressure water supply is selected

F8-01= 03031: Settings: Number of Variable Frequency Circulator Pumps: 1; Number of Line Frequency Auxiliary Pumps: 3; Sleeping Mode: Main Pump Sleeping

F8-24: Set according to the min. outflow frequency of Pump #1

F8-30: Set according to the rated current (nameplate parameter) of Pump #1

## 11 Version Information

### New Functions:

1. Amendments to F7-02: 10: MAX (AI1, AI3) 11: MIN (AI1, AI3)
2. Amendment to Table of Definitions of Digital Output Functions: #60: AI1 > AI3  
Amendment to Table of Definitions of Digital Output Functions: 60: AI1>AI3. It is used to indicate the status where AI1>AI3.  
(Software Version: V0.03 and later)
3. Pump disablement is added to F8-44~F8-50 (Software Version: V0.05 and later). See Page 56.
4. Amendment: Check option items (motor options) for Digital Input Functions “43 and 44” are added. See Page 101.
5. Amendment to the User’s Manual of Version SB200V1.2 (Software Version: V0.06 and later)
  1. Output of Monitor 2 is added. See Page 107.
6. Amendments to the User’s Manual of Version SB200V1.3 (Software Version: V0.07 and later)
  1. Digital Input Terminal functions “55, 56 and 57”. See Page 101;
  2. F8-39: Pump Startup Sequence Options: See Page 141;
  3. F8-51: Standby Pump Number Settings. See Page 143.

- The contents of this manual are subject to change without notice

**Hope Senlan Science & Technology Holding Corp., Ltd.**

Add: 181 Airport Road, Chengdu, P.R. China (610225)  
Web: [www.slanvert.com](http://www.slanvert.com)  
E-mail: [info@chinavvf.com](mailto:info@chinavvf.com)  
Tel: 86-28-85964751  
Fax: 86-28-85962488