

ED3100 Series Frequency Inverter

Instruction Manual (V1.1)

Shenzhen Easydrive Inverter Technology Co. Ltd.

Addr: Shenzhen Easydrive Inverter Technology Co. Ltd.

Preface

----Thanks for using ED3100 series high performance vector control inverter manufactured by Shenzhen Easydrive Frequency Inverting Technology Co. Ltd.

----- Based on ED3000 series and adopting completely new conception, ED3100 series inverter is a type of sensorless current vector inverter independently developed by Shenzhen Easydrive Inverter Technology Co. Ltd. On premise of enhancing stability, more advanced functions are available, like motor constant self-identification, analog current input, switch value input, flexible frequency setting method , online switch of multiple frequency setting methods, online constant modification, pulse frequency setting, power failure constant memory, transverse operation with fixed amplitude and variable amplitude, RS485 communication, etc. ED3100 provides manufacturers and ender users with highly integrated all-in-one solution. It is greatly helpful for cutting down the purchasing cost and company operation cost, and improving the system's reliability.

----- Before using ED3100 series Inverter, please let the users and technicians read this manual carefully to make sure correctly install and operate the inverter so that the inverter could exert its best performance.

-----The content of the manual could be updated without prior notice. Please follow up the new version.

To readers

This manual is suited for below readers:

---Inverter installation staff, engineer technician(electric engineer, electric operator), designers

---Please make sure that this manual will reach to the ender users.

Convention

Symbol Convention



Warning ---- Indicates precautions that if not heeded, could possibly result in medium injury or light injury.



Caution ---- Indicates precautions that if not heeded, could possibly result in loss of life or serious injury.

-- Contents

Chapter 1 Introduction

- 1.1 Product Confirmation----- (5)
- 1.2 Safety Precautions----- (6)
- 1.3 Usage Precautions----- (8)
- 1.4 Scrap Precautions----- (9)

Chapter 2 Products SPEC. and Order Information

- 2.1 Inverter Models----- (10)
- 2.2 Products Technical SPEC.----- (11)
- 2.3 Inverter Exterior Description----- (13)
- 2.4 Exterior Dimensions----- (13)
- 2.5 Choosing Accessory----- (17)

Chapter 3 Inverter Installation and Wiring

- 3.1 Inverter Install Environment----- (19)
- 3.2 Inverter Panel Dismantle and Install----- (20)
- 3.3 Inverter Wiring Precautions----- (20)
- 3.4 Wiring Main Circuit Terminals----- (21)
- 3.5 Main Circuit Wiring Diagram----- (25)
- 3.6 Control Circuit Wiring----- (27)
- 3.7 Safety Precautions to EMC standard----- (31)

Chapter 4 Inverter Running and Operation Description

- 4.1 Inverter Operation----- (33)
- 4.2 Keyboard Operation and Usage----- (34)
- 4.3 Inverter Power Up----- (38)

Chapter 5 Constant List

- 5.1 Symbol Description----- (39)
- 5.2 Constant List----- (39)

Chapter 6 Constant Detail Description

- 6.1 Basic Running Constant (P0.00—P0.23) ----- (56)
- 6.2 Motor and Vector Control Constant (P1.00—P1.15) ----- (66)
- 6.3 Auxiliary Running Constant (P2.00—P2.43) ----- (69)
- 6.4 User Management Interface Constant (P3.00—P3.09) ----- (77)
- 6.5 Switching Value Input &Output Constant(P4.00—P4.16)----- (79)
- 6.6 Simulation Input & Output Constant (P5.00—P5.16) ----- (88)
- 6.7 Process PID Control Constant (P6.00—P6.14) ----- (93)
- 6.8 Programming Constant (P7.00—P7.18) ----- (100)
- 6.9 Communication Constant (P8.00—P8.04) ----- (105)
- 6.10 Protection Constant (P9.00—P9.03) ----- (107)
- 6.11 Advance Function Constant (PA.00—PA.06) ----- (109)

Chapter 7 Troubleshooting

- 7.1 Malfunction Phenomenon and Countermeasure----- (112)
- 7.2 Malfunction Record Checking----- (112)
- 7.3 Malfunction Resetting----- (112)
- Malfunction Code and Countermeasure----- (113)

Chapter 8 Maintenance and Inspection

- 8.1 Daily Maintenance----- (116)
- 8.2 Routine Maintenance----- (116)
- 8.3 Maintenance of Parts----- (117)

Chapter 1 Introduction

1.1 Product Confirmation

Before open the box, please check carefully: if there's any damage or scratch during transportation, if the Rated Power on the nameplate of the unit is in agreement with your order.

If found any defective, please contact the agent or contact directly with our company.

Inverter Model Description:

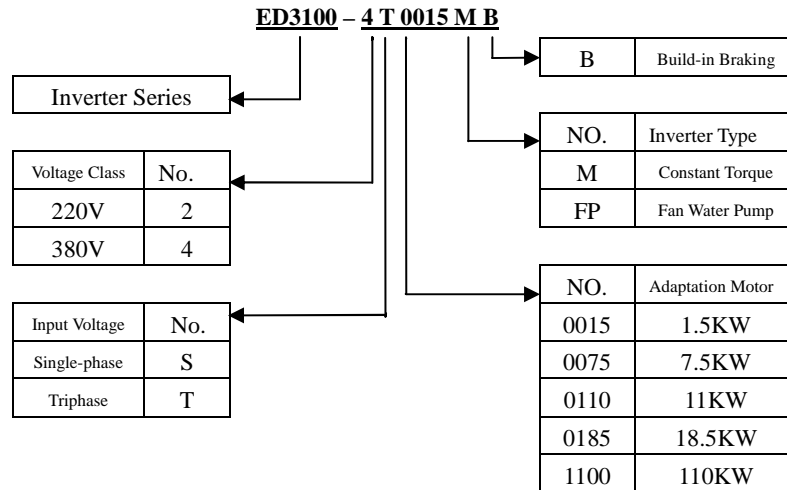

Remarks: ED3100-DC 。

Stands for DC Buss share model

Inverter symbol description

:
On the bottom of the side panel of the inverter, there's a nameplate with Model & Rated Power attached, details as below:



Fig. 1-2 Inverter Nameplate

1.2 Safety Precautions

- **Confirmation upon delivery**

 CAUTION
<p>Never install an Inverter that is damaged or missing components Doing so can result in injury</p>

- **Installation**

 CAUTION
<ol style="list-style-type: none"> 1. Always hold the case when carrying the Inverter If the Inverter is held by the front cover, the main body of the Inverter may fall, possibly result in injury. 2. Attach the Inverter to a metal or other noncombustible material. Fire can result if the Inverter is attached to a combustible material

- 3. Install a cooling fan or other cooling device when installing more than one Inverter in the same enclosure so that the temperature of the air entering the Inverter is below 40 degree.**

Overheating can result in fires or other accidents.

● **Wiring**



WARNING

- 1. Always turn OFF the input power supply before wiring terminals..**

Otherwise, an electric shock or fire can occur

- 2. Wiring must be performed by an authorized person qualified in electrical work.**

Otherwise, an electric shock or fire can occur

- 3. Be sure to ground the ground terminal.**

Otherwise, an electric shock can occur.

- 4. Always check the operation of any emergency stop circuit after they are wired.**

Otherwise, there is the possibility of injury. (Wiring is the responsibility of the user).

- 5. Never touch the output terminals directly with your hands or allow the output lines to come into contact with the Inverter case. Never short the output circuits.**

Otherwise, electrical shock or grounding can occur.



CAUTION

1. **Check to be sure that the Voltage of the main AC power supply agree with the rated voltage of the Inverter.**

Injury or fire can occur if the voltage is not correct.

2. **Do not perform voltage withstand test on the Inverter.**

Otherwise, semiconductor elements and other devices can be damaged.

3. **Connect braking resistors, Braking Resistor Units, and Braking Units as shown in the I/O wiring examples.**

Otherwise, a fire can occur.

4. **Tighten all terminal screws to the specified tightening torque.**

Otherwise, a fire may occur.

5. **Do not connect AC power to the output terminal U, V, W.**

The interior parts of the Inverter will be damaged if voltage is applied to the output terminals.

6. **Do not connect phase-shift capacitors or LC/RC noise filters to the output circuits.**The Inverter can be damaged or internal parts burnt if these devices are connected.

7. **Do not connect electromagnetic switches or contactors to the output circuits.**

If a load is connected while the Inverter is operating, surge current will cause the over current protection circuits inside the Inverter to operate.

- **Maintenance and Inspection**



WARNING

- 1. Do not touch the Inverter terminals. Some of the terminals carry high voltages and are extremely dangerous.**

Doing so can result in electric shock.

- 2. Always have the protective cover in place when power is being supplied to the Inverter. When attach the cover, always turn off power to the Inverter .**

Doing so can result in electric shock.

- 3. Maintenance, inspection must be performed only by authorized personnel.**

Failure to heed these warning can result in electric shock.



CAUTION

- 1. A CMOS IC is used in the control board, handle the control board and CMOS IC carefully.**

The CMOS IC can be destroyed by static electricity if touched directly.

- 2. Do not change the wiring, or remove connectors during operation.**

Do not check signal during operation

Otherwise it will injure the equipment.

1.3 Usage precautions.

When using ED3100 series Inverter, please pay attention to below points:

1、Constant Torque Operate in low speed

The Inverter' s lifetime will be shorten if operate in low speed for long time due to poor heat dissipation. Should choose professional Inverter if the constant low speed torque will operate for long time.

2、confirmation of motor' s insulation

----- When using ED3100 Series Inverter, please make sure that the motor is insulated, otherwise will result in injury in the unit. Besides, if the Inverter is operated under bad circumstance, please check its insulation periodically to make sure system' s safe operation.

3、Negative Torque Load

There will always arise Negative Torque happens when increase Loading. The Inverter will trip due to Over current or Overpressure. In this case it is necessary to consider using braking resistor.

4. mechanical resonance point of load device

Within certain output frequency, the inverter could meet mechanical resonance point of the load device. It must be avoided by setting jump frequency.

5. Capacitor or voltage-sensitive parts to improve power factor

Since the output voltage of the inverter is pulse wave, if the output side is installed with capacitors or lightningproof voltage-sensitive resistor, it will cause the inverter failure trip or components breaking, and they must be removed. Besides, air switch and contactor or other switch components are not recommended to use on the output side. Please see fig. 1-3. (If switch is necessary, please make sure that the output current is “ zero” when the switch operates.

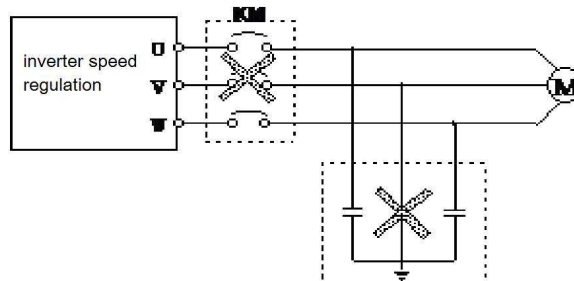

Fig.1-3 Capacitor is not permitted to use at the output side of inverter

6. To operate with frequency above 50Hz

If the frequency exceeds 50Hz, it is not only necessary to consider the rise of motor vibration and noise, but also to make sure that the speed range of the motor bearing and mechanical devices. Please do check in advance.

7. Motor electronic heat protection value

---When choosing adaptation motor, the inverter can perform heat protection on the motor. While, if motor's rated capacity is not compatible with the inverter, the protection value must be adjusted or other protection measure needs to be taken to make sure the motor's

operation safty.

8、Altitude and derating usage

--- When the altitude is above 1000meters, the heat dissipation of the inverter will become worse due to thin air, derating usage is necessary. Please see fig.1-4, the relation curve between the rated current of the inverter and altitude

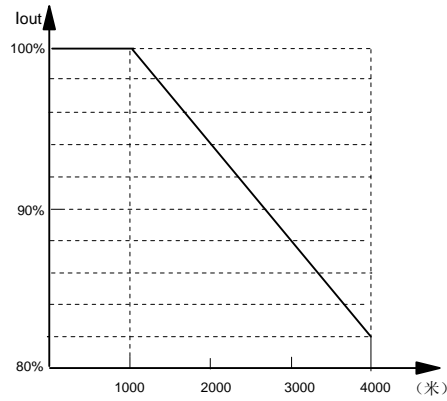

Fig. 1-4 derating usage illustration of inverter' s rated output current and altitude

9、Protection Level

ED3100 series Inverter's protection class IP20 is achieved under operation or display of keyboard.

1.4 Scrap Precautions

When the Inverter is rejected, please pay attention to the following:

Explosion could happen when burning capacitors on main circuit and PCB. Sometimes it will produce poisonous gas when burning plastic parts. Please dispose them as industrial rubbish.

Chapter 2 Product Specification and Order Information

2.1 Inverter Series Model Nos.

ED3100 series Inverter has got two voltage class: 220V & 380V, adaptive motor's power range: 0.75KW~400KW, model as below

Table 2-1 ED3100 ED3100 series Inverter Model Nos.

Voltage Class	Inverter Model NO.	Rated Output Current (A)	Adaptation Motor (KW)
380V triphase	ED3100-4T0007M	2.3	0.75
	ED3100-4T0015M	3.7	1.5
	ED3100-4T0022M	5.5	2.2
	ED3100-4T0040M	8.5	4.0
	ED3100-4T0055M	13.0	5.5
	ED3100-4T0075M	17.0	7.5
	ED3100-4T0110M	25.0	11
	ED3100-4T0150M	33.0	15
	ED3100-4T0185M	39.0	18.5
	ED3100-4T0220M	45.0	22
	ED3100-4T0300M	60.0	30
	ED3100-4T0370M	75.0	37
	ED3100-4T0450M	91.0	45
	ED3100-4T0550M	112.0	55
	ED3100-4T0750M	150.0	75
	ED3100-4T0930M	176.0	90
	ED3100-4T1100M	210.0	110
	ED3100-4T1320M	260.0	132
	ED3100-4T1600M	310.0	160
	ED3100-4T1850M	340.0	185
	ED3100-4T2000M	385.0	200
	ED3100-4T2200M	430.0	220
	ED3100-4T2500M	475.0	245
ED3100-4T2800M	535.0	280	

	ED3100-4T3150M	600	315
	ED3100-4T3500M	645	350
	ED3100-4T3750M	675	375
	ED3100-4T4000M	750	400
220V Single-phase	ED3100-2S0007M	5.0	0.75
	ED3100-2S0015M	7.5	1.5
	ED3100-2S0022M	10.0	2.2

Remarks: Inverter with other specification for 220V voltage can be produced according to customer's requirement.

2.2 Product Spec.

Item		Standard Spec.
Input	Rated Voltage、Frequency	Single-phase220V、Triphase220V、Triphase380V; 50Hz/60Hz
	Alternation allowance	Voltage: -20% ~ +20% Voltage out of balance rate: <3% Frequency: $\pm 5\%$
Output	Rated voltage	0~200V/0~380V
	Frequency range	0Hz~400Hz
	Overload Capacity	M Type: 150% 1MIN, 180% 1second, 200% instant protection; FP Type: 120% 1MIN, 150% 1second, 180% instant protection
Major control function	Modulation Method	Optimized SVPWM
	Control Mode	Speed Sensorless Vector Control
	Frequency Accuracy	Digital Setting: highest Frequency $\times \pm 0.01\%$; Simulation Setting: highest Frequency $\times \pm 0.2\%$
	Frequency Resolution	Digital Setting: 0.01Hz; Analog Setting: Max. Frequency $\times 0.1\%$
	Frequency of Starting	0.0Hz~10.00Hz

	Torque Boost	Auto torque boost, Manual torque boost 1%~30.0%(effective for V/F mode)
	V/F Curve	Linear V/F Curve、Square V/F Curve、User Defining V/F curve
	Acceleration /Deceleration time	Time Unit Option(Minute/Second), Max. value is 3600 (0.1~3600)
	DC Braking	Optional at start or stop, Operation Frequency 0~20Hz, Operation time could set 0~30second
	Jog	Jog frequency: 0.1Hz~50.00Hz, Job Accelerate and Decelerate time:0.1~3600seconds
	Built-in PID	Easy to form closed loop control system, and suitable for process control of pressure, flow rate and so on
	Multi-stage Operation	To achieve Multi-stage Operation by built-in PLC or control terminal
	textile transverse frequency	To achieve transverse operation with fixed amplitude or variable amplitude
	Automatic Voltage Regulation	When the grid voltage changes, the constant output of voltage can be ensured by adjusting the PWM output.
	Automatic Energy Saving Operation	To automatically optimize V/F curve according to the Load to achieve energy saving operation
	Automatic Current Restriction	To automatically restrict the current during operation to avoid frequent over current failure trip
Vector Control	Torque Characteristics	The output is 150% of rated torque at 1Hz. Stable speed accuracy is 0.1%

	Motor constant self identification	To achieve the best control effect, motor' s constant self identification can be fulfilled at motor' s complete halt.
Operation Function	Running Command Channel	Operation Panel Setting; Operation Terminal Setting; Serial Port Setting; any mode can be switched to the other model
	Frequency Setting Channel	Keyboard analog potentiometer setting; Keyboard ▲、▼ button setting; Functional Code Setting; Serial port setting; Terminal UP/DOWN Setting; Analog Voltage Setting; Analog current setting; Pulse Setting; Combination Setting
	Switch Input Channel	Forwarder/reverse Command; 6 Group Programming switch value input, 30 functions can be at most
	Simulation Input Channel	2-way analog signal input, 0~20mA and 0~10V are optional
	Analog Output Channel	Could select simulation output of 0~10V, 0~20mA, could achieve frequency setting, output frequency and other physical quantity output
	switch Output channel	3-way programming open circuit collector output; 1 way relay output signal, variable kinds of physical quantity output can be achieved.
Control Pannel	LED Digital Display	It can display setting frequency, input voltage, output current and other constants
	External meter Display	It can display output frequency, input current, output voltage and so on.
Protection Function		Over current protection; Over Pressure protection; Low-Voltage Protection; Over Heating Protection; Over-load Protection

Accessory Choosing		Braking Component; remote operator panel; Remote Cable; Keyboard Fitting Seat and so on
Environment	Where used	Indoor, keep away from direct sunshine, no dust, aggressive gas, oil mist, water vapor and so on
	Elevation	less than 1000meters (need to derate if beyond 1000meters)
	Environment Temp.	-10°C~+40°C
	Humidity	Less than 90%RH, non condensing
	Vibration	Less than 5.9 meters/second
	Storage Temp.	-20°C~+60°C
structure	Protection Class	IP20 (under the state of Operation or Keyboard Display)
	Cooling Method	Forced air cooling
Installation Method		Wall Mounting, Cabinet Installation

2.3 Inverter Exterior Description

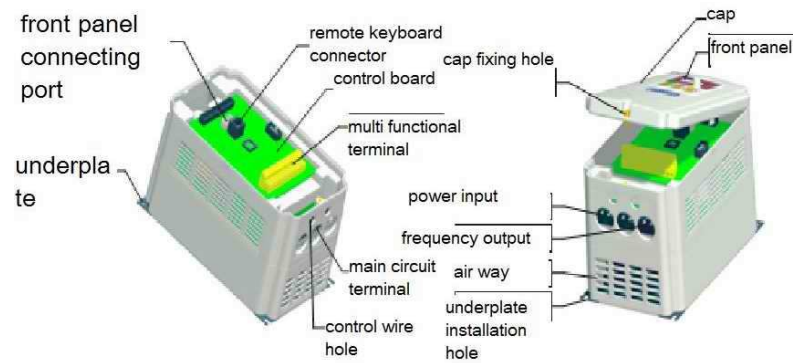

2.4 Exterior Dimensions

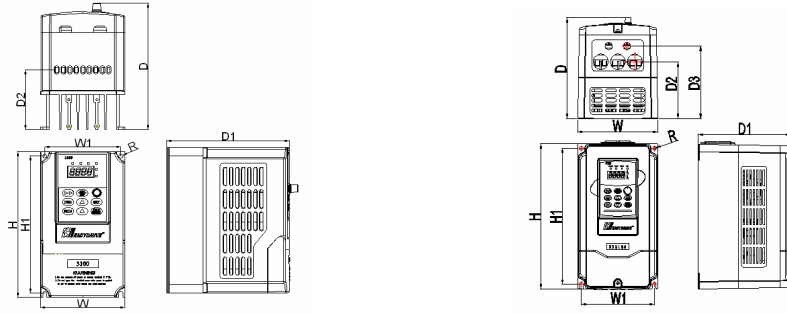

(a): 0.4KW~1.5KW SPEC.

(MINI Model)

(b): 0.75KW~4.0KW SPEC (Standard Model)

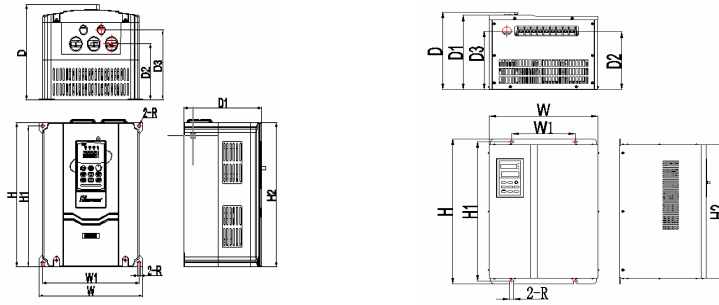

(c): 5.5KW、7.5KW SPEC.

(d): 11KW~30KW SPEC.

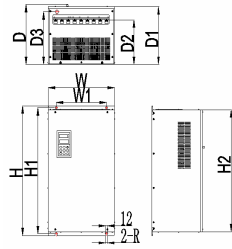

(e): 37KW~132KW SPEC.

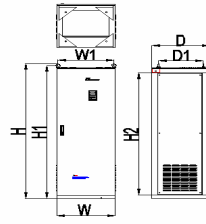

(f): 220KW~400KW SPEC.

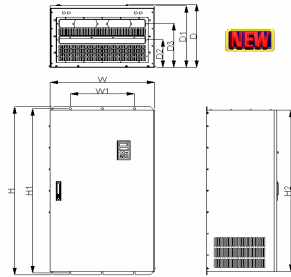

(g): 160KW~200KW Metal Shell (wall hanging)
Cabinet

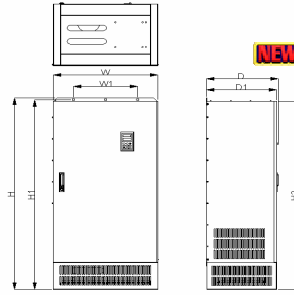

(h): 160KW~200KW Metal
Cabinet

Form 2-2 Exterior and Mounting Dimensions

SPEC.	W	W1	H	H1	H2	D	D1	D2	D3	R
ED3100-4T0007M /2S0007 (MINI Model)	98	88	175	165		152	142.3	72		2.5
ED3100-4T0015M /2S0015 (MINI Model)										
ED3100-4T0007M	132	120	232	218		162	152	92	117	2.5
ED3100-4T0015M										
ED3100-4T0022M										
ED3100-4T0040M										
ED3100-2S0007M										
ED3100-2S0015M										
ED3100-2S0022M										
ED3100-4T0055M	226	210	270	256.5	269	179	169	105	131	6.5
ED3100-4T0075M										
ED3100-4T0110M	247	186	350	334	312	232	222	160	190	4.5
ED3100-4T0150M										
ED3100-4T0185M										
ED3100-4T0220M	341	200	530	510	487	285	273	212	215	5.5
ED3100-4T0300M										
ED3100-4T0370M	368	230	600	580	557	281	271	219	223	5
ED3100-4T0450M										
ED3100-4T0550M	394	300	679	659	638	302	313	233	275	6
ED3100-4T0750M										
ED3100-4T0930M	533	420	825	797	772	368.6	357.5	192	324	6
ED3100-4T1100M										
ED3100-4T1320M										
Wall Hanging Installation	684	420	1250	1222	1200	470	460	207	327	6

ED3100-4T1600M									
ED3100-4T1850M									
ED3100-4T2000M									
Cabinet Installation (new)	684	420	1425	1411	1400	470	460		
ED3100-4T1600M									
ED3100-4T1850M									
ED3100-4T2000M									
ED3100-4T2200M									
ED3100-4T2500M	660	635	2038	2020	1936	600	575	Cabinet Installation	
ED3100-4T2800M									
ED3100-4T3150M									
ED3100-4T3500M	660	635	2038	2020	1936	600	575	Cabinet Installation	
ED3100-4T4000M									

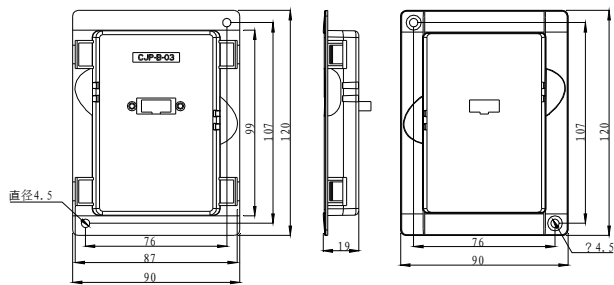

ED3100-LKD External lead splint Dimensions

(Accessory Choosing)

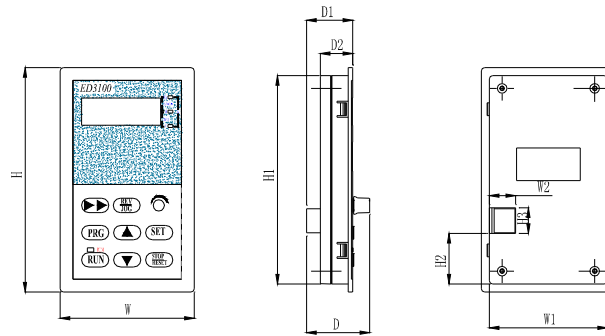

ED3100-RKD Remote Control Keyboard SPEC.
Form 2-3 ED3100 ED3100 remote control keyboard outline
and installation dimensions.

SPEC.	W	W1	W2	H	H1	H2	H3	D	D1	D2
ED3100 remote control	84	74	16.5	140	130	31.5	16	39.6	29	20.3

NOTES: The manufacturer reserve the rights to amend above Spec. without prior notification.

2.5 Optional Accessories: Please buy the below accessories from our company if needed.

2.5.1 Remote Control Keyboard

---- ED3100 use RS485 communication ways between the Inverter and the Remote Control Keyboard. Just need a 8 core network cable to connect, its ports just using RJ45, easy to install. The maximum electric distance could reach 500 meters.

Remote Control Keyboard could realize below function:

- (1) ----To control sub-machine running, stopping crawl, fault restoration, change setting frequency, change function constant and running direction.
- (2) ---To monitor sub-machine running frequency, setting frequency, output voltage, output current and other monitor constants.

2.5.2 Communication Cable

remote Control Keyboard communication cable

MODEL: ED3100-LAN0020 (2.0m)

1m、2m、5m、10m、20m is our inverter' s standard configuration, need

to order to make for above 20m.

It is used for communication between remote control keyboard and the inverter.

2.5.3 Braking Resistor

ED3100 series Inverters braking unit is accessories, in need it, please make description when place order. Energy consuming braking resistor please selecting according to Form 2-4. Connection installation is shown as 2-1.

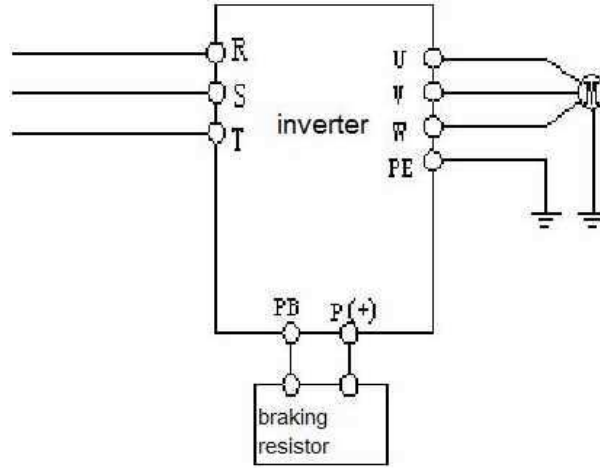



Fig. 2-1 Connection Diagram between Inverter and Braking unit (under 380V 18.5KW)

Form 2-4 Braking Resistor Selection Form

SPEC	Applicable Motor Power (KW)	Resistor Value (ohm)	Resistor Power (W)
ED3100-4T0007MB	0.75	300	100
ED3100-4T0015MB	1.5	300	200
ED3100-4T0022MB	2.2	200	200

ED3100-4T0040MB	4.0	150	400
ED3100-4T0055MB	5.5	100	500
ED3100-4T0075MB	7.5	75	800
ED3100-4T0110MB	11	60	1000
ED3100-4T0150MB	15	45	1500
ED3100-4T0185MB	18.5	40	2000

- 
- 1、 --- Standard product do not include built-in braking unit. If need , please remark it when ordering.
 - 2、 --For those model beyond ED3100-4T0185M need exterior braking unit. (please consult the manufacturer)
 - 3、 --- The cable length of the braking resistor should less than 5M. The braking resistor will cause temperature rising during energy consuming, so should pay attention to safety protection and good ventilation during installation.

Chapter 3 The Inverter Installation and Wiring

3.1 The Inverter's installation environment

3.1.1 Installation environment requirements

- (1) Install the inverter in a location with good ventilation, the temperature should be within $-10^{\circ}\text{C}\sim 40^{\circ}\text{C}$, if the temperature exceeds 40°C , external forced cooling or derating use of inverter is required.
- (2) Install the inverter in a location free from direct sunlight, dust, floating fiber and metal powder.
- (3) Install the Inverter in a location free from corrosive and explosive gas.
- (4) Humidity should be less than 95%RH, free from condense.
- (5) Install the inverter on plane surface where the vibration is less than 5.9 meters/second²
- (6) Keep the inverter away from electromagnetic interfering source and other electronic devices which is electromagnetic disturbance sensitive

3.1.2 Installation Orientation and Space.

- (1) Normally the inverter should be installed vertically.
- (2) The installation interval and minimum distance requirements is shown in fig. 3-1.
- (3) If several inverters needs stack installation, guide plate needs to be put between each two inverters, as shown in Fig 3-2.

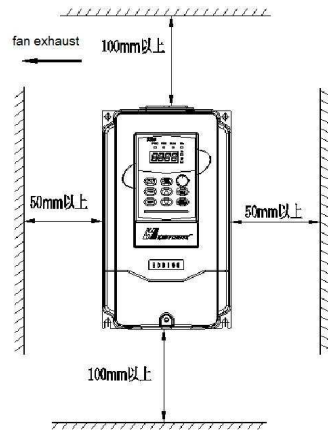

Diagram 3-1 Installation Gap

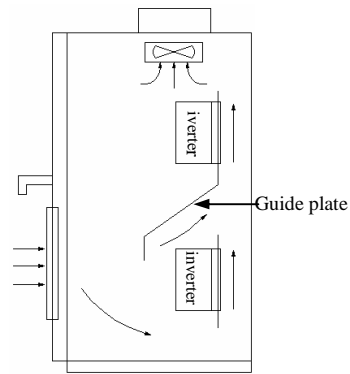

Diagram 3-2 Multi-Inverter Installation Instruction

3.2 Removal/installation of the Front Cover of the Inverter

Removing: Use Cross Screwdriver to discharge the front cover fixing screw to remove the front cover

Install: To align the fixing screw hole and get the screw assembled.

3.3 Wiring Precautions.



- (1) ---Be sure to cut the power supply above 10 minutes before wiring, otherwise , an electric shock can occur.
- (2) ---Do not connect AC power to output terminal U, V, W.
- (3) ---- When leakage current exists in inverter, for safety inverter and motor should be grounded. The grounding cable is copper wire with diameter above 3.5mm^2 , and the grounding resistor should be less than $10\ \Omega$.
- (4) ----The Inverter had already pass through voltage withstand tests, so the end users shall not perform it again.
- (5) ---- Electromagnetic contactor and absorbing capacitor unit were not allowed to be added between the inverter and the motor, as illustrated in fig. 3-3.
- (6) ---- For convenience of overcurrent protection and power failure maintenance, the Inverter should be connected with power supply by middle current braker.
- (7) ---- Wiring of input and output circuit (DI1-DI6, DO1, DO2, DO3), should use bunch wire or shielded wire with diameter above 0.75mm^2 , one side of the wire hovering, the other side connect with E Terminal of the Inverter, the connection cable should less than 50m.

**WARNING**

- (1) ---- To make sure to cut off the power supply and all the LED indicator lamps go out, and then wait for above 10mins before wiring.
- (2) ----To make sure that the DC voltage of the Inverter's main circuit between Terminal P + and Terminal P- falls to DC36V before external wiring.
- (3) ----Wiring must be performed by an trained and authorized qualified professional staff.
- (4) ---- Check to be sure that the voltage of the main AC power supply meets the

rated voltage of the Inverter. Otherwise could result in personnel injury and equipment broken.

3.4 Wiring Main Circuit Terminals

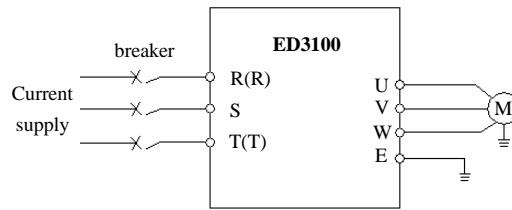

Fig 3-3 Main circuit simple wiring

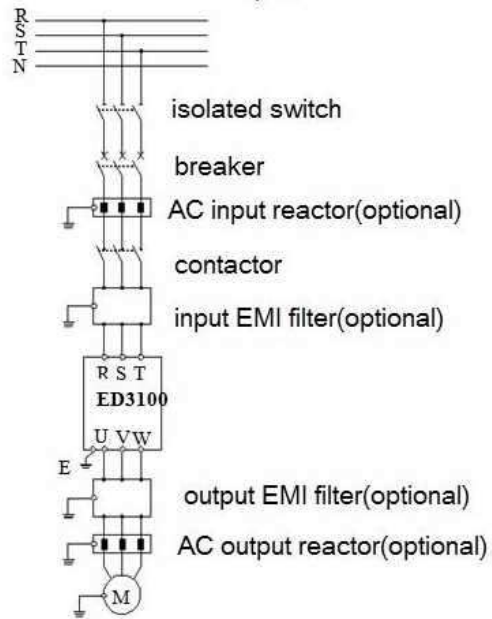

Fig. 3-4 The connection between inverter and optional components.**3.4.1 Connection between the Inverter and the Accessories.**

- (1) -Install isolating switch and other braking unit between the Inverter and grid supply and inverter for personnel safety and forced power cut.
- 2) ---- There must be overcurrent protection fuse and circuit Breaker installed in the power supply circuit to avoid failure range extension.
- (3) AC Input Reactor
---- when power supply network is not so good, should install AC Input Reactor as it could improve input power factor.
- (4) Contactor is only used for power supply control.
- (5) ---at the input side of EMI filter, EMI filter is optional to restrain the high frequency conductive emission and RF interference generated by the power cord of the inverter.
- (6)-- At the output side of EMI filter, EMI filter is optional to restrain RF interfering noise generated and current leakage of cord..
- (7) AC Output Reactor

If the connection cable between the inverter and the motor exceeds 50m, you are suggested to install AC output reactor to lessen leakage current and improve motor lifetime. In the course of installation, AC output reactor' s pressure drop needs to be considered. Or you need to use the inverter with higher input and output, or the motor' s use needs to be derated, otherwise, the motor could be burned.

(8) Safety Grounding

There is leakage current in inverter, for safety, the inverter and the motor should be grounded separately, the grounding resistor should be less than 10Ω. The grounding cable should be as short as possible, the diameter should conform to the standard of Form 3-1. (The data are correct



only when the 2 conductor use the same metal. If not, protective conductor' s sectional area should be got by the method of equivalent conductivity. As shown in Form 3-1.)

Form 3-1 sectional area of protective conductor

Conductor Sectional Area S (mm ²)	Ground Conductor Minimum Sectional Area S (mm ²)
$S \leq 16$	S
$16 < S \leq 35$	16
$35 < S$	S/2

3.4.2 Main Circuit Wiring

(1) Main Circuit Input and Output Terminals shown as form 3-2.

FIT Models	Main Circuit Terminals	Terminal Name	Function Description
ED3100-4T0007M- ED3100-4T0040M	 P- P+ PB R S T U V W E	R, S, T	Three phase current 380V Input Terminal
		U, V, W	Three phase output terminal
		P+, PB	braking resistor connection terminal
ED3100-4T0055M- ED3100-4T0075M	 R S T P- P+ PB U V W E	R, S, T	Three phase current 380V Input Terminal
		U, V, W	Three phase output terminal
		P+, PB	braking resistor connection terminal
ED3100-4T0110M- ED3100-4T0185M	 P+ P- R S T U V W PB E	R, S, T	Three phase current 380V Input Terminal
		U, V, W	Three phase output terminal
		P+, PB	braking resistor connection terminal
		E	ground terminal

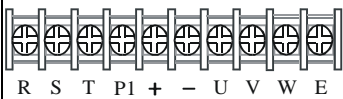
ED3100-4T0220M- ED3100-4T4000M		R, S, T	Three phase current 380V Input Terminal
		U, V, W	Three phase output terminal
		E	ground terminal

(2)、 Form 3-3 Main Circuit Cable diameter, incoming line protective circuit breaker QF or Resistor model as below:

MODEL	Breaker (A)	Fuse (A)	Input Line (mm ²)	Output Line (mm ²)	Control Line (mm ²)
ED3100-2S0007M	10	10	1.5	1.5	1
ED3100-2S0015M	10	10	1.5	1.5	1
ED3100-2S0022M	16	10	2.5	2.5	1
ED3100-4T0007M	10	10	1.5	1.5	1
ED3100-4T0015M	10	10	1.5	1.5	1
ED3100-4T0022M	16	10	2.5	2.5	1
ED3100-4T0040M	20	16	2.5	2.5	1
ED3100-4T0055M	32	20	4	4	1
ED3100-4T0075M	40	32	6	6	1
ED3100-4T0110M	63	35	6	6	1
ED3100-4T0150M	63	50	6	6	1
ED3100-4T0185M	100	63	10	10	1
ED3100-4T0220M	100	80	16	16	1
ED3100-4T0300M	125	100	25	25	1
ED3100-4T0370M	160	125	25	25	1
ED3100-4T0450M	200	160	35	35	1
ED3100-4T0550M	200	160	35	35	1

ED3100-4T0750M	250	200	70	70	1
ED3100-4T0930M	315	250	70	70	1
ED3100-4T1100M	400	315	95	95	1
ED3100-4T1320M	400	400	150	150	1
ED3100-4T1600M	630	450	185	185	1
ED3100-4T1850M	630	500	185	185	1
ED3100-4T2000M	630	560	240	240	1
ED3100-4T2200M	800	630	150×2	150×2	1
ED3100-4T2500M	800	630	150×2	150×2	1
ED3100-4T2800M	1000	800	185×2	185×2	1
ED3100-4T3150M	1200	1000	240×2	240×2	1

(3) Input AC Reactor, Output AC Reactor Specification.

Inverter Capacity (KW)	Input AC Reactor		Output AC Reactor	
	Current (A)	Current (mH)	Current (A)	Inductor (uH)
ED3100-4T0370M	60	0.24	63	0.86
ED3100-4T0450M	75	0.235	80	0.70
ED3100-4T0550M	91	0.17	100	0.58
ED3100-4T0750M	112	0.16	125	0.47
ED3100-4T0930M	150	0.12	160	0.35
ED3100-4T1100M	180	0.10	200	0.29
ED3100-4T1320M	220	0.09	224	0.24
ED3100-4T1600M	265	0.08	280	0.215
ED3100-4T1850M	300	0.07	315	0.177
ED3100-4T2000M	360	0.06	400	0.142
ED3100-4T2200M	400	0.05	560	0.126

ED3100-4T2500M	560	0.03	600	0.10
ED3100-4T2800M	640	0.0215	630	0.08

3.5 Basic Running Wiring Diagram

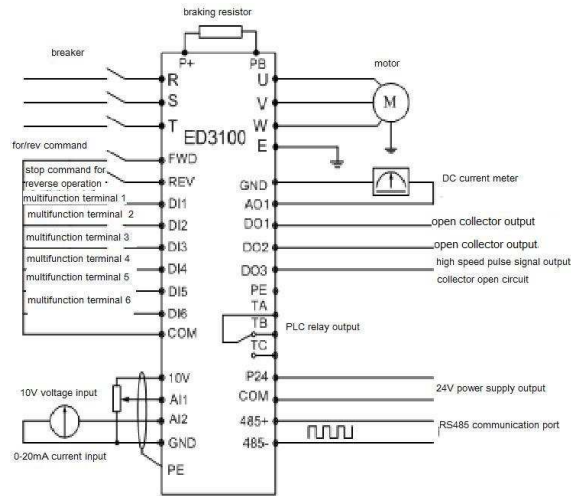
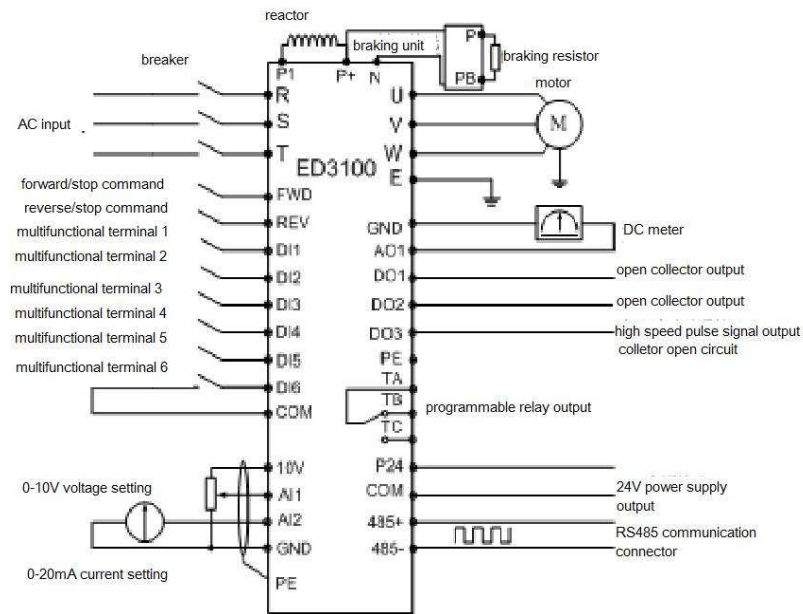

Fig.3-5 Basic Running Wiring Diagram

FIT MODEL :ED3100-4T0007M~ED3100-4T0185M

Note:

1. ---AI2 could select voltage or current signal input, switched by JP1 on the control panel.
2. ---AO1 could select Output voltage or current signal, switch by the JP1 on the control panel.
3. --- DI6 Terminal can distinguish high speed pulse signal, DO3 can generate high speed pulse signal, but they are non-standard function, special description needs to be given when ordering.



Form3-6 Basic Running Wiring Diagram FIT MODELS: ED3100-4T0220M~
ED3100-4T4000M

Remarks:

1. --AI2 is used to select voltage or current signal input, switched by the JP1 on the control panel.
2. ---A01 is used to select Output voltage or current signal, switch by the JP1 on the control panel.
3. DI6 Terminal is used to distinguish high speed pulse signal, D03 could generate high speed pulse signal, but they are non-standard function, should make special description during ordering.

3. 6 Control Circuit Configuration and Wiring

3. 6. 1 Control Circuit Terminal CN3, arrangement as below:

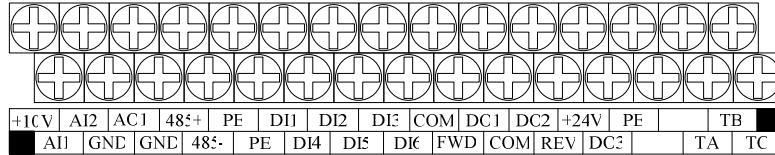

Form 3-7 Control Panel Terminal Arrangement Order Diagram

3. 6. 2 CN3 Terminal Function description, shown as 3-4

TYPE	Terminal NO.	NAME	Terminal Function Description
Communication	485+	RS485 Communication Port	RS485 Differential Signal Positive Terminal
	485-		RS485 Differential Signal Negative Terminal
Multifunction Output Terminal	D01 D02	Open collector Output Terminal	Programmed multifunction switch terminal. Please see in Terminal Function It can be defined as multifunctional switch value terminals by programming. Please see the output function introduction if constant P4.07, P4.08. terminal: COM)
	D03	high speed photocoupler	It outputs signal of 0-20KHz for output frequency, output motor speed, output voltage, etc. (please see details
Relay Output Terminal	TA, T B, TC	programmable relay terminal output	Command: TA-TB, normally closed; TA-TC normally open. When TA-TB is kept open/TA-TC is kept closed (please see details
analog value input	AI1	analog value input AI1	To accept analog voltage value input (reference ground)
	AI2	Analog value input AI2	to accept analog current, voltage value input. (ground: GND) please refer to fig. 3-9 to select the DIP switch JP1 on the left of control

analog value output	A01	analog value output A01	To provide analog voltage value output which correspond of physical quantity. Output frequency is factor (reference ground :GND)	
operation control terminal	FWD	forward operation command	forward and reverse operation switch value command	DI1~DI5 FWD、REV
	REV	reverse operation command		
multi function Input Terminal	DI1	Multi function Input Terminal 1	they can be defined as multifunctional switch value input by programming. Please see the input terminal function of terminal function constants in chapter 6. (common terminal)	COM
	DI2	Multi function Input Terminal 2		
	DI3	Multi function Input Terminal 3		
	DI4	Multi function Input Terminal 4		
	DI5	Multi function Input Terminal 5		
	DI6	Multifunction Input Terminal6	could be used as pulse signal input port	
Power	10V	+10V power	externally supply +10V power(negative pole terminal);	
	GND	+10V power common port	analog signal and +10V power reference ground	
	COM	+24V power common port	Digital signal input, Output common port	
	+24V	+24V voltage	Digital Signal Power	

Table 3-4 Control Panel CN3 Terminal Function Form**3.6.3 Simulation Input and Output Terminal Wiring**

(1) AI1 Terminal accept simulation voltage signal input, connection as below:

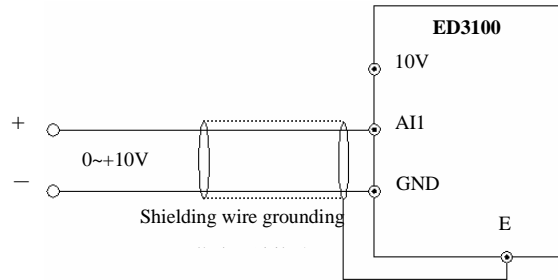
**Fig.3-8 AI1 Terminal wiring**

(2) AI2 Terminal accept Simulation Voltage, Current Signal input wiring means as below:

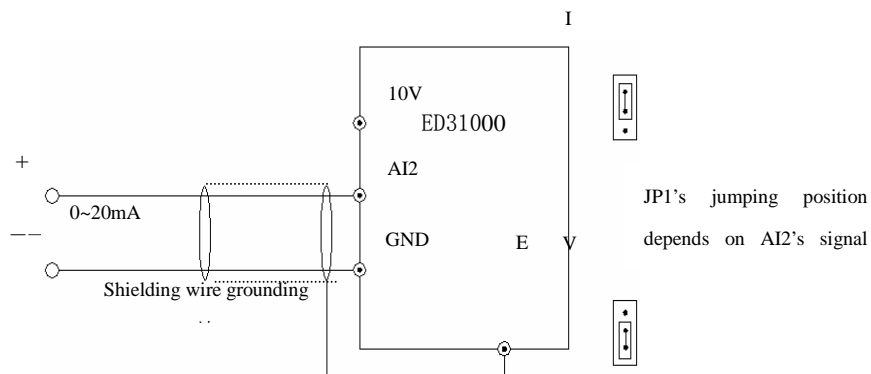
**Fig. 3-9 AI2 terminal wiring**

(3) Simulation Output Terminal A01 Wiring

Simulation Output Terminal A01 External connected meter could show

various physical quantity, terminal wiring diagram as Drawing 3-10

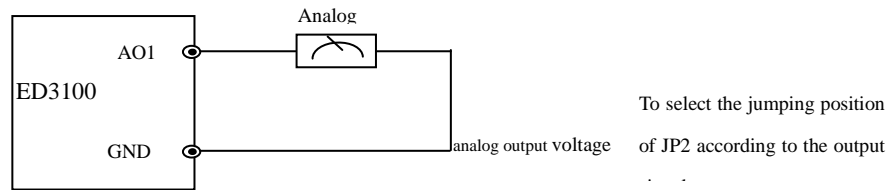

Fig. 3-10 Simulation Output Terminal Wiring

Remarks: Simulation input, output signal are easy to be interfered, so need to use shielded cable for wiring, well ground, and the wiring cable should be as short as possible.

3.6.4 Communication Wiring

The communication interface provided by ED3100 inverter is Standard RS485 communication.

- (1) Use RS485 interface to connect Remote Control Keyboard and the Inverter, just plug the Remote Control Keyboard directly to the communication port of RS485, and take away the Inverter's Keyboard as the Inverter's Keyboard and Remote Control. Keyboard could work together.
- (2) The Inverter's RS485 interface connect with the computer.

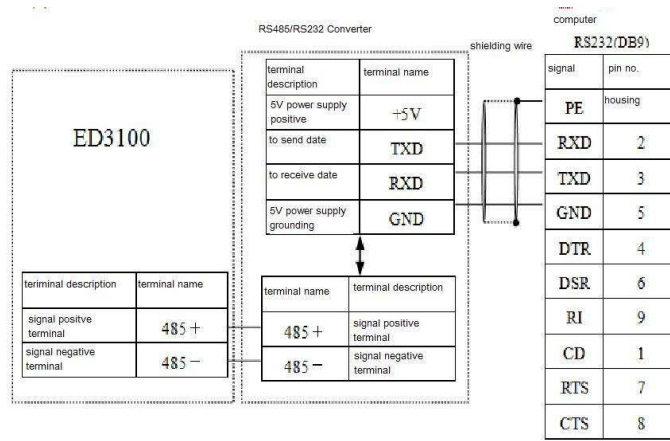

Form 3-11 RS485—(RS485/232)—RS232 Communication Wiring

- (3) ---Multi-Inverter could be connected by RS485, PLC(or WINCC) as Host control, just show as 3-12, or could let one of the Inverter as Host Unit, other Inverters as slave, just shown as 3-13. With connected unit increased, the communication system will be easily interfered, suggest to do wiring as below:
- (4)

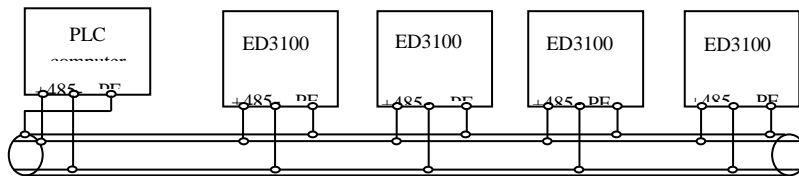

Form 3-12 Wiring Diagram of communication between PLC and the

Inverter(The Inverter and Motor are well ground.)

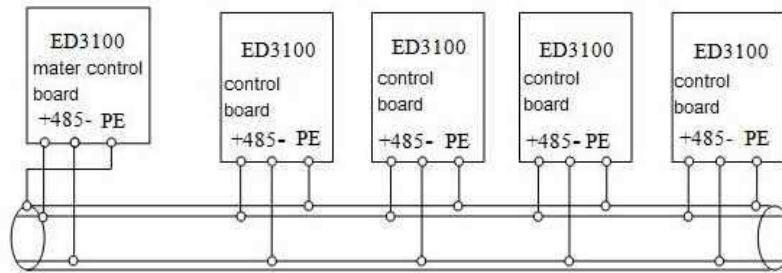

Form 3-13 Wiring Diagram of the Inverter communication(The Inverter and the Motor should be well grounded)

If the above wiring doesn't result in normal communication, the following method can be tried:

- (1) --- To power on PLC separately or to isolate its power supply
- (2) ---To use magnetic ring on the communication line, to lower down the Inverter's carrier frequency.

3.7 Conform to EMC Installation Instruction.

----The Inverter' s output is PWM curve, will generate certain electromagnetic noise during operation. In order to reduce interference to the outer world, this chapter just introduce Inverter' s EMC installation means by noise suppression, field wiring, grounding, leakage current, current filter usage.

3.7.1 Noise Suppression

(1) Noise type

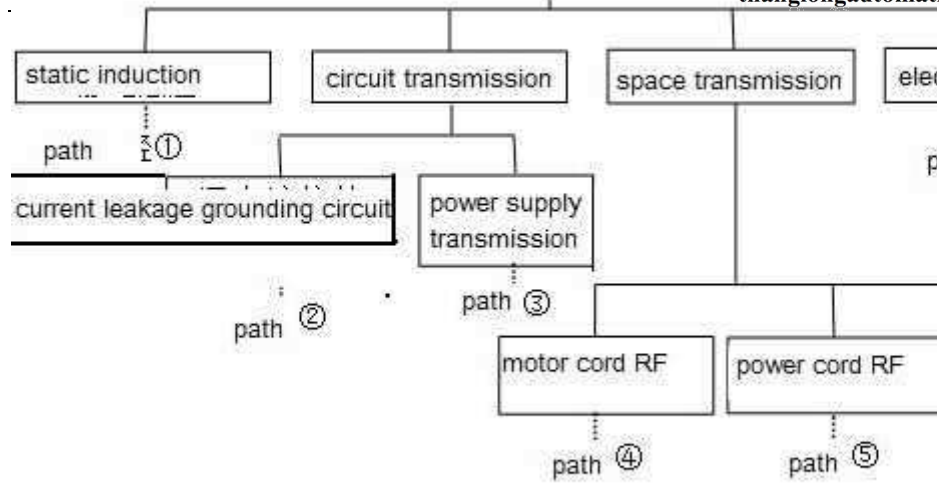

(2) Measures of Noise Control

Tabel 2-5 Measures of Noise Control

Noise Transmit Route	Measures
②	When the ground wire of external devices and inverter wiring has close loop circuit, it will cause leakage current of inverter ground wire and then makes devices malfunction. If devices are not grounded, it will decrease malfunction.
③	When external devices and inverter work in the same power system, inverter noise will transmit through power wires and cause interferences to other devices. Countermeasures include: install electromagnetic noise filter in inverter input terminal; install isolation transformator to other devices or power supply filter.
④⑤⑥	(1) Easy interferenced devices and signal wires should be installed away from inverter. Signal wire should be shielded wire, shielded layer should be single-end grounded and be far away from the wire entrance of inverter. If interlacement of signal wire and power cable, it is suggested to apply perpendicular through wiring. (2) When install motor filter at the end of inverter output and input wires, it will lower RF interference of power supply effectively.

	(3) Motor power cable should be wired in thick shield, such as more than 2mm cube or cement cabinet. Power supply wire should be put in metallic cube and shielded wire be grounded. (Motor power cable uses four-core cable, whose one circuit terminal is grounded in the wire entrance of inverter, while the other terminal is connected to motor casing.)
①⑦⑧	Do not arrange light current wires and strong current cables in parallel or tie together; They shall be far away from inverter installation equipment, wiring should be away from inverter input or output wires. Signal wire shall be shielded wire. Devices with strong current or strong electromagnetic field should be installed away from inverter. A suitable distance or perpendicular place is suggested.

3.7.2 Site Wiring and Ground S27—270

(1) When wiring, cables from inverter to motor, namely U、V、W terminals of AC output and power supply cables R、S、T or R、T terminals of AC input should be arranged in different area. It is strictly prohibitive to arrange them in parallel or interlacement at a close distance (less than 30cm) or tie them together.

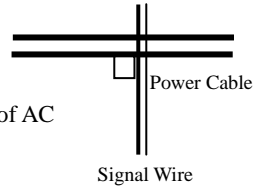

Figure 3-14 System Wiring

- (2) U、V、W Terminals of AC output is recommended to be installed in a metallic cube or metallic cabinet.
- (3) Use shielded cables to connect control terminals. Connect the ground terminal (PE) with shield wire layer and single-end ground it near the wire entrance of inverter.
- (4) Do not use ground wire of other devices as inverter terminal PE. PE must be connected with ground directly.
- (5) It is strictly prohibitive to arrange signal wire(light current) and power supply cable(strong current, namely R、S、T or R、T and U、V、W terminals)in parallel or tie them together. They must keep away at a distance of 20~60 centimeters according to strong current. If interlacement, it is suggested to apply perpendicular through wiring (please refer to Figure 3-14).
- (6) Light current wires such as signal wire and sensor wire and strong current cables must be separately grounded.
- (7) Do not connect input terminals R,S,T or R,T to other devices.



Chapter 4 Running and Operating

4.1 Running of inverter

4.1.1 Running order channels

ED3000 inverter has 3 kinds of order channels for controlling running operation such as start, stop, jog, etc.

Operation Panel

Control by keys , ,  on keyboard to start or stop the motor.

Control terminal

Use control terminal FWD, REV, COM to make double-line control, or use one of the terminals of DI1~DI6 and two terminals FWD and REV to make 3-line control.



Serial Port

Control start or stop of the inverter through upper machine or other devices which can communicate with the inverter.

Choose order channel by setting function code P004.

4.1.2 Frequency-provision channels

Under common running mode, PR6000 series inverter has 9 kinds of provision channels:

- 0: keyboard analogy POT provision
- 1: Digital setting 1 keyboard ,  provision
- 2: Digital setting 2 terminal UP/DOWN provision
- 3: Digital setting 3 Serial Port provision
- 3: Analog voltage signal AI1 (0-10V) provision
- 4: Analog current signal AI2 (0-20mA) provision
- 6: Terminal pulse (0-10KHZ) provision
- 7: Combination provision
- 8: External terminal choice provision

4.1.3 Work State

Work states of ED3100 are classified as Stop State, Run State, Programming State and Failure Alarm State:

Stop State:

If there is no running command after the inverter electrified or after stop command during running state, the inverter enters into waiting state

Running State:

Received run command, the inverter enters into running state

Programming state:

By operating keyboard, modify and set the function parameters of the inverter

Failure Alarm State:

Malfunctions caused in external devices or the inverter or operation errors; the inverter shows relevant malfunctions codes and block outputs.

4.1.4 Run mode

ED3100 inverter has five run modes, following is in turn according to their priorities, they are: jog run→closed-loop run→PLC run→multi-speed run→common run. Shown as diagram 4-1

0: Jog run

Upon receiving jog run command(for instance, press the  key on keyboard)during stopping state, the inverter runs at jog frequency(see function code P052~P054).

1: Closed-loop run

The inverter will come into closed-loop run mode when closed-loop run control effective parameter is set P128. Namely carry on PID adjustment to specified value and feedback value and PID adjustor output is inverter output frequency.

2: PLC run

The inverter enters into PLC run mode and runs according to preset through setting PLC effective parameter (P085=1). PLC run mode can be paused by multi-function terminal (function 12).

3: Multi-speed run

By nonzero combination of multi-function terminal (function 1, 2, 3), choose multi-frequency 1~7(P086~P092) to run at multi-speed speed

4: Common run

Simple Sensor-Less run mode of general inverter.

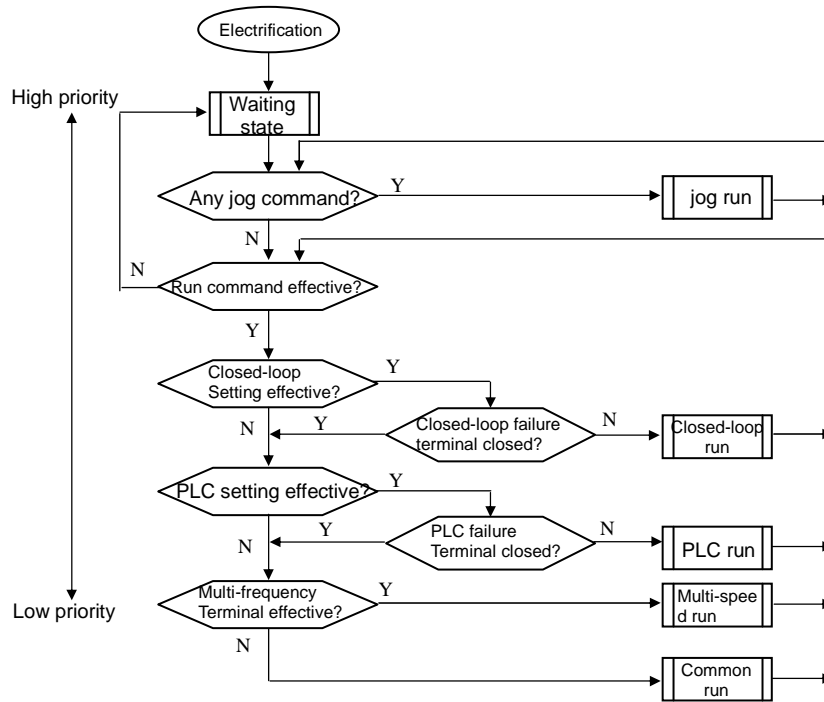

Diagram 4-1 Logic flow chart of PR6000 inverter run state

4.2 Operating and using of keyboard

4.2.1 Keyboard layout

Operating panel and control terminals can control the motor to run, change speed, stop, brake, set the run parameters and external devices. Operating panel is shown as diagram 4-3 and remote-control keyboard is shown as diagram 4-2.

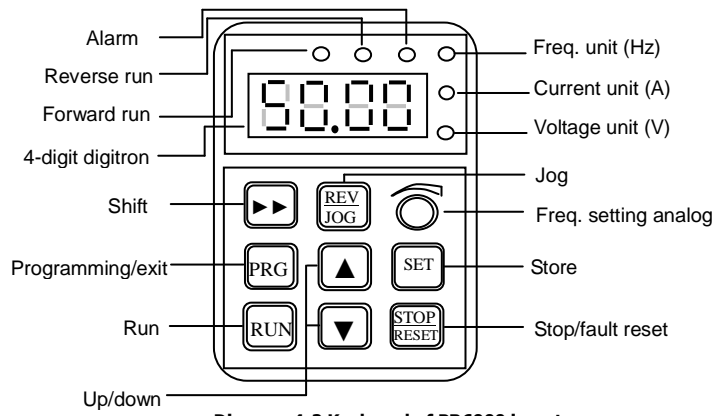

Diagram 4-2 Keyboard of PR6000 inverter

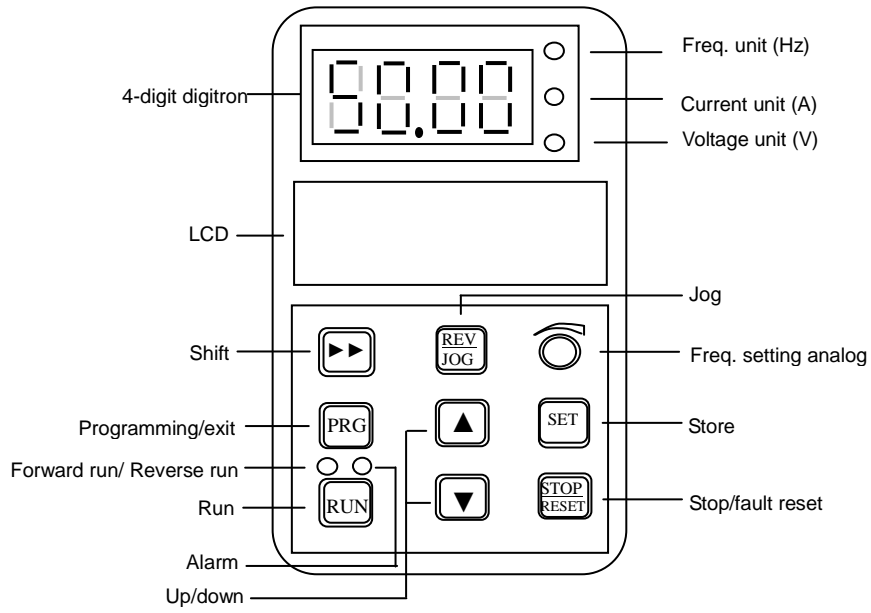

Diagram 4-3 Remote-control keyboard

4. 2. 2 Keyboard function description

here are eight buttons and one keyboard analog POT on the inverter keyboard, they functions are defined as Table4-1.

	Item	Function Description
State instructions help	Hz	The indicator light When the LED display content for frequency
	A	The indicator light When the LED display content for current
	V	The indicator light When the LED display content for voltage
	ALM	The indicator light When Current ,voltage limit
	FWD	The indicator light When inverter in a fwd. operation
	REV	The indicator light When inverter in a rev. operation
	Hz&A	The two bright lights When the LED display content for Speed
	Hz&V	The two bright lights When the LED display content for Percen.
	A&V	The two bright lights When the LED display content for
	Hz&A&V	The three bright lights When the LED display content for
Key function	RUN	Run key: Enter into run mode under keyboard mode.
	REV/JOG	Jog/ Reverse key: Jog or Reverse run is available when pressing this key under keyboard mode.
	STOP/RESET	Stop/Reset key: In common run status the inverter will stop according to set mode after this key is pressed if run command channel is set as panel effective mode. The inverter will reset and resume normal stop status after this key is pressed when the inverter is in malfunction
	PRG	Program key: Enter into or exit Program/Monitor status
	SET	Data/store key: Enter into next level menu or store function code when the inverter is in programming status.

▲/▼	Up/down data: Data or function codes increase or decrease
▶▶	Shift/Monitor key: Choose the digit of the data which is to be set and modified when the inverter is in edition status; switch monitor parameter to be shown when the inverter is in other statuses.

Table 4-1

Method for using panel

Can carry on various operations to the inverter through operating panel, for example:

- **Status parameter display switching:**

Pressing key ▶▶ display b group status supervision parameter. Method for switching is shown as diagram 4-7:

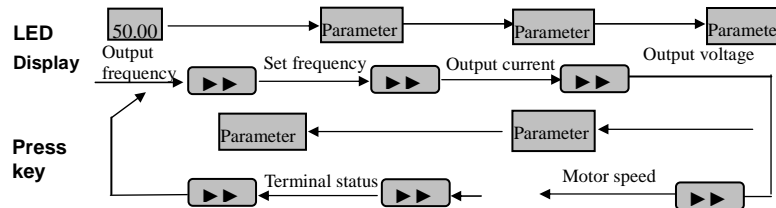

Diagram 4-7 Example of Run status parameter display operating

- (1) Only b000~b012 status parameters can be displayed when shipping out the inverter.
- (2) Pressing **SET** key to switch into defaulting supervision display status directly when the user see about status supervision parameter. Defaulting supervision parameter in stop status is set frequency and in run status, it is output frequency.

- **Setting of function code parameter**

Take function code P052 modified from 5.00Hz to 8.50Hz as example.

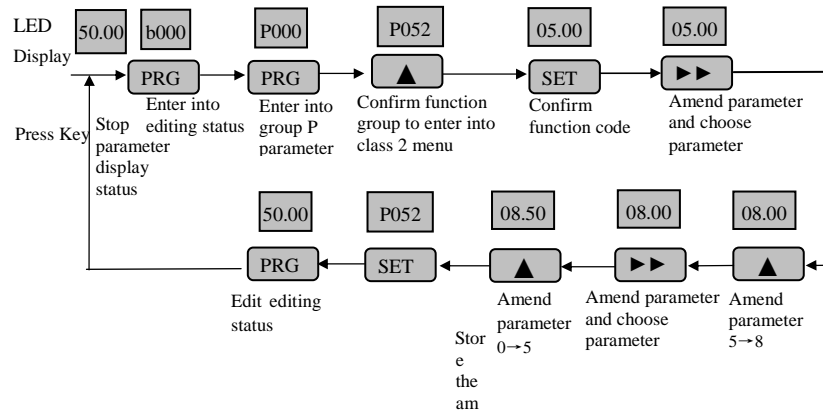

Diagram 4-8 Example of editing parameter operation

Description: under menu status, if the parameter has no flashing digit, this function code can not be modified, possible reasons are as follows:

- (1) This function code is the parameter that is not amendable, for example, actual detected status parameter, run record parameter etc.;
- (2) This function code can not be modified under run status and can be changed after stopping running
- (3) When parameter is protected, all the function codes can not be modified.

● Jog run operation

Assumed keyboard as current run command channel, jog run frequency 5Hz, in stop status, the example as follows:

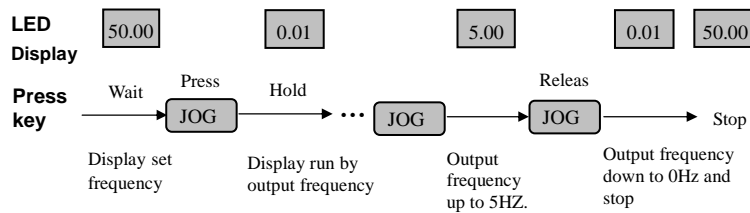

Diagram 4-9 Example of jog run operation

● Run, stop and forward/reverse switching

Assumed keyboard as current run command channel, specified frequency 20.00Hz, forward run, in waiting status, the example as follows:

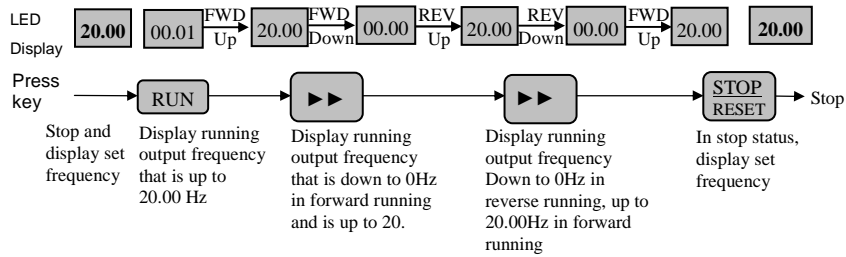

Diagram 4-10 Example of jog run operation

● Specified frequency keyboard ▲, ▼ key providing operation

Assumed current status is stop parameter stop status (P004=1), the operation as follow:

- (1) Frequency adjustment is provided with integral way;
- (2) Pressing ▲ key not release, the lowest digit increase at first; if the tens digit carries on, tens digit increase; if the hundreds digit carries on, hundreds digit increase.... Pressing ▲ the ▲ key again after the key is released, value increases from lowest digit again.
- (3) Pressing ▼ key not release, the lowest digit decrease at first; if the tens digit carries on, tens digit decrease; if the hundreds digit carries on, hundreds digit decrease.... Pressing the ▼ key again after the key is released, value decreases from lowest digit again.

4.3 Inverter electrification

4.3.1 Check before electrification

Please carry on wiring based on operation requirement provided in "Inverter wiring" of this manual.

4.3.2 Initial electrification

Close input side AC power supply switch after correct wiring and power supply confirmed, electrify the inverter and keyboard LED display starting status, contactor closes normally, and LED displaying set frequency shows that electrification is finished. First electrification operation process is shown as diagram 4-4.

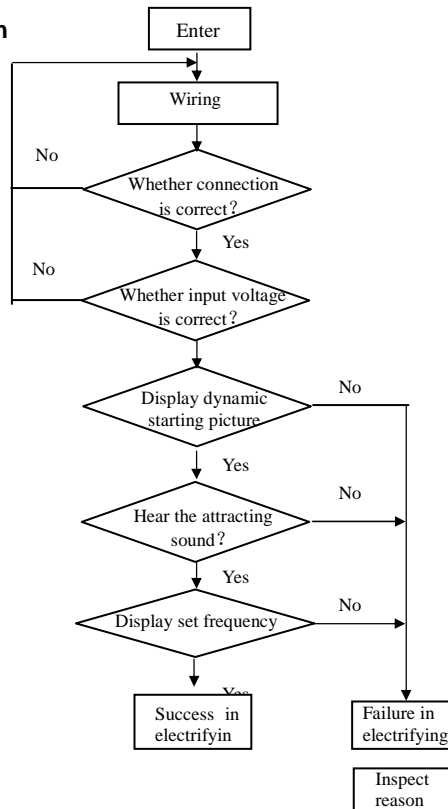

Diagram 4-4 Flow chart of inverter initially electrified operation

Chapter 5 Function parameter table

5.1 Introduction of symbol

@—Parameter function is non-standard option one;

×—Parameter can not be changed in process of running;

√—Parameter can be changed in process of running;

5.2 Function parameter table:

Basic parameters					
Function Code	Name & Definition	Set Range	Minimum Unit	Factory Default	Modification
P0.00	Control mode	0: Sensor-Less vector control (SVC) 1: V/F control	1	1	×
P0.01	Frequency input channel selection	0: Panel analog potentiometer setting 1: Keyboard digit setting 1 2: UP/DOWN terminal digit setting 2 3: Digital setting 3 Serial Port provision 4: AI1 analog voltage signal setting (0~10V) 5: AI1 analog current signal setting (0~20mA) 6: Terminal pulse(0~10.0k) 7: Combination provision 8: External terminal choice provision	1	1	○
P0.02	Load motor rated current	0.1A~999A	1	00	○
P0.03	Freq. digit setting	0.0Hz ~ Upper limit freq.	0.01Hz	50.00Hz	○

P0.04	Running command selection	0: Available keyboard run control 1: Available external terminal run command control 2: Available serial port run command control	1	0	○
P0.05	Run direction setting	0: Identical with the setting direction 1: Opposite to setting direction 2: Prevent reversing	1	0	○
P0.06	Upper limit freq.	{ P0.07, 0.10Hz } ~ 400.00Hz	0.01Hz	50.00Hz	×
P0.07	Lower limit freq	0.00 ~ 【P0.06】	0.01Hz	00.00Hz	×
P0.08	Basic operating frequency	1.0Hz ~ Upper limit freq.	0.01Hz	50.00Hz	×
P0.09	Maximum output voltage	200~500V 100~250V	1	380V 220V	×
P0.10	Model Select	0: M-(constant torque load models) 1: FP-(Fans, pumps class load models)	1	0	×
P0.11	Torque upgrade option	0: Manual 1: Automatic	1	0	×
P0.12	Torque upgrade set	0.0 to 30.0% Note: only when the force at the time of F0.11 = 0	0.1	Model Setting	○
P0.13	Slip frequency compensation	0.0~150.0%	0.1	0.0	○
P0.14	Acceleration time1	0.1 ~ 3600 Note: The default units seconds; acceleration and deceleration time units chosen see P3.09	0.1	Model Setting	○
P0.15	Deceleration time1		0.1	Model Setting	○
P0.16	V/F curve setting	0: Constant Torque 1: down torque curve1(1.7 power) 2: down torque curve2 (2.0 power) 3: Users set V / F curve (from P0.17 ~ P0.22 identified)	1	0	×
P0.17	V/F freq.value F1	0.00~Frequencies F2	0.01Hz	12.50Hz	×
P0.18	V/F volt. value V1	0.0~Voltages V2	0.1%	25.0%	×

P0.19	V/F freq.value F2	Frequencies F1~Frequencies F3	0.01Hz	25.00Hz	×
P0.20	V/F volt. value V2	Voltages V1~Voltages V3	0.1%	50.0%	×
P0.21	V/F freq.value F3	Frequencies F2~Basic operating frequency	0.01Hz	37.50Hz	×
P0.22	V/F volt. value V3	Voltages V2~100.0%	0.1%	75.0%	×
P0.23	REV/JOG key function setting	0: REV 1: JOG	1	1	○
Basic parameter					
Function Code	Name & Definition	Set Range	Minimum Unit	Factory Default	Modification
1.00	Load motor rated voltage	380V: 200~500V 220V: 100~250V	1V	380V 220V	○
P1.01	Load motor rated current	0.1~500.0A	0.1A	Model Setting	○
P1.02	Load motor rated speed	300~3000RPM	1RPM	Model Setting	×
P1.03	Load motor rated frequency	1.00~400.00Hz	0.01Hz	50.00Hz	×
P1.04	Load motor Empty current	0.1~500.0A	0.1A	Model Setting	○
P1.05	Load motor stator resistance	0.001~10.000Ω	0.001	Model Setting	×
P1.06	Load motor rotor resistance	0.001~10.000Ω	0.001	Model Setting	×
P1.07	Motor and rotor inductance	0.01~600.00mH	0.01mH	Model Setting	×
P1.08	Motor and rotor mutual inductance	0.01~600.00mH	0.01mH	Model Setting	×

P1.09	Reserved				
P1.10	Factor to the poor compensation	0.50~2.00	0.01	1.00	○
P1.11	Exciting motor pre-selection	0: conditions for effective 1: has been effective	1	0	×
P1.12	Pre-duration of the electrical excitation	0.1~10S	0.1	0.2S	×
P1.13	The electrical parameters of self-learning	0: No action 1: static self-learning (only when P0.00 to 0 effective)	1	0	×
P1.14	Central rate (ASR) proportional gain	0.01~5.00	0.01	1.00	○
P1.15	Central rate (ASR) integration time constants	0.01~10.00S	0.01S	2.00S	○
Auxiliary parameters					
Function Code	Name & Definition	Set Range	Minimum Unit	Factory Default	Modification
P2.00	Starting way	0: Start with starting frequency 1: Speed tracking start	1	0	×
P2.01	Starting freq.	0.00~10.00Hz	0.01Hz	1.00Hz	○
P2.02	Starting freq. duration	0.0~10.0s	0.1s	0.0s	×
P2.03	DC brake current at starting	0.0~100.0%	0.1%	0.0%	○
P2.04	DC brake time at starting	0: DC braking action is not 0.1~30.0s	0.1s	0.0s	×
P2.05	Acc./Dec. mode selection	0: Linear Acc/Dec mode 1: S curve Acc/Dec mode	1	0	○
P2.06	S-curve start of the proportion of time	10.0~40.0%	0.1%	20.0%	×
P2.07	S-curve rise / fall time of	10.0~80.0%	0.1%	60.0%	×

P2.08	AVR function	0: Ban 1: Effective	1	1	×
P2.09	Automatic energy-saving operation	0: Ban 1: Effective	1	0	×
P2.10	FWD/REV dead time	0.1~10.0s	0.1s	0.0s	×
P2.11	Stop mode	0: Decelerating and stopping 1: Free stop	1	0	×
P2.12	DC brake starting freq. at stopping	0.00~20.00Hz	0.01Hz	0.00Hz	○
P2.13	DC brake current at stopping	0.0~100.0%	0.1%	0.0%	○
P2.14	DC brake time when stopping	0: DC braking action is not 0.1~30.0s	0.1s	0.0s	×
P2.15	Power-off restart setting	0: Ban 1: conventional starter 2: Starting track speed	1	0	×
P2.16	Power-off waiting time before restarting	0.0~20.0s	0.1s	0.5s	×
P2.17	Failure self-reset times	0~10	1	0	×
P2.18	Failure self-reset interval	0.5~25.0s	0.1s	3.0s	×
P2.19	Jog run frequency	0.00~50.00Hz	0.01Hz	10.00Hz	○
P2.20	Jog Acc. time	0.1~3600 Note: The default units seconds; acceleration and deceleration time units chosen see P3.09	0.1s	Model Setting	○
P2.21	Jog Dec time		0.1s	Model Setting	○
P2.22	Acc. time 2	0.1~3600 Note: The default units seconds; acceleration and deceleration time units chosen see P3.09	0.1s	Model Setting	○
P2.23	Dec. time 2		0.1s	Model	○

				Setting	
P2.24	Acc. Time3	0.1~3600 Note: The default units seconds; acceleration and deceleration time units chosen see P3.09	0.1s	Model Setting	○
P2.25	Dec. time 3		0.1s	Model Setting	○
P2.26	Acc. time 4	0.1~3600 Note: The default units seconds; acceleration and deceleration time units chosen see P3.09	0.1s	Model Setting	○
P2.27	Dec. time 4		0.1s	Model Setting	○
P2.28	Multi-speed frequency 1	0.0Hz ~ Upper limit freq.	0.01Hz	5.00Hz	○
P2.29	Multi-speed frequency 2	0.0Hz ~ Upper limit freq.	0.01Hz	10.00Hz	○
P2.30	Multi-speed frequency 3	0.0Hz ~ Upper limit freq.	0.01Hz	15.00Hz	○
P2.31	Multi-speed frequency 4	0.0Hz ~ Upper limit freq.	0.01Hz	20.00Hz	○
P2.32	Multi-speed frequency 5	0.0Hz ~ Upper limit freq.	0.01Hz	25.00Hz	○
P2.33	Multi-speed frequency 6	0.0Hz ~ Upper limit freq.	0.01Hz	30.00Hz	○
P2.34	Multi-speed frequency 7	0.0Hz ~ Upper limit freq.	0.01Hz	40.00Hz	○
P2.35	Reserved				
P2.36	Jumping frequency 1	0.0Hz ~ Upper limit freq.	0.01Hz	0.00Hz	○
P2.37	Jumping rance 1	0.0~10.0Hz	0.01Hz	0.00Hz	○
P2.38	Jumping frequency 2	0.0Hz ~ Upper limit freq.	0.01Hz	0.00Hz	○
P2.39	Jumping rance 2	0.0~10.0Hz	0.01Hz	0.00Hz	○
P2.40	Jumping frequency 3	0.0Hz ~ Upper limit freq.	0.01Hz	0.00Hz	○
P2.41	Jumping rance 3	0.0~10.0Hz	0.01Hz	0.00Hz	○
P2.42	Carrier frequency settings	1.0~12.0KHz	0.1KHz	Model Setting	○

P2.43	Carrier control mode	0: fixed carrier 1: automatic adjustment of Carrier	1	1	○
User management interface parameters					
P3.00	LCD language choose	0: Chinese 1: English	1	0	○
P3.01	Initialization parameters	0: Operation 1: restore the factory settings 2: Clear fault records	1	0	×
P3.02	Into the parameters of protection	0: Allow edit all parameters (in the operation of some parameters can not be amended) 1: Amended to allow only the frequency settings 2: Laws prohibit all parameters Note: The above parameters of the invalid	1	0	○
P3.03	Manufacturers password	0~9999	1	0	○
P3.04	Monitoring parameters 1 choice	0~18	1	0	○
P3.05	Monitoring parameters 2 choice	0~18	1	1	○
P3.06	Line speed factor	0.01~100.0	0.01	1.00	○
P3.07	Closed-loop coefficient shows	0.01~100.0	0.01	1.00	○
P3.08	Software version	0~99.99	0.01		×
P3.09	Modified time flat rate	0: seconds 1: Minutes	1	0	○
Digital input and output					
P4.00	Input terminal DI1 function	0: Leave control terminal unused 1: Multi-speed selection 1 2: Multi-speed selection 2 3: Multi-speed selection 3 4: Acceleration and	1	0	×

P4.01	Input terminal DI2 function	deceleration time 1 5: Acceleration and deceleration time 2 6: Frequency channel selection 1 7: Frequency channel selection 2 8: Frequency channel selection 3	1	0	×
P4.02	Input terminal DI3 function	9: Forward jog control 10: Reverse jog control 11: Free stop control 12: Freq. increasing command (UP) 13: Freq. decreasing command (DOWN)	1	0	×
P4.03	Input terminal DI4 function selection (0 ~ 20)	14: External device failure input 15: Three-line run control 16: DC brake order 17: Counter cleared signal input	1	0	×
P4.04	Input terminal DI5 function	18: Counter trigger signal input (only DI6 effective) 19: External pulse input (only DI6 effective) 20: External reset input 21: UP / DOWN frequency terminal cleared 22: PID run into	1	0	×
P4.05	Input terminal DI6 function	23: Programmable multi-speed operation in 24: Wobbling Run into 25: Wobbling State reset 26: External shutdown command 27: Inverter prohibition of operation instructions 28: Inverter prohibition of Acceleration and deceleration instructions (Reserved) 29: Switch to the terminal order 30: Switch to the frequency AI2 31: Reserved	1	0	×
P4.06	FWD / REV terminal control mode	0: second-line-control mode 1 1: second-line-control mode 2 2: three-line-control mode 1 3: three-line-control mode 2 (Reserved)	1	0	×

P4.07	Open collector output terminal DO1 setting	0: Inverter running indication 1: Freq./speed arriving signal (FAR) 2: Freq./speed level detecting signal (FDT) 3: Zero-speed converter in the operation of instructions 4: External failure input 5: Output freq. reaching upper limit	1	0	○
P4.08	Open collector output terminal DO2 setting	6: Output freq. reaching lower limit 7: Programmable multi-speed operation of a complete cycle 8: Inverter overload alarming Signal	1	1	○
P4.09	Programmable relay output	9: Inverter ready for operation 10: Counter detection signal output 11: Counter reset signal output 12: Inverter failure 13: Inverter under-voltage blockage shutdown 14: Wobbling On the threshold limit 15: Programmable multi-speed run ending	1	12	○
P4.10	FDT level setting	0.0 Hz~Upper limit frequency	0.01Hz	10.00Hz	○
P4.11	FDT lag	0.0~30.00Hz	0.1Hz	1.00Hz	○
P4.12	Freq. checkout scope (FAR)	0.00Hz~15.0Hz	0.01Hz	5.00Hz	○
P4.13	Overload pre-alarm level	20~120%	1%	100%	○
P4.14	Overload pre-alarming time	0.0~15.0s	0.1s	1.0s	×
P4.15	Counter Reset value setting	【P4.16】~60000	1	1	×
P4.16	计数器检测值设定	0~【P4.15】	1	1	×

Analog input and output parameters					
P5.00	A11 enter a minimum voltage	0.0~【P5.01】	0.1V	0.0V	○
P5.01	A11 enter a maximum voltage	【P5.00】~10.0V	0.1V	10.0V	○
P5.02	A12 enter a minimum current	0.0~【P5.03】	0.1mA	0.0mA	○
P5.03	A12 enter a maximum current	【P5.02】~20.0mA	0.1mA	20.0mA	○
P5.04	Enter a minimum frequency pulse	0.0~【P5.05】	0.1KHz	0.0KHz	○
P5.05	Enter a maximum frequency pulse	【P5.04】~20.0kHz	0.1KHz	10.0KHz	○
P5.06	Enter the corresponding set minimum frequency	0.0Hz ~ Upper limit freq.	0.01Hz	0.00Hz	○
P5.07	Enter the corresponding set maximum frequency	0.0Hz ~ Upper limit freq.	0.01Hz	50.00Hz	○
P5.08	Analog input signal delay time	0.1~5.0s	0.1s	0.5s	○
P5.09	AO1-Analog Output function choice	0: output frequency 1: Set frequency 2: output current 3: motor speed 4: output voltage 5: bus voltage 6: PID to the quantitative 7: PID feedback of	1	0	○
P5.10	DO3-Pulse Output function choice		1	2	○
P5.11	AO1 to set the gain	20~200%	1%	100%	○
P5.12	Reserved				
P5.13	DO3 to set the gain	20~200% (Rating 10KHZ)	1%	100%	○
P5.14	Reserved				
Function Code	Name & Definition	Set Range	Minimum Unit	Factory Default	Modification

P5.15	Combination of a given channel settings	A B C single-LED: Operation 0: Keyboard Potentiometers 1: Digital setting 2: Reserved 3: Communication setting 4: AI1 5: AI2 6: Terminal Pulse D single-LED: Operation Reserved	1	000	×
P5.16	Combination of a given set algorithm	A B single-LED: Operation 0: Adder 1: Subtraction 2: Absolute value 3: Take the maximum 4: Take the minimum A B single-LED: Operation Reserved	1	00	○
Process PID control parameters					
P6.00	PID action selection	A single-LED: Set up 0: Close 1: Open B single-LED: PID investment choice 0: Automatic 1: The definition of multi-functional terminal manually input C single-LED: Operation Reserved D single-LED: Operation Reserved	1	00	×
P6.01	PID provision channel selection	0: Digit keyboard input 1: Digital setting 2: Reserved 3: Reserved 4: AI1 5: AI2 6: Terminal Pulse 7: AI1+AI2 8: AI1-AI2 9: MIN {AI1, AI2} 10: MAX {AI1, AI2}	1	1	×
P6.02	PID feedback channel selection	0: Digit keyboard input 1: Digital setting 2: Reserved 3: Reserved 4: AI1 5: AI2 6: Terminal Pulse 7: AI1+AI2 8: AI1-AI2 9: MIN {AI1, AI2} 10: MAX {AI1, AI2}	1	4	×

Function Code	Name & Definition	Set Range	Minimum Unit	Factory Default	Modification
P6.03	Digital setting of specified quantity	0.00~10.00V	0.01V	0.00V	○
P6.04	Feedback gain access	0.01~10.00	0.01	1.00	○
P6.05	Feedback channel polarity	0: Positive 1: Negative	1	0	×
P6.06	PID proportional gain P	0.01~10.00	0.01	1.00	○
P6.07	PID integral time Ti	0.1~200.0s	0.1s	1.0s	○
P6.08	Differential time Td	0.0: No differential 0.1~10.0s	0.1s	0.0s	○
P6.09	PID sampling time T	0.00: Automatic 0.01~10.00s	0.01s	0.00s	○
P6.10	Deviation limits	0.0~20.0%	0.1%	0.0%	○
P6.11	Closed-loop preset frequencies	0.0Hz ~ Upper limit freq.	0.01Hz	0.00Hz	○
P6.12	Preset to maintain the frequency of time	0.0~6000.0s	0.1s	0.0s	×
P6.13	Sleeping threshold	0.0~10.00V	0.01	10.00V	○
P6.14	Waking threshold	0.0~10.00V	0.01	0.00V	○
Programmable operating parameters					
P7.00	Programmable operational control (PLC with simple operation and put the Wobbling operation)	A single-LED: Operation choice 0: No Action 1: single loop (Summary PLC) B single-LED: Programmable multi-speed (PLC) running into form 0: Auto 1: The definition of multi-functional terminal manually input C single-LED: Wobbling Running into form 0: Auto 1: The definition of multi-functional terminal manually input C single-LED: Reserved	1	000	×

Function Code	Name & Definition	Set Range	Minimum Unit	Factory Default	Modification
P7.01	Stage 1 run-time	0.0~6000.0s	0.1s	10.0s	○
P7.02	Stage 2 run-time	0.0~6000.0s	0.1s	10.0s	○
P7.03	Stage 3 run-time	0.0~6000.0s	0.1s	10.0s	○
P7.04	Stage 4 run-time	0.0~6000.0s	0.1s	10.0s	○
P7.05	Stage 5 run-time	0.0~6000.0s	0.1s	10.0s	○
P7.06	Stage 6 run-time	0.0~6000.0s	0.1s	10.0s	○
P7.07	Stage 7 run-time	0.0~6000.0s	0.1s	10.0s	○
P7.08	Reserved				
P7.09	The direction of 1 multi	A single-LED:Stage 1 direction 0: FWD 1: REV B single-LED:Stage 2 direction 0: FWD 1: REV C single-LED:Stage 3 direction 0: FWD 1: REV D single-LED:Stage 4 direction 0: FWD 1: REV	1	0000	○
P7.10	The direction of 2 multi	A single-LED:Stage 5 direction 0: FWD 1: REV B single-LED:Stage 6 direction 0: FWD 1: REV C single-LED:Stage 7 direction 0: FWD 1: REV D single-LED: Reserved	1	000	○
P7.11	Wobbling operating parameters	A single-LED: Reserved B single-LED: Wobbling Control C single-LED: Wobbling Starting choose downtime 0: the stands before the memory of the state starting 1: Start re-start Dsingle-LED: Wobbling Power-down state of storage 0: Power-down storage	1	000	×

Function Code	Name & Definition	Set Range	Minimum Unit	Factory Default	Modification
		Wobbling status 1: Power-down Wobbling state does not store			
P7.12	Wobbling preset frequencies	0.0Hz ~ Upper limit freq.	0.01Hz	10.00Hz	○
P7.13	Wobbling Preferences frequency waiting time	0.0~3600.0s	0.1s	0.0s	×
P7.14	Wobbling Amplitude	0.0~50.0%	0.1%	10.0%	○
P7.15	Sudden jump frequency	0.0~50.0% (Compared to Wobbling Amplitude)	0.1%	10.0%	○
P7.16	Wobbling Cycle	0.1~3600.0s	0.1s	10.0s	○
P7.17	Delta waves rise time	0.0~100.0% (Wobbling Cycle)	0.1%	50.0%	○
P7.18	Wobbling Center frequency base	0.0Hz ~ Upper limit freq.	0.01Hz	10.00Hz	○
Communication parameter					
P8.00	Local communication address	1 ~ 30(0: host setting)	1	1	×
P8.01	Communications configuration	A single-LED: Baud rate option 0: 1200BPS 1: 2400BPS 2: 4800BPS 3: 9600BPS 4: 19200BPS 5: 38400BPS B single-LED: Data format 0: No checkout 1: Even checkout 2: Odd checkout C single-LED: Communication failure Action choice 0: stands 1: maintain the status quo D single-LED: Reserved	1	013	×
P8.02	Communications overtime detection time	0.0~100.0s	0.1s	10.0s	×

P8.03	Local response delay	0~1000ms	1ms	5ms	×
P8.04	Linkage of settings	0.01~10.00	0.01	1.00	○
Protection parameters					
Function Code	Name & Definition	Set Range	Minimum Unit	Factory Default	Modification
P9.00	Motor overload protection factor	30%~110%	1%	105%	○
P9.01	Undervoltage protection setting frequency	360~480V	1V	400V	○
P9.02	Over-voltage level of restrictions	660~760V	1V	700V	○
P9.03	Current limiting level	120%~220%	1%	180%	○
High functional parameters					
PA.00	Zero-run threshold	0.00~50.00Hz	0.01Hz	0.00Hz	○
PA.01	Zero-Backlash	0.00~50.00Hz	0.01Hz	0.00Hz	○
PA.02	Start-voltage power brake	600~720V	1V	700V	○
PA.03	Energyconsumption ratio of braking action	10~100%	1%	50%	○

PA. 04	Cooling fan control	0: Automatic Control Mode 1: power process has been functioning	1	0	○
PA. 05	UP / DOWN terminal modified rate	0. 01Hz~100. 0Hz/S	0. 01Hz/S	1. 00Hz/S	○
PA. 06	So that the modulation	0: Ban 1: Allow	1	0	×
PA. 07	Reserved				
PA. 08	Reserved				
PA. 09	Reserved				
PA. 10	Reserved				
PA. 11	Reserved				
PA. 12	Reserved				
Manufacturers parameters					
Function Code	Name & Definition	Set Range	Minimum Unit	Factory Default	Modification
PB. 00	Reserved				×
PB. 01	Reserved				×
PB. 02	Reserved				
PB. 03	Reserved				
PB. 04	Reserved				
PB. 05	Reserved				
PB. 06	Reserved				

monitoring parameterS	
Monitoring Code	Name
D-00	Output frequency (Hz)
D-01	Set frequency (Hz)
D-02	Output current (A)
D-03	Output voltage (V)
D-04	Motor speed (RPM/min)
D-05	Operating speed line (m/s)
D-06	Set speed line (m/s)
D-07	Bus voltage (V)
D-08	Input Voltage (V)
D-09	PID Settings
D-10	PID Feedback value
D-11	Analog input AI1(V)
D-12	Analog input AI2(A)
D-13	Pulse input frequency (KHz)
D-14	Input terminals state
D-15	Radiator temperature (°C)
D-16	Module temperature (°C)
D-17	The current value of
D-18	Setting of numerical
D-19	The first fault code

D-20	The Second fault code
D-21	The Third fault code
D-22	The first failure output frequency (Hz)
D-23	The first failure set frequency (Hz)
D-24	The first failure output current (A)
D-25	The first failure output voltage (V)
D-26	The first failure output Bus voltage (V)
D-27	The first failure output module temperature(°C)
D-28	Software version
Fault code	
Fault code	Name
Er-00	Over current at accelerating operation
Er-01	Over current at decelerating operation
Er-02	Over current at constant speed operation
Er-03	Over voltage at accelerating operation
Er-04	Over voltage at decelerating operation
Er-05	Over voltage at constant speed operation
Er-06	Over voltage at stopping
Er-07	Under voltage at operating

Er-08	Phase failure of input power
Er-09	Module fault
Er-10	Over heat radiator
Er-11	Overload of inverter
Er-12	Overload of motor
Er-13	Fault of external equipment
Er-14	Fault of serial port communication
Er-15	Reserved
Er-16	Incorrect current detection
Er-17	Fault of communication between keyboard and control panel
Er-18	System fault
Er-19	Reserved

6 Parameter Function Descriptions

Detailed Parameter Function Description

6.1 Parameter Group -- Basic function

P0.00	Speed Control Mode	Factory	1
	Setting range	0	Sensorless vector
		1	V/F control

0: Sensorless vector control

It is widely used for the application which requires no-PG encoder drives with high performance and adjustable Speed. One inverter can be used to drive only one motor, such as machine tool, centrifugal machine and wire-drawing machine, etc.

1: V/F control

It is suitable for the application requiring lower speed control and torque control, such as draught fans, pumps etc. It can be used to drive multi motors.

Notice:

1. In the vector control mode, the autotuning of motor parameters must be accomplished properly before the first running in order to get exact motor parameters. Once the autotuning is finished, these obtained motor will be saved in the control board for following running usage. It is especially noticed that motor name-plate data must be correspond with motor parameters of inverter before autotuning, otherwise it will cause failure of autotuning or wrong results. When you can not get information of motor name-plate data, please select V/F control mode.

2. In the vector control mode, in order to achieve better stability and dynamic response, the parameters of ASR (refer to P1.14, P1.15 please) should be correct set.

3. In the vector control mode, one inverter can drive only one motor. And the voltage grade of inverter and motor can not differ largely, otherwise it will affect the better control of motors or even make the motors malfunction.

S52

P0.01	Frequency Preset Source Selection	Factory Setting	1
	Setting range	0	Keypad regulation resistance
		1	Digital Preset 1(set by ▲/▼ or digital encoder)
		2	Digital Preset 2(set by UP/DOWN)

		3	Digital Preset 3(Communication)
		4	AI1 analog input (0~10V)
		5	AI2 analog input (0~20mA)
		6	HD1 (0~20kHz)
		7	Combination
		8	External terminals

0: Keypad regulation resistance

The reference frequency is set by keypad regulation resistance (on LED keypad).

1: Digital Preset 1

The reference frequency is determined by P0.03. User can use button  on operation keyboard or digital encoder to adjust running frequency. The adjusted frequency value will be saved in P0.03. User can also set P0.02 parameter to clear this adjusted value.

Notice:

LCD keypad supports digital encoder, but not analog regulation resistance. This encoder can use as  and **SET** to achieve adjusting digital frequency and function parameters, parameters save etc. So it is convenient for users. But when use the encoder, please set P0.01 to 1, not 0, otherwise it will be disabled to preset frequency. Furthermore, when you use analog regulation resistance to select frequency, make use of LED keypad or external encoder please.

2: Digital Preset 2

The reference frequency is set by external UP/DOWN terminals which are preset to control frequency. When UP-COM is closing, frequency will be increased; When DOWN-COM is closing, frequency will be lower; When UP/DOWN is closing or opening a contact with COM simultaneously, frequency will be not changed. These adjusted frequency values will be saved in P0.03 when power off. Frequency adjustment speed of UP/DOWN is determined by PA.05

3: Digital Preset 3

The reference frequency is set by host through RS485 connector.

4: AI1 analog input (0~10V)

The reference frequency is set by external voltage input terminal AI1 (0~10V) . Please refer to P5.00-P5.01.

5: AI2 analog input (0~20mA)

The reference frequency is set by external voltage input terminal AI2 (0~20mA/0~10V) . Please refer to P5.02-P5.03.

6: HD1 (0~20kHz)

The reference frequency is set by DI6 through pulse signal input (0~20kHz) . Please refer to P5.02-P5.03.

7: Combination

The reference frequency is determined by linear combinations of preset sources. Combinations please refer to P5.15-P5.16.

8: External terminals

The reference frequency is the result of 8 opening / closing combinations of multi-function terminals which are set by P4.00-P4.05. (If it is set to 0, multi-function terminal will open a contact with COM terminal, if it is set to 1, multi-function terminal will close a contact with COM.) Detailed Combinations please see below:

Source Selection Terminal 3	Source Selection Terminal 2	Source Selection Terminal 2	Frequency Preset Source Selection
0	0	0	Keypad regulation resistance
0	0	1	Digital Preset 1
0	1	0	Digital Preset 2
0	1	1	Digital Preset 3
1	0	0	AI1 analog input
1	0	1	AI2 analog input
1	1	0	HD1

1	1	1	Combination
---	---	---	-------------

Table 6-1**Notice:**

This function is suitable for application which requires real-time switch frequency command sources. If switch between voltage preset and current preset is needed, it means, sometimes through voltage to select frequency, sometimes through current source to select it, it will achieved by above switch combinations of “100”和“101”. The frequency source selection can be selected also by multifunctional terminal which is defined to “switch frequency to AI2”.

P0.02	Digital Frequency Control	Factory Setting	00
	Setting range	00-11	

LED unit position

0: Save the reference frequency value in function code P0.03 when power off. When inverter power on, the saved value will be automatically displayed.

1: The frequency value will not be saved when power off. When inverter power on, it will run from 0.0Hz.

LED tens place

0: The reference frequency value will not be saved when power off.

1: The reference frequency value will be saved in P0.03 when power off.

Notice:

Setting for LED unit position valid only when P0.01=1、2、3.

Setting for LED tens place valid when P0.01=2、3. When P0.01=1(digital preset 1), the frequency value when power off will be always as a default saved.

P0.03	Run frequency digital preset	Factory Setting	0
--------------	-------------------------------------	-----------------	----------

	Setting range	0.00-Upper frequency limit
--	---------------	----------------------------

When P0.01=1、2、3, this parameter is the initial value of inverter reference frequency.

When the operation panel is in the control mode, when P0.01=1, user can use the key  to adjust this parameter; When P0.01=2, the frequency will run from the initial value of reference frequency, and then be adjustable by means of UP/DOWN.

P0.04	Run Command Source	Factory Setting	0
	Setting range	0	Keypad
		1	Terminal
		2	Communication

This parameter can set physical sources for control commands such as start, stop, forward run and so on.

0: Keypad

The keys **RUN**, **STOP/RESET**, **REV/JOG** in the keypad are used for running command control.

In this running status, the state of FWD will affect the output phase sequence of inverter. When FWD is connected to COM, output phase sequence will be opposite to the preset; when cut the connection of FWD and COM, output phase sequence will be same as the preset sequence.

1: Terminal

Running commands will be determined by FWD, REV and COM terminals, the mode is set by P4.06. Inverter factory setting as following:

Command	Terminal status
Stop	FWD,REV and COM closing or opening connection simultaneously
Forward run	FWD and COM closing connection while REV and COM opening connection

Reverse run	REV and COM closing connection while FWD and COM opening connection
--------------------	---

Table 6-2**2: Communication**

Running commands are set by upper inverter by means of communication.

P0.05	Running direction selection	Factory Setting	0
	Setting range	0	Forward
		1	Reverse
		2	Forbid reverse

It is used to change the rotation direction of motor without changes of other parameters. The function can be achieved also by adjusting any 2 motor output wires.

0: Forward**1: Reverse****2: Forbid reverse****Notice:**

When this parameter is selected, after autotuning, the rotation direction of motor will be restored to previous direction. Please be cautious to use in conditions of forbidding motor rotation adjustment.

P0.06	Upper frequency limit	Factory Setting	50.00Hz
	Setting range	[F0.07]—400.0Hz	
P0.07	Lower frequency limit	Factory Setting	0.00Hz
	Setting range	0.00Hz—[F0.00]	

Upper frequency limit is the inverter running maximum frequency, symbol is f_u , its setting range is [P0.07]—400.0Hz; Lower frequency limit is the inverter running minimum frequency, symbol is f_l , its setting range is 0.00Hz—[P0.06]; When inverter begins to run, it will run from starting frequency. When selected frequency is lower

than lower frequency limit, inverter will run with lower frequency limit until it stops or selected frequency exceeds lower frequency limit.

P0.08	Basic Running Frequency	Factory Setting	50.00Hz
	Setting range	1.00—Upper frequency limit	

Basic running frequency fb is the corresponding minimum frequency to maximum output voltage, generally motor rated frequency. It determines frequency setting and ACC / DEC time. Please be cautious to adjust it.

P0.09	Maximum Output Voltage	Factory Setting	380V/220V
	Setting range	200V—500V/100V—250V	

Maximum output voltage is the corresponding maximum output voltage to basic running frequency fb, generally motor rated voltage. It is valid for V/F control mode to adjust output voltage, but invalid for vector control mode.

P0.10	Inverter Model Selection	Factory Setting	0
	Setting range	0	M model
		1	FP model

0: M model

Applicable to constant torque load.

1: FP model

Applicable to variable torque load such as pumps and draught fans. For this kind of load, inverter can increase one power rating degree.

Notice:

Do not change these parameters, otherwise it may affect inverter current display until it malfunctions.

P0.11	Torque Boost Operation	Factory Setting	0
	Setting range	0	By hand
		1	Auto

Torque boost can improve the torque performance of V/F control at low speed. Invalid for vector control mode.

0: By hand

Torque boost voltage is determined by P0.12.

1: Auto

Torque boost voltage is determined by stator current. The bigger the current, the larger the value.

When it is set to auto torque boost, it can avoid saturable magnetic circuit caused by over torque boost voltage during too light load, therefore motor overheat caused by low speed run will be avoided.

Below equation for auto torque boost operation:

Torque boost operation= $(P0.12/200) \times P0.09 \times (\text{inverter output frequency} / \text{inverter rated current})$

Calculation for Mutual torque boost is the same, but its equation needs to remove the part (inverter output frequency/ inverter rated current). Torque boost is determined by load, the heavier the load, the larger the value. This value should not be too large, otherwise the motor would over excite, be overheat or the inverter would be tripped by over-current or over-load.

P0.12	Torque Boost Setting	Factory Setting	Model Setting
	Setting range	0—30%	

Torque boost can improve the torque voltage of V/F control at low speed. Please



图 6-1 转矩提升设置

P0.13	Slip Frequency Compensation	Factory Setting	0.0%
	Setting range	0.0—150.0%	

Load change may take effects on motor slip frequency. This parameter is used to adjust inverter output frequency according to load automatically. If inverter runs with 50Hz rated current, motor speed must be lower than the corresponding to 50Hz speed. Then if you will increase motor speed, you must select this parameter.

Notice: Valid only when P0.00=1.

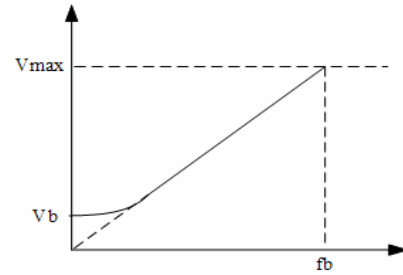
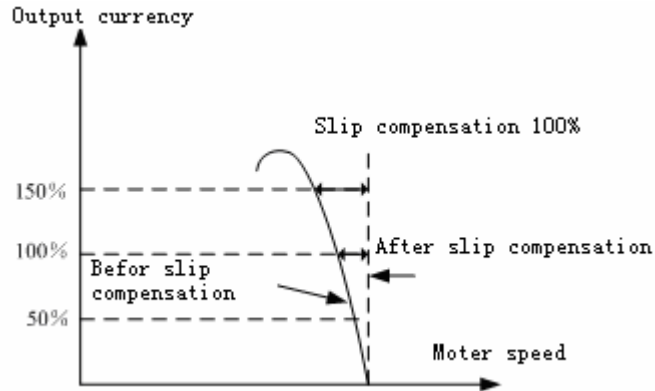

Figure 6-2 Slip Frequency Compensation Diagram

P0.14	Acceleration Time 1	Factory Setting	Model Setting
P0.15	Deceleration Time 1	Factory Setting	Model Setting
	Setting range	0.1—3600s	

Acceleration time is the time of accelerating from 0Hz to reference frequency, please see its symbol t1 below. Deceleration time is the time of decelerating from reference frequency to 0Hz, please see its symbol t2 below.

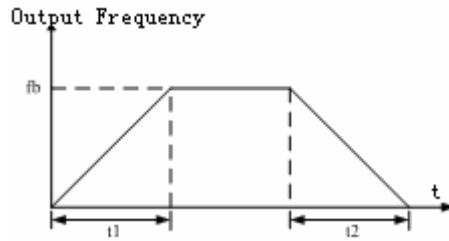

Figure 6-3 Acceleration and Deceleration time

Inverter has 4 groups of acceleration and deceleration time, group 2, 3, 4 will be set by P2.22-P2.27. Inverter sets group 1, namely P0.14、 P0.15 as its factory setting. If other groups are needed, please use control terminals.

P0.16	V/F Curve Selection	Factory Setting	0
	Setting range	0-3	

0: Linear Curve

It is applicable for normal constant torque load. Output Voltage and output frequency are linear correlated.

1: Torque-step down curve 1

Torque-step down curve with 1.7 order.

2: Torque-step down curve 2

Torque-step down curve with 2.0 order.

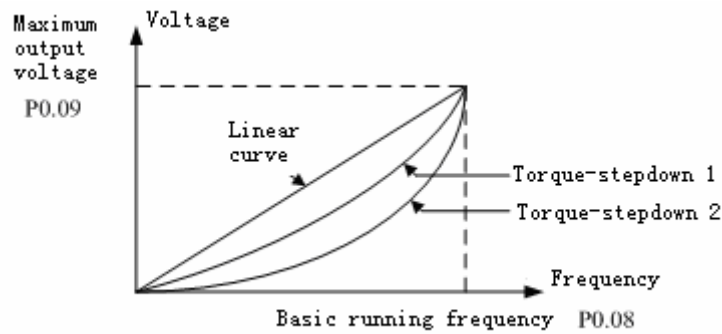

Figure 6-4 Multiple V/F Curve Diagram

Curve 1 and 2 are applicable for variable torque load, such as draught fans, pumps etc. Curve 2 is better than curve 1 in energy conservation. But when motor runs along curve and 2, it will underexcite and run unsteadily, so you can select V/F curve according to actual situation or better self-defined curve.

3: User-defined Curve

It can be defined through setting of P0.17—P0.22(refer to figure 6-5 please). Notice: Valid only when P0.00=1.

P0.17	V/F Frequency F1	Factory Setting	12.50Hz
	Setting range	0.00—Frequency F2	
P0.18	V/F Voltage V1	Factory Setting	25.0%
	Setting range	0.0—Voltage V2	
P0.19	V/F Frequency F2	Factory Setting	25.00Hz
	Setting range	频率值 F1—Frequency F3	
P0.20	V/F Voltage V2	Factory Setting	50.0%
	Setting range	Voltage V1—Voltage V3	
P0.21	V/F Frequency F3	Factory Setting	37.50Hz
	Setting range	Frequency F2—Basic Running Frequency	
P0.22	V/F 电压值 V2	Factory Setting	75.0%
	Setting range	Voltage V2—100.0%	

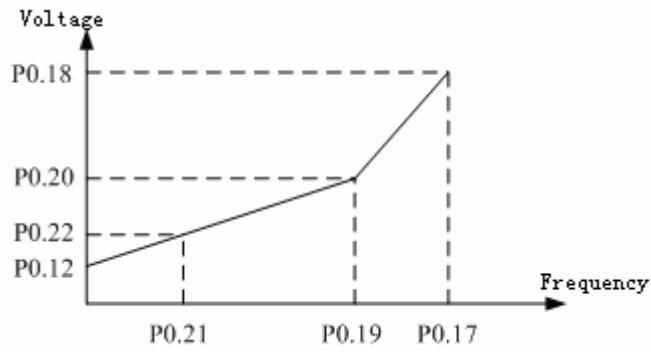

Figure 6-5 V/F User-defined Curve

P0.23	REV/JOG Function Selection	Factory Setting	1
	Setting range	0	REV
		1	JOG

REV/JOG is a multifunctional key, whose function can be defined by the value of P0.23.

0: Reverse run function

1: Jog function

6.2 Parameter Group—Motor and Vector Control

P1.00	Motor Rated Voltage	Factory Setting	380V/220V
	Setting range	200V—500V/100V—250V	
P1.01	Motor Rated Current	Factory Setting	Model Setting
	Setting range	0.1—500.0A	
P1.02	Motor Rated Speed	Factory Setting	Model Setting
	Setting range	300—3000RPM	
P1.03	Motor Rated Frequency	Factory Setting	50.00Hz
	Setting range	1.00—400.00Hz	

P1.04	Motor Current without load	Factory Setting	0.1A
	Setting range	0.1—500.0A	

These parameters are motor electrical parameters. If the power rating of inverter do not match the motor exactly(however, power bias can not be two levels), then actual motor rated current must be inputted in P1.01. So that motor parameters record after autotuning will be exact and the control performances will be effective.

P1.05	Motor Stator Resistance	Factory Setting	Model Setting
	Setting range	0.001—10.000Ω	
P1.06	Motor Rotor Resistance	Factory Setting	Model Setting
	Setting range	0.001—10.000Ω	
P1.07	Motor Leakage Inductance	Factory Setting	Model Setting
	Setting range	0.01—600.00mH	
P1.08	Motor Mutual Inductance	Factory Setting	Model Setting
	Setting range	0.01—600.00mH	
P1.09	Reserved		

These parameters are motor electrical parameters which are needed for vector control mode.

In software system, parameter group of four-pole motors will be preset as default value. But these parameters will probably be not same as electrical parameters of current controlled motor. So in order to better control performances, it will be recommended to use Motor Parameters Autotuning to get exact parameters of this motor.

After autotuning, the value of P1.05-P1.08 will be automatically updated.

Notice:

When run motor parameters autotuning, please ensure to input motor name-plate parameters accurately. When the power rating of inverter do not match with motor and run vector control mode without parameters autotuning, it may deteriorate the control performance of inverter.

P1.10	Slip Compensation Coefficient	Factory Setting	1.00
	Setting range	0.50—2.00	

It is used to control motor speed accuracy in vector control status without speed sensor.

When increase motor load, will increase this parameter to add motor speed; when decrease motor load, will decrease this parameter.

P1.11	Motor Pre-excitation Selection	Factory Setting	0
	Setting range	0	Conditionally valid
		1	Always valid

When motor power off and power on to start, in order to get enough starting torque, it must set up air gap magnetic flux at first.

0: Conditionally valid

When it is set to 0, motor will do pre-excitation before starting, and then increase speed after by P1.12 defined pre-excitation duration. It will be also controlled by multifunctional terminal which is defined as “run pre-excitation command.” (Reserved at present)

1: Always valid

Inverter will do pre-excitation from starting (it means, from 0Hz constantly).

P1.12	Motor Pre-excitation Duration	Factory Setting	0.2
	Setting range	0.1~10.0S	

This parameter is used to set motor pre-excitation duration in vector control mode. In pre-excitation status, motor will run with rated-excitation current, which is similar to DC braking mode. Therefore, in order to get DC braking effect in vector control mode (generally DC braking disabled in vector control mode), please set parameters of

Motor pre-excitation selection and duration together.

P1.13	Motor Parameters Autotuning	Factory Setting	0
	Setting range	0	No action
		1	Static Autotuning

0: No action

1: Static Autotuning

When it is set to 0, once press, it will run motor parameters autotuning automatically by system. It needs no mutual action. During performing autotuning, inverter does not react to other running commands. After autotuning, this parameter will be reset to 0, and parameters record through autotuning will be saved in inverter control board, which means, parameters in P1.05-P1.08 will be updated conditionally.

Notice: This parameter valid only when in vector control mode(P0.00=0) and keypad source command (P0.04=0).

Notice :

If it has over-heat faults during parameters autotuning, please check whether motor current matches with inverter rated current at first. When performing autotuning, motor must be in static status, otherwise autotuning can not run properly. Static autotuning is especially applicable for parameters measurement while motor axle is holding load.

P1.14	ASR Proportional Gain	Factory Setting	1.00
	Setting range	0.01~5.00	
P1.15	ASR Integral Time	Factory Setting	2.00S
	Setting range	0.01~10.00S	

Above parameters are valid for vector control mode, invalid for V/F control mode.

The system's dynamic response can be faster if the proportion gain is increased. However, if proportion gain is too large, the system tends to oscillate. The system's dynamic response can be faster if the integral time is decreased. However, if it is too small, the system becomes overshoot and tends to oscillate. Ensure to increase the proportional gain and reduce the integral time as far as possible without creating

oscillation, so that better system dynamic response suitably.

6.3 Parameter group—Start and Stop Control

P2.00	Start Mode	Factory Setting	0
	Setting range	0	Start frequency directly
		1	Speed tracking and start
P2.01	Starting Frequency	Factory Setting	0.00Hz
	Setting range	0.00—10.00Hz	
P2.02	Hold Time Of Starting Frequency	Factory Setting	0.0s
	Setting range	0.0~10.0s	

0: Start frequency directly

Most motors use the start mode “start directly”, its starting parameters setting please refer to P2.01 and P2.02 above. For system which needs high starting torque, user can use starting frequency to increase torque. Hold time of starting frequency refers to Duration of starting frequency. Please adjust it according to the actual situation. When it is set to 0, it means, starting frequency invalid and motor will start from 0HZ. Parameters for DC Braking Current before Start and DC Braking time Before Start please refer to P2.03 and P2.04.

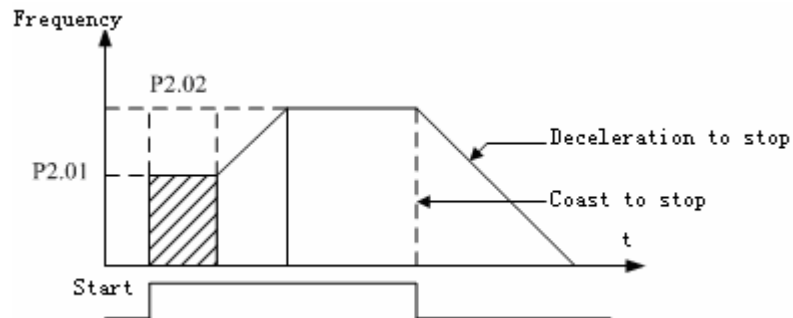

Figure 6-6 Starting and Stopping Diagram

1: Speed tracking and start

Inverter detects the rotation speed and direction of motor, and then start running to its reference frequency based on current rotation speed. This can realize smooth start of rotating motor with big inertia load during motor running status. Ensure to match starting frequency and load, otherwise it will cause current foldback. When system inertia is too large, please adjust the value of ACC / DCC time accordingly.

P2.03	DC Braking Current Before Start	Factory Setting	0.0%
	Setting range	0—100.0%	
P2.04	DC Braking Time Before Start	Factory Setting	0.0s
	Setting range	0.0—30.0s	

DC braking current before start is the percentage of rated current of inverter when inverter performs DC braking to start.

DC braking time before start refers to DC braking current duration before start. When it is set to 0s, this function valid. When P2.03 and P2.04 are selected, inverter performs DC braking according to P2.03 firstly, then start to accelerate after P2.04 to running frequency.

Notice: Valid only when P0.00=1

P2.05	Acceleration / Deceleration Mode	Factory	0
	Setting range	0	Linear
		1	S curve

0: Linear

Output frequency will increase or decrease with fixed acceleration or deceleration time. Output frequency is linear correlated with ACC / DCC time. It is applicable for most motors.

1: S curve

Output frequency will increase or decrease according to S curve. Please refer to Figure 6-7. This function is widely used to reduce noise and vibration during acceleration and deceleration and smooth stop and stop. For details, please refer to description of P2.06 and P2.07.

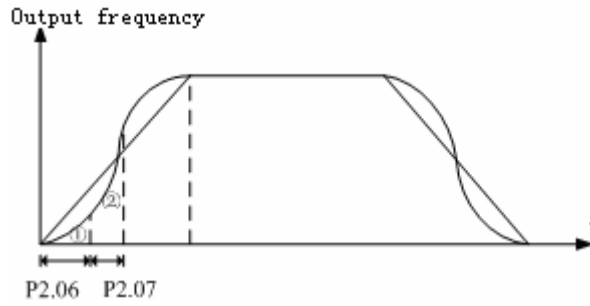

Figure 6-7 S Curve Diagram

P2.06	Start Section of S Curve	Factory Setting	20.0%
	Setting range	10.0—40.0%	
P2.07	Raise and Fall Section of S Curve	Factory Setting	60.0%
	Setting range	10.0—40.0%	

During ① period, the change rate of output frequency increases from 0;

During ② period, the change rate of output frequency remains constant.

Parameters above are used to start and stop for the application requiring delivery, transport and carry.

P2.08	AVR Function	Factory Setting	1
	Setting range	0	Disabled
		1	Enabled

0: Disabled

1: Enabled

AVR(Auto voltage regulation) function ensures the output voltage of inverter stable when inverter input voltage has bias with rated voltage. This function will be invalid when instruction voltage exceeds input power voltage.

During deceleration, if AVR function is disabled, the deceleration time will be short

but the current will be big. If AVR function is enabled, the deceleration time will be long but the current will be small.

P2.09	Auto Energy Saving Selection	Factory	0
	Setting range	0	Disabled
		1	Enabled

0: Disabled

1: Enabled

When it is set to 1, inverter detects motor load automatically, and adjusts or reduces output voltage to keep motor running and saves energy.

It saves energy effectively when this function code is used for application requiring low frequency variation and big variation range. When it takes effects, it will use pre-excitation while motor light load to keep motor running effectively, so that motor energy cost will be reduced.

Notice:

It is suitable for Pumps and draught fans etc.

P2.10	Dead Time of FWD / REV	Factory Setting	0.0s
	Setting range	0.1—10.0s	

When inverter is in the running Status, set the hold time t1 at zero frequency in the transition between forward and reverse running. It is shown as following figure.

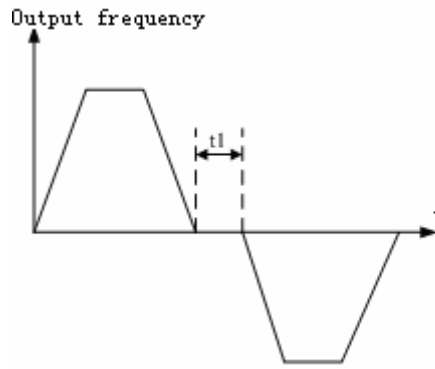

Table 6-8 FWD / REV Dead Time Diagram

P2.11	Stop Mode	Factory Setting	0
	Setting range	0	Deceleration to stop
		1	Coast to stop

0: Deceleration to stop

When the stop command takes effect, the inverter decreases the output frequency and stop when frequency to 0.

If inverter selects DC braking function, it will brake when DC braking frequency is reached, and then stop.

1: Coast to stop

When the stop command takes effect, the inverter blocks the output immediately. The motor coasts to stop by its mechanical inertia.

In this stop mode, it will make use of external mechanical contracting brake to stop fast.

This stop code is not suitable for some pumps load, otherwise it will cause pipeline broke because of water hammer effect.

Parameters of deceleration to stop and DC braking please refer to P2.12, P2.13, P2.14.

P2.12	Starting Frequency of DC Braking	Factory Setting	0.00Hz
	Setting	0.0—20.00Hz	
P2.13	DC Braking Current	Factory Setting	0.0%
	Setting	0.0—100.0%	
P2.14	DC Braking Time	Factory Setting	0.0s
	Setting	0.0—30.0s	

These parameters are used to select DC braking parameters when inverter stops.

P2.12 refers to starting frequency of DC braking during deceleration to stop;

P2.13 refers to percentage of output frequency of DC braking during deceleration to stop to inverter rated output current;

P2.14 refers to DC braking Duration. When it is set to 0.0s, it means no DC braking process.

P2.15	Restart After Power Off	Factory Setting	0
	Setting range	0	Disabled
		1	Start frequency directly
		2	Speed tracking and start
P2.16	Delay Time For Restart	Factory Setting	0.5s
	Setting range	0.0—20.0s	

0: Inverter will not automatically restart when power on again until run command takes effect.

1: When inverter is running, after power off and power on again, inverter will start the motor at the starting frequency after delay time defined by P2.16 .

2: When inverter is running, after power off and power on again, inverter will do speed tracking and start the motor after delay time defined by P2.16.

During delay time , any commands will be invalid. When stop command is selected, the inverter will restore from speed tracking to stop status automatically.

Notice: Setting this parameter will cause unexpected motor start which may affect external equipments and staffs. Please be cautious to use.

P2.17	Auto Reset Times	Factory Setting	0
	Setting range	0-10	

P2.18	Resetting Interval	Factory Setting	3.0s
	Setting range	0.5-25.0s	

When there are faults during running status, the inverter will stop to output and show faults code. After resetting interval of P2.18, the inverter will reset the fault automatically and run again.

Auto reset times is determined by P2.17. When P2.17 is set to be 0, it means auto reset is disabled and mutual reset is enabled by **STOP/RESET**.

This function is valid for some faults such as over heat or over load.

P2.19	Jog Frequency	Factory Setting	10.00Hz
	Setting range	0.00—50.00Hz	
P2.20	Jog Acceleration Time	Factory Setting	Model Setting
P2.21	Jog Deceleration Time	Factory Setting	Model Setting
	Setting range	0.1—3600s	

All above parameters define relevant parameters in jog running status. See below please:

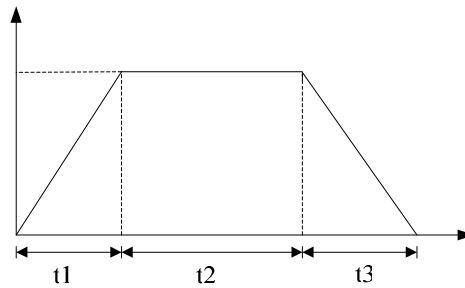

Figure 6-9 Jog Frequency Diagram

t_1 is actual jog acceleration time, t_3 is actual jog deceleration time, t_2 is jog running

time, f_1 is the jog running frequency.

It is noticeable that P2.20 and P2.21 preset the acceleration and deceleration time based on 50Hz jog frequency, but factory setting value of jog frequency is 10Hz, so user can do the conversion proportionally and actual acceleration / deceleration time is 20% of the setting value in P2.20 and P2.21.

Moreover, user can use operation keypad, control terminals or host to run jog command.

P2.22	Acceleration Time 2	Factory Setting	Model Setting
P2.23	Deceleration Time 2	Factory Setting	Model Setting
P2.24	Acceleration Time 3	Factory Setting	Model Setting
P2.25	Deceleration Time 3	Factory Setting	Model Setting
P2.26	Acceleration Time 4	Factory Setting	Model Setting
P2.27	Deceleration Time 4	Factory Setting	Model Setting
	Setting range	0.1-3600s	

Unit selection of all above parameters please refer to description of P3.09.

These Parameters are used to preset the ACC / DEC time 2、3、4.

ACC / DEC time 1、2、3、4(in P0.14 and P0.15 defined as ACC / DEC 1) can be set by combination of control terminals as the inverter acceleration and deceleration time in running status. User can use parameter group P4.00-P4.0 to select these corresponding terminals.

P2.28	Multi-step speed 1	Factory Setting	5.00Hz
P2.29	Multi-step speed 2	Factory Setting	10.00Hz
P2.30	Multi-step speed 3	Factory Setting	15.00Hz
P2.31	Multi-step speed 4	Factory Setting	20.00Hz
P2.32	Multi-step speed 5	Factory Setting	25.00Hz
P2.33	Multi-step speed 6	Factory Setting	30.00Hz
P2.34	Multi-step speed 7	Factory Setting	40.00Hz
P2.35	Reserved		

	Setting range	0.00-Upper frequency limit
--	---------------	----------------------------

Above parameters are used to select running frequency of multi-step speed 1~7. For Details, please refer to P7.00.

P2.36	Skip Frequency 1	Factory Setting	0.00Hz
P2.38	Skip Frequency 2	Factory Setting	0.00Hz
P2.40	Skip Frequency 3	Factory Setting	0.00Hz
	Setting range	0.0—Upper frequency limit	
P2.37	Skip Frequency Bandwidth 1	Factory Setting	0.00Hz
P2.39	Skip Frequency Bandwidth 2	Factory Setting	0.00Hz
P2.41	Skip Frequency Bandwidth 3	Factory Setting	0.00Hz
	Setting range	0.0—10.0Hz	

By means of setting skip frequency, the inverter can keep away from the mechanical resonance points with the load. Once these resonance points are set, inverter can keep away from the points automatically and run smoothly. But inverter frequency will transmit through these points. Three resonance points are set together. When setting range is 0, the skip function of resonance points is invalid and inverter frequency skip run near to some points. See Figure 6-10 please.

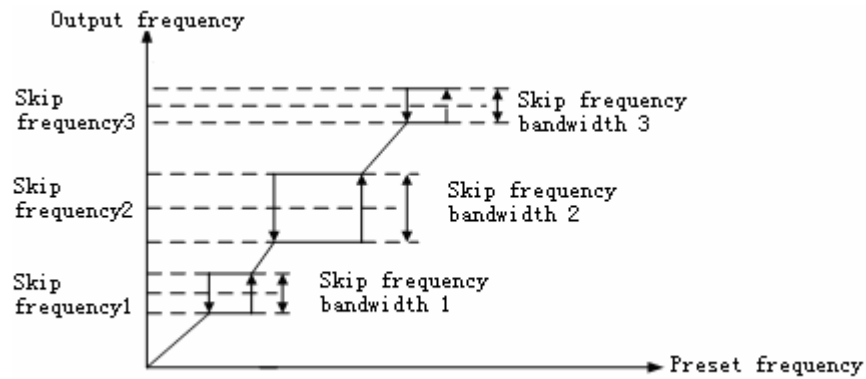

Figure 6-10 Skip Frequency Diagram

P2.42	Carrier Frequency	Factory Setting	Model Setting
	Setting range	1.0—12.0KHz	

This parameter is used to set carrier frequency of PMC.

Carrier frequency will lower the noise of inverter motor. In some circumstances which require mute running, it can be suitably increased. But if the carrier frequency exceeds the factory setting, it will cause higher temperature rise of inverter and stronger electromagnetic interference, so adjust it cautiously please .

When carrier frequency is set to above, if increase it 1 kHz, the inverter output frequency will increase 5% accordingly.

P2.43	PWM Mode	Factory Setting	1
	Setting range	0	Fixed
		1	Random

0: Fixed

1: Random

When mode is set to random, carrier frequency will be adjusted automatically during variation of frequency in order to better pulsation of low frequency torque.

6.4 Parameter Group—Display Interface

P3.00	LCD Language Selection	Factory Setting	0
	Setting range	0	Chinese
		1	English

0: Chinese

1: English (reserved at present)

It is used to select languages on operation panel. It is valid only with LCD display keypad.

P3.01	Parameters Restore	Factory Setting	0
	Setting range	0	No action
		1	Restore factory setting
		2	Clear fault records

0: No action

Inverter is in the status which user can read and write parameters.

1: Restore factory setting

Inverter restores all parameters to factory setting in PO-PA groups.

Notice:

This function code is invalid for P0.00, P0.01, P0.04, P0.10 groups. These main parameters are only adjusted by hand. And this function code will clear all records after motor parameters autotuning. So it is needed to run autotuning again when in the vector control mode.

2: Clear fault records

Inverter clears all fault records.

P3.02	Parameters Write-Protect	Factory Setting	0
	Setting range	0	Permit to change all Parameters
		1	Permit to change parameters of frequency
		2	Forbid to do changes

0: Permit to change all Parameters

Notice: In the running status, some parameters can not be changed. For details, please refer to *list of function parameters*.

1: Permit to change parameters of frequency**2: Forbid to do changes**

This function code is used to forbid others to change inverter parameters setting.

P3.03	Factory Password	Factory Setting	0
	Setting range	0—9999	
P3.04	Control Data 1	Factory Setting	0
	Setting range	0—18	
P3.05	Control Data 2	Factory Setting	1
	Setting range	0—18	

It determines display of control board in control status, that is, display on LED and LCD. Control Data 1 is showed on LED and control data 2 in the left-under angular region of LCD panel.

P3.06	Linear Velocity Coefficient	Factory Setting	1.00
	Setting range	0.01—100.0	

When displayed velocity is linear velocity, it will be calculated by the following

equation:

Linear Velocity = **Frequency** Linear Velocity Coefficient

P3.07	Closed-loop Display Coefficient	Factory Setting	1.00
	Setting range	0.01—100.0	

PID Feedback / Preset Value= Closed-loop Display Coefficient **Actual Feedback / Preset Value**

P3.08	Program Version	Factory Setting	
	Setting range	0—99.99	

This parameter can show the version number of program.

P3.09	Acceleration/Deceleration Speed Time	Factory Setting	0
	Setting range	0	Second
		1	Minute

0: Second

1: Minute

This Parameter is set for acceleration and deceleration speed time and defaulted as second.

6.5 Parameters Group—Input and Output

P4.00	Input Terminal DI1 Function	Factory Setting	0
P4.01	Input Terminal DI2 Function	Factory Setting	0
P4.02	Input Terminal DI3 Function	Factory Setting	0
P4.03	Input Terminal DI4 Function	Factory Setting	0
P4.04	Input Terminal DI5 Function	Factory Setting	0
P4.05	Input Terminal DI6 Function	Factory Setting	0
	Setting range	0—30(Detailed description see below please)	

0: Control terminals unused

1: Multi-Step Speed Selection 1

2: Multi-Step Speed Selection 2

3: Multi-Step Speed Selection 3

User will use ON/OFF combinations of multi-step speed terminals to chose output step speed, see Table 6-3 please:

Multi-Step Speed	Multi-Step Speed	Multi-Step Speed	Step Speed
------------------	------------------	------------------	------------

OFF	OFF	OFF	Normal Running
OFF	OFF	ON	1
OFF	ON	OFF	2
OFF	ON	ON	3
ON	OFF	OFF	4
ON	OFF	ON	5
ON	ON	OFF	6
ON	ON	ON	7

Tabel 6-3

4: ACC / DCC Time 1**5: ACC / DCC Time 2**

Use different combinations of ON/OFF and **ACC / DCC Time** to achieve 4 selections of **ACC / DCC Time**. See Table 6-4 please:

ACC / DCC Time 2	ACC / DCC Time 1	ACC / DCC Time
OFF	OFF	1
OFF	ON	2
ON	OFF	3
ON	ON	4

Table 6-4

6: Frequency Source Selection 1**7: Frequency Source Selection 2****8: Frequency Source Selection 3**

When frequency input source is set to external terminals (P0.01=8), inverter frequency source preset is determined by above three terminals. For details, see please Table 6-1.

9: Jog Forward

It is used to run jog forward in external terminals control status.

10: Jog Reverse

It is used to run jog reverse in external terminals control status.

Jog forward is prior to jog reverse and only jog forward is valid when both are in closing status simultaneously.

11: Coast to Stop

It is applicable for coast to stop in external terminals control status. When closing, inverter will coast to stop, when opening, it will start from speed tracking.

12: Frequency Up Command

It is used to increase frequency.

13: Frequency Down Command

It is used to decrease frequency.

14: External Fault Input (Opening status, valid when Closing)

Using this terminal to input fault signals of external devices, it will be easier for fault control of these devices.

15: 3-Wire Control

When P0.04=1 and terminals Control Mode is 3-wire control mode, this parameter will set this external terminal as inverter stop trigger switch. For reasons, please refer to description of P4.06.

16: DC Braking Command

In the stopping status, if this parameter defined terminal is closing, namely output frequency is lower than DC braking frequency before start, it will run DC braking command to achieve opening the terminal. For details, please refer to description of P2.12-P2.14

17: Counter 0 Reset Input

It is used to reset 0 of built-in counter, and can be used together with function 18.

18: Counter Trigger Signal Input

It is the built-in pulse input port of counter.

19: External Pulse Input

This terminal receives external pulse signal to preset frequency. For details, please refer to parameters group P5.04 and P5.05.

Notice:

1. Function 18 and 19 are only enabled by DI6.
2. Maximum frequency of input pulse is 20KHz, Voltage is lower level 0V, upper level 18~26V.

20: Reset Fault (RESET)

When inverter malfunctions, it can be used to reset fault. This function is same as function of STOP/RESET.

21: UP/DOWN Frequency Terminal 0 Reset

When frequency preset source selection can be set to valid UP/DOWN, User can use UP/DOWN to reset current running frequency to 0.

22: PID

When PID run command is set to valid terminal, PID is enabled only when terminal is enabled.

23: PLC

When PLC run command is set to valid terminal PLC is enabled only when terminal is enabled.

24: Traverse Operation

When traverse run command is set to terminal valid, traverse operation is enabled only when terminal is enabled.

25: Reset Traverse Operation

When run the traverse operation automatically or by hand, closing this terminal will reset all traverse records. Then open the terminal, will restart traverse operation.

26: External Stop Command

This Command is valid for all run commands. When it is valid, inverter will stop in the selected mode of P2.11.

27: Inverter Running Inhibit Command

When this terminal is enabled, running inverter will coast to stop. It is forbidden to start during stand-by. It is suitable for application which requires safe linkage.

28: Inverter ACC / DCC Inhibit Command

It is used to maintain current running speed despite of external signal interferences(except for stop command).

29: Switch between Running Command and Terminal Command

It is used to achieve switch from running command source to external terminal source. When closing the terminal, it will be restored to previous running command source.

30: Switch between Frequency Source Command and AI2

It is used to achieve switch from frequency preset source to AI2 preset. When closing the terminal, it will be restored to previous frequency preset source.

P4.06	FWD/REV Control Mode	Factory Setting	0
	Setting range	0	2-Wire Control Mode 1
		1	2-Wire Control Mode 2
		2	3-Wire Control Mode 1

		3	3-Wire Control Mode 2(Reserved)
--	--	---	---------------------------------

0: 2-Wire Control Mode 1

Please see Figure 6-11 (Default mode):

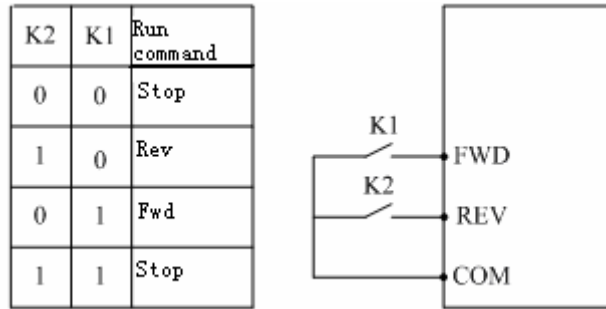

Figure 6-11 2-Wire Control Mode 1

1: 2-Wire Control Mode 1

Please see Figure 6-12:

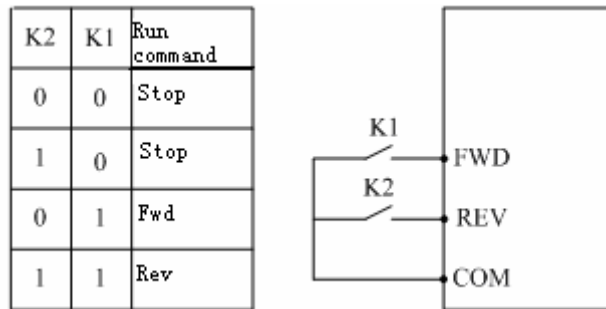

Figure 6-12 2-Wire Control Mode 2

2: 3-Wire Control Mode 1

Please see Figure 6-13 as below. Terminal DIi is the 3-wire control mode terminal of DI1 to DI6.

SB2—Forward run button(Opening)

SB1—Stop button (Closing)

SB3—Reverse run button(Opening)

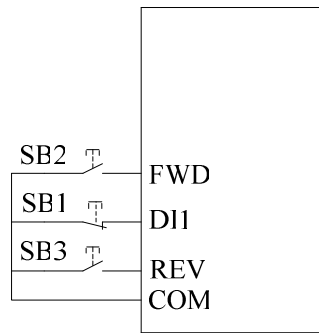

Fig. 6-13 3-wire control mode 1

3 line control model 2

3 line control model 2(fig.6-14). DI1 is operating control terminal of 3-wire type. To select any of the input terminal among DI1-DI6.

SB2- operating switch(normally open)

SB1- stop switch(normally closed)

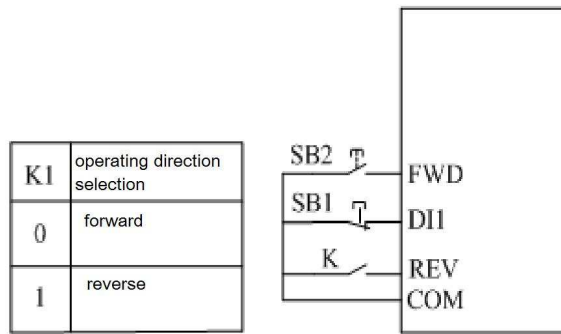

Fig.6-14 3-wire type control mode 2

P4.07	open-circuit collector input terminal DO1 setting	factory default	0
P4.08	open-circuit collector input terminal DO2 setting	Factory default	1
P4.09	programmable relay output	Factory default	15
	setting range	0-15 (please find below description for details)	

0: Operation status indication of inverter.

When inverter is in the status of operation, effective signal will be output; otherwise, non-effective signal will be output.

1: frequency/speed arrival signal(FAR)

Please see description in constant P4.12

2: frequency/speed level detection signal (FDT)

Please see description in constant P4.12

3: frequency zero-speed operation indication

It refers to the output signal when the inverter is in the status of operation, but output frequency is 0.00Hz

4: halt in the event of exterior equipment's fault.

During the operation of inverter, when the switch value input terminal receives exterior equipment fault signal, the inverter will be stopped and the corresponding signal will be output.

5: output frequency reaches upper limit.

This is the signal output when the operation frequency reaches up limit.

6: output frequency reaches lower limit.

This is the signal output when the operation frequency reaches lower limit.

7: one operation period of programmable multi-step speed ends.

When one period of PLC operation ends, this terminal will output the relative signal. (single pulse signal, signal width 500mS)

8: inverter overload alarm signal

In the event that the output current exceeds the overload alarm level, the alarm signal will be output after the set alarm delay time.

9: inverter is power on

When the inverter is power on without fault, the bus voltage is in a normal status, the prohibition function of terminal operation is ineffective, and operation command start is acceptable, then the corresponding signal will be output.

10: counter detection signal output.

Please see the description in constant P4.16

11: counter reset signal output

Please see the description in constant P4.15.

12: inverter fault

When the inverter's operation stopped at fault, the effective signal will be output, i.e. low level. Normally it is a status of high impedance.

13: under-voltage lockout outage

When the DC bus voltage is lower than the permitted voltage level, the corresponding

signal will be output, meanwhile, *POFF* will be displayed.

14: upper and lower limit of transverse frequency

In the course of transverse operation, when the frequency fluctuation to the center frequency is beyond the upper limit P 0.06 and lower limit P0.07, the corresponding frequency will be output.

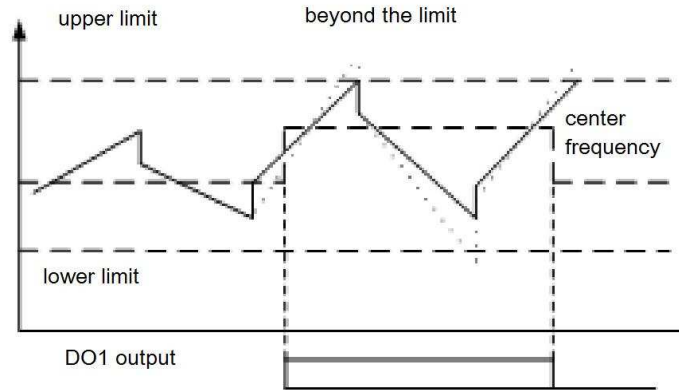

Fig 6-15 transverse operation upper and lower limit schematic

15: programmable multi-step speed staged operation ends.

A effective pulse signal will be output when the current stage operation of PLC ends. The signal width is 500mS.

Note: D1, D2 output effective signal is low level (but the power supply should be increased to be 24 by resistor).

P4.10	FDT level setting	factory default factory default	0.00Hz
	setting range setting range	0.00Hz— upper limit frequency	

P4.11	FDT Delay Value	factory default Factory setting	1.00Hz
	setting range Setting	0.00Hz—30.00Hz	

This group of constant will be used to set frequency detection level. When output frequency rises and exceeds the setting of FDT, open-circuit collector signal will be output, when output frequency declines to be lower than FDT delayed value, the output will be high-impedance state. Please see fig.6-16.

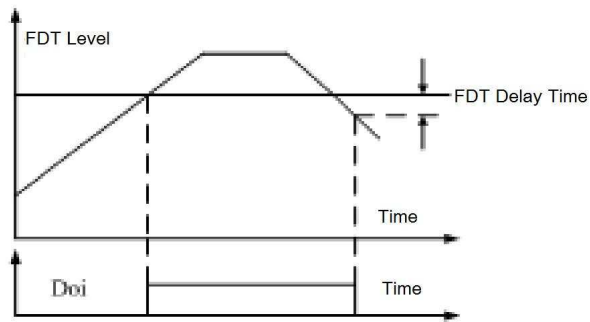

Fig 6-16 FDT Setting Illustration

P4.12	frequency arrives FAR detection width	factory default	0.00Hz
	setting range Setting range	0.00—15.00Hz	

When inverter's output frequency is within the detection range, the selected output

terminal will output open-circuit collector signal, see fig.6-17.

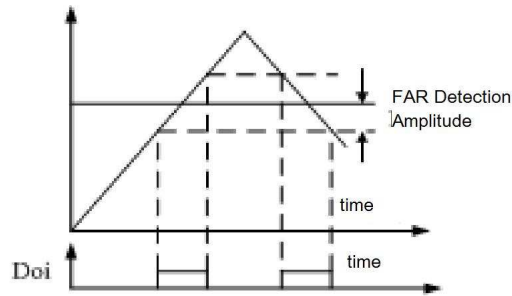

Fig 6-17 FAR Setting Description

P4.13	overload pre-alarm level	factory default	100%
	setting range	20—120%	
P4.14	overload pre-alarm delay	factory default	1.0S
	setting range	0.0~15.0s	

Overload pre-alarm level defines the current threshold of overload pre-alarm operation. The setting range is a percentage of rated current with rated current taken as 100%. Normally overload pre-alarm level's setting should be lower than the thermorelay protection level. When the output current comes to the overload pre-alarm level and the dwelling time is longer than the set olverload pre-alarm delay time, the over-load pre-alarm will act.

P4.15	Counter reset value setting	factory default	1
	setting	0—9999	
P4.16	counter detection value setting	factory default	1
	setting	0—F4.15	

This group of constants define the counter's work, the clock terminal of counter is input via exterior terminal X6. When the counter's count value to the exterior clock reaches the defined value in P4.15, the corresponding multi-functional output terminal (counter reset signal output) will output a signal with its width equal to the exterior effective signal period and the counter's value will come back to Zero.

When the counter's counting value reaches to the value defined in P4.16, the corresponding multi-functional output terminal (counter detection signal output) will output effective signal. If the counter continues to count and the value exceeds the set value in constant P4.15, the counter will come back to zero and the signal will be withdrawn.

As illustrated in below Fig., DO1 was set as reset signal output, DO2 was set as detection signal output, P4.15 was set as 8. P4.16 was set as 5.

When rising to 5, DO2 will output a constant open-circuit signal of collector. When rising to reset value 8, DO1 will output a pulse period open-circuit signal of collector and reset the count value to be zero. At the same time, DO1, DO2's output signal will be withdrawn.

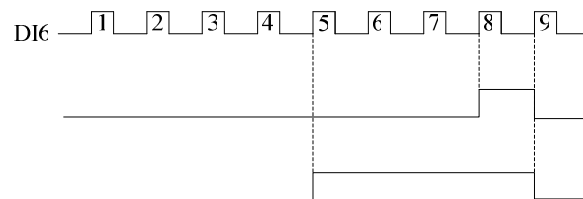

Fig. 6-18 counter reset value setting and counter detection value setting scheme.

6.6: analog input and output constant group.

P5.00	AI1 input lower-limit voltage	factory default	0.0V
	setting range	0.0—F5.01	
P5.01	AI1 input upper-limit voltage	factory default	10.0V
	setting range	P5.00—10.0V	

The above constant defines the range of analog voltage channel AI1. It should be set according to the actual situation of input signal.

P5.02	AI2 input lower-limit current	factory default	0.0mA
	setting range	0.0—P5.03	
P5.03	AI2 input upper-limit current	factory default	20.0mA
	setting range	P5.02—20.0mA	

The above constants define the range of analog current channel AI2, it should be set according to the actual input signal.

Note:

Normally, AI2 port is for current input. But if necessary, it can also be used as voltage input port. It can be selected by the wire jumper JP1 on the control board. The mathematic correspondence between them is that each 20.0mA is equal to 10.0V.

P5.04	exterior pulse input lower-limit frequency	factory default	0.0kHz
	setting range	0.0—P5.05	
P5.05	Exterior pulse input upper-limit frequency	factory default	10.0kHz
	setting range	P5.04—20.0KHz	

The above constants define the frequency range of exterior pulse signal.

P5.06	frequency setting for min. input	factory default	0.00Hz
	setting range	0.0Hz—upper limit frequency	
P5.07	Frequency setting for max. input	factory default	50.00Hz
	setting range	0.0Hz— upper-limit frequency	

This group of constants are used to set the correspondence between exterior input value and frequency setting value. After the frequency setting signal is accepted the disposal of filtering and gain, its correspondence with frequency setting is described as below fig. Either of the two kinds of signal can independently achieve the characteristics of forward operation and reverse operation. Fmax and fmin is respectively the corresponding frequency for mx. input analog and the corresponding frequency for min. input.

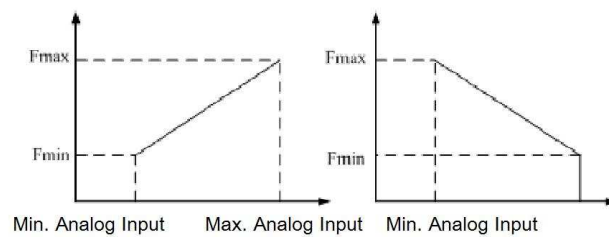

Fig.6-19 The corresponding frequency setting value of Max. and Min. Analog input

P5.08	Analog input signal delay time	factory default	0.5s
	setting	0.1—5.0s	

This constant will implement disposal of filtering on AI1,AI2 and the input signal of keyboard potentiometer according to the set delay time in order to eliminate the influence of disturbing signal. Nevertheless the too long delay time will reduce the response time of the set signal.

P5.09	AO1 multi-functional analog output terminal function selection	factory default	0
P5.10	DO3 multi-functional pulse output terminal function selection	factory default	2
setting range	0	output frequency	
	1	frequency setting	
	2	output current	
	3	motor speed	
	4	output voltage	
	5	bus voltage	
	6	PID set value	
	7	PID feedback value	

AO1 is multifunctional analog value output terminal ,DO3 is multifunctional pulse output terminal, the function setting is as follows:

0: output frequency

Analog output amplitude or pulse output frequency is proportional to the inverter's output frequency.

AO1: (0-AO1 upper limit value) ~ (0.00- upper limit frequency)

DO3: (0-DO3 upper limit value) ~ (0.00-upper limit frequency)

1: frequency setting.

Analog output width or pulse output frequency is proportional to the set frequency.

DO3: (0-DO3 upper limit)-(0.00- set frequency)

2: output current

Analog output width or pulse output frequency is proportional to the output current of inverter.

3: motor speed

Analog output width or pulse output frequency is proportional to the motor speed of inverter

AO1: (0-AO1 upper limit)-(0-motor's synchronous speed)

DO3: (0-DO3 upper limit)-(0-motor's synchronous speed)

4: output voltage

Analog output width or pulse output frequency is proportional to the bus voltage of inverter.

AO1: (0-AO1 upper limit)-(0-max./rated output voltage)

DO3: (0-DO3 upper limit)-(0-max./rated output voltage)

5: bus voltage

Analog output width or pulse output frequency is proportional to the bus voltage of inverter

AO1: (0-AO1 upper limit)-(0-800V)

DO3⊗0-DO3 upper limit)-(0-800V)

6: PID set value

Analog output amplitude or pulse output frequency is proportional to the set value of PID.

AO1: (0- AO1upper limit value) ~ (0.00-10.00V)

DO3: (0- DO3upper limit value) ~ (0.00-10.00V)

7:PID feedback value

Analog output width or pulse output frequency is proportional to PID feedback value.

AO1: (0- AO1 upper limit) ~ (0.00-10.00V)

DO3: (0- DO3 upper limit) ~ (0.00-10.00V)

P5.11	AO1 1 gain setting	factory default	100%
--------------	---------------------------	------------------------	-------------

	setting	20—200%		
P5.13	DO3 gain setting	factory default	100%	
	setting	20—200%		
P5.12	disabled			
P5.14	disabled			

Contant P5.11 defines the upper limit value of analog output AO2, when the factory default is 100% and output voltage/current's range is 0-10V/0-20mA, voltage and current output will be selected by JP2 jumper.

Contant P5.13 defines the upper limit of pulse output DO3, when the factory default vaule is 100%, output frequency range is 0-10KHz.

$AO1output=(0-10V/0-20mA) \times AO1 \text{ gain setting}$ (the max. value will not bigger than 10V/20 mA)

$DO3output=(0-10 \text{ KHz}) \times DO3 \text{ gain setting(Max.20 KHz)}$

P5.15	combination setting	given channel	factory default	000
	setting	000—666		

LED units: operand 1

- 0: keyboard potentiometer
- 1: digital setting
- 2: disabled
- 3: communication setting
- 4: AI1
- 5: AI2
- 6: terminal pulse

LED tens: operand 2

- 0: keyboard potentiomete
- 1: digital setting 1
- 2: disabled
- 3: communication setting
- 4: AI1

5: AI2
6 :terminal pulse

LED hundreds: operand 3

0: keyboard potentiometer
1: digital setting 1
2: disabled
3: communication setting
4: AI1
5: AI2
6 :terminal pulse

LED thousands: disabled

P5.16	combination given arithmetic setting	factory default	00
	setting	00—54	

LED units: arithmetic 1

0: plus
1: minus
2: absolute value (subtraction)
3: to select the max. value
4: to select the min. value

LED tens: arithmetic 2

0: 加 1: minus
2: absolute value (subtraction)
3: to select the max. value
4: to select the min. value
5: operand. 3 will not participate in operation.

LED hundreds: disabled**LED thousands: disabled**

Note:only when P0.01=7,P5.15,P4.16 are effective.

P5.15, P5.16 define that when P0.01=7, the operational formula between every analog

and digital input value is :

(operand 1)arithmetic 1(operand 2) arithmetic 2 (operand no.3)

If set the tens of P5.16's LED to be 5, operand 3 will not participate in operation, it will be operational combination with two operands(operands1 and operand 2)

Case 1:

If P5.15 is set to be 531 while P5.16 is set to be 10, the operational combination will be: $\{(\text{digital setting } 1 + \text{communication setting}) - \text{AI2}\}$

Case 2:

When P5.15 is set to be 410 and P5.16 is set to be 21, the operational combination will be: $|\text{(keyboard potentiometer value} - \text{digital set value)} - \text{AI1}|$

note:

Arithmetic rule 1: in any case, the operation sequence will be that operand 1 operates with operand 2 according to arithmetic 1, the result 1 operates with operand 3 according to arithmetic 2, then the final result will come out. If the operational result 1 of the former 2 digits is minus, this minus digit will be 0 by default

6.7 process PID control constant

Analog feedback control system:

Pressure set value is given by AI1. Put the pressure sensor's feedback value(4-20mA) to AI2. Then it will go to the built-in PID. Hence an analog closed-loop control system comes into being. (fig.6-20)

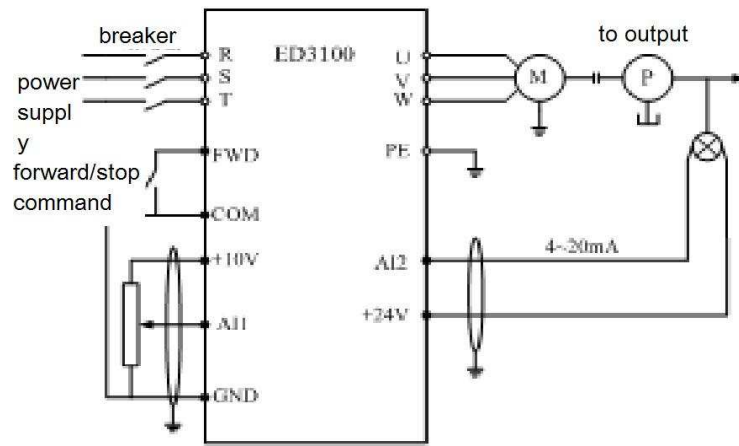

Fig.6-20 analog feedback control system schematic

P6.00	PID operation setting	factory default	00
	setting range	00-11	

LED units; function setup

0: close

1: open

LED tens: PID switch selection

0: automatic switch

1: manual switch by defined multi-functional terminal

LED hundreds: disabled

LED thousands: disabled

PID control function:

PID controller adjusts the output frequency through performing proportional, integral and differential operation on the difference value between the system's preset value and the feedback value detected by the sensor of controlled object. This adjustment stops until the difference value is 0. The system structure is illustrated in 6.21

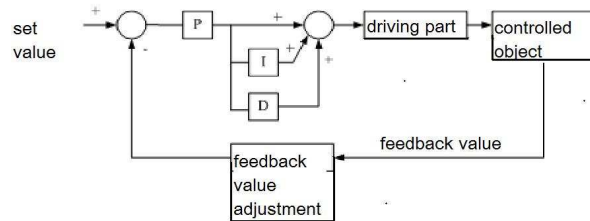

Fig. 6-21 PID system structure

P6.01	PID setting channel selection	factory	1
	setting range	0	keyboard potentiometer setting
		1	digital setting
		2	disabled
		3	disabled
		4	AI1 setting
		5	AI2 setting

		6	Terminal pulse
		7	AI1+AI2
		8	AI1-AI2
		9	MIN {AI1,AI2}
		10	MAX {AI1,AI2}

0: keyboard potentiometer setting

PID set value is decided by the potentiometer in the operation panel.

1: digital setting

PID set value is decided by digits, and set through constant P6.03.

2: disabled

3: disabled

4: AI1 setting

PID set value is given by exterior voltage signal AI1(0-10V)

5: AI2 setting

PID set value is given by exterior current signal AI2 (0~20mA/0~10V)

6:terminal pulse

PID set value is defined by exterior pulse

7: AI1+AI2

Algebraic summation of AI1 and AI2

8: AI1-AI2

The difference between AI1 and AI2. If AI1 is less than or equal to AI2, the result will be 0.

9: MIN {AI1,AI2}

The smaller one between AI1 and AI2.

10: MAX {AI1,AI2}

The bigger one between AI1 and AI2

P6.02	feedback channel selection	factory	4
	setting range	4	AI1
		5	AI2
		6	Terminal pulse
		7	AI1+AI2
		8	AI1-AI2

		9	MIN { AI1,AI2 }
		10	MAX { AI1,AI2 }

Note: the setting channel and feedback channel shall not be same, otherwise the set value and feedback value will be exactly same, and the difference is 0, in this case, PID can't work in a normal state. Besides, the feedback channel selection shall not be set within 0-3, otherwise, it makes no sense.

P6.03	the setting of preset digital value	factory default	0.00V
	setting	0.00—10.00V	

In the case that PID setting channel select the mode of digital setting, this constant are used to set PID's preset digital value.

In the closed-loop control system of constant pressure water supply, the setting of this constant should sufficiently consider the relation between remote-transmission gauge and its feedback signal. For instance, the measuring range of the gauge is 0-10Mpa, the voltage output, 0-10V(0-20mA), needs pressure, 6 Mpa. Then the preset digital value can be set as 6.00V, then the pressure will be 6 Mpa after the PID's adjustment.

P6.04	feedback channel gain	factory default	1.00V
	setting	0.01—10.00	

When feedback channel is different from the set channel level, this constant can perform gain adjustment on feedback signal.

P6.05	feedback channel polarity	factory default	0
	setting	0	positive characteristics
	range	1	Negative characteristics

0: positive characteristics

When feedback signal is bigger than PID set value, to make the PID to be in a balance state requires to reduce the inverter's output frequency(i.e to reduce the feedback signal). For example, the control of rewinding tension and constant pressure water

supply.

1: negative characteristics

When feedback signal is bigger than PID set value, the balance of PID requires inverter's output frequency to be increased(i.e. to reduce feedback signal)

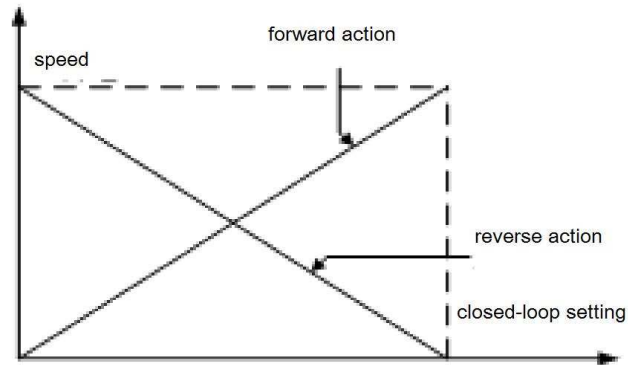

Fig. 6-22 forward/reverse characteristics illustration

P6.06	Proportional gain P	factory	1.00
	setting	0.01—10.00	
P6.07	integral time Ti	factory	1.00s
	setting	0.1—200.0s	
P6.08	differential time Td	factory	0.0s
	setting	0.0—10.0s	

The constants of Built-in PID should be set according to the system's characteristics and actual demands.

Proportional gain P: It decides the whole PID's adjustment intensity. The bigger the P is, the stronger the intensity is.

Integral time Ti: To decide PID's integral adjustment time on the deviation of PID's

feedback value from the set value.

Integration time T_d : to decide PID controller's adjustment intensity on the change rate of PID feedback value's deviation from the set value

Note: When $P6.08=0.0$, differential action is non-effective.

P6.09	sampling period T	factory	0.00s
	setting	0.00—10.00s	

PID operates once in each period of system's sampling on feedback PID. If sampling period is long, then the response will be slow, however the suppressing effect will be better. Therefore, this constant should be set according to the actual situation on spot.

Note: when $P6.09=0.00$, sampling ends automatically

P6.10	diviation limit	factory	0.0%
	setting range	0.0—20.0%	

Diviation limit is the ratio of the absolute value of the system's permitted feedback value's diviation from the set value to the set value. When the ratio is lower than the set value of this constant, PID will not operate.

This function is mainly used in the system which has lower requirement on control precision and needs less times to be adjusted. The reasonable setting of this constant is in favor of enhancing the system's output stability.

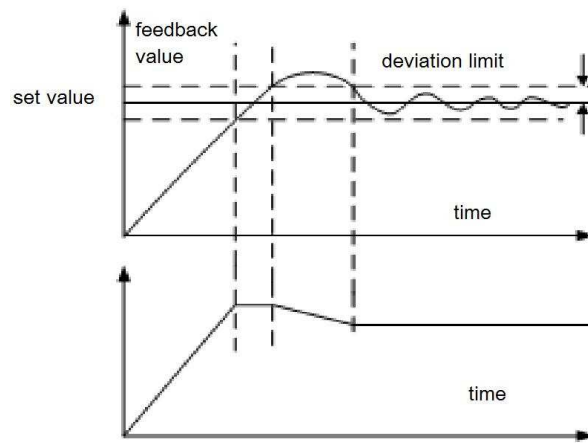

Fig.6-23 deviation limit schematic

P6.11	closed-loop preset frequency	factory	0.00Hz
	setting range	0.0-upper limit frequency	
P6.12	preset frequency dwell time	factory	0.0s
	setting range	0.0—6000.0s	

This constant defines inverter's preoperation frequency and time before the PID is put into operation when PID control is effective. In some control systems, inverter will forcibly output a certain frequency value P5.11 according to this constant's setting until the preste time P6.12. To increase the response speed, PID works only when the controlled subject is approaching to the control target.

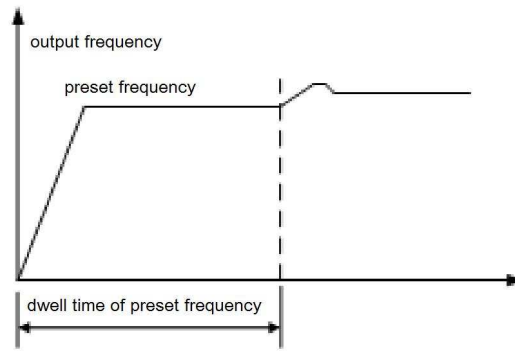

Fig.6-24 closed-loop preset frequency operation schematic

P6.13	sleep threshold	factory default	10.00V
	setting	0.0—10.00V	

This constant defines inverter's feedback limit value of shifting from operating state to sleeping state.

If actual feedback value is bigger than this set value and inverter's output frequency declines to lower limit, inverter will come into sleeping state after about five minutes's delay time.

P6.14	wake threshold	factory default	0.00V
	setting range	0.0—10.00V	

This constant defines the feedback limit value when shifting from sleeping state to operating state.

If the actual feedback value is less than the set value, inverter will shift come out of sleeping state into operating state after five minutes's delay time.

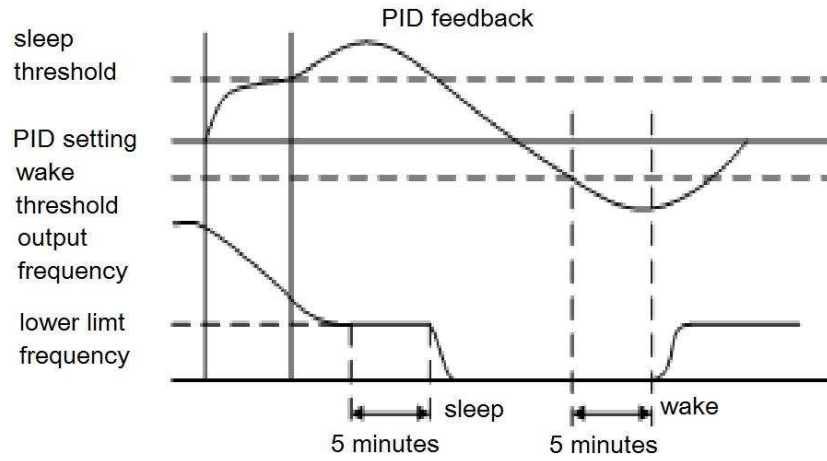

Fig.6-25 sleep and wake function illustration

6.8 PLC operation constant group

P7.00	PLC operation method selection	factory default	000
	setting range	000-114	

LED units; operation method selection

- 0: non-operation
- 1: single cycle(simple PLC)
- 2: continuous cycle(simple PLC)
- 3: dwell on the last value after single cycle(simple PLC)
- 4: transverse operation

LED units; PLC multi-step speed(simple PLC) operation switch method

- 0: automatic
- 1: manual switch by multifunctional terminal.

LED hundreds; transverse operation switch method

- 0: automatic
- 1: manual switch by multifunctional terminal.

LED thousands: disabled

Detailed function explanation of each operation method:

0: non-operation

PLC operation is invalid

1: single cycle

Inverter's multi-step speed operation stops after one cycle ends and it needs another operation command to restart. If a certain stage's operation time is 0, it will be skipped and the operation will go to the next stage. As illustrated in fig. 6-26

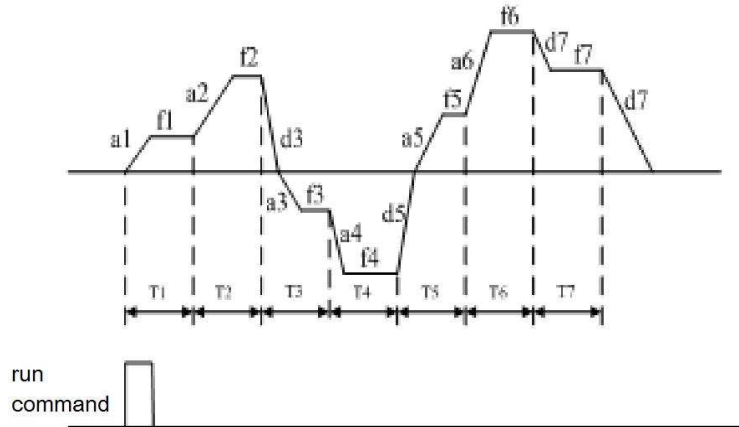

Fig.6-26 single cycle schematic

$f_1 \sim f_7$ are operation frequencies for stage 1 ~ stage 7 respectively;

$T_1 \sim T_7$ are operation time for stage 1 ~ stage 7 respectively;

$a_1 \sim a_6$ are acceleration time for stage 1 ~ stage 6 respectively.;

d_3 , d_5 and d_7 are deceleration time for stage 3, stage 5, stage 7 respectively. .

Note:

Multi-step speed's operation time must be longer than acceleration time, nevertheless, this group of constants only defines the value of operation time. Therefore, it is necessary to know the conversion of multi-step speed's acceleration time.

Multi-step acceleration/deceleration time= { (current multi-step frequency-initial multi-step frequency) /basic operation frequency } × acceleration/deceleration time(P0.14,P0.15)

For example: in the event of multi-step speed operation with basic operation frequency 50Hz,acceleration time 10S, deceleration time 20S, the system's acceleration time from 20Hz to 30Hz will be:

$$T1= \{(30\text{HZ}-20\text{HZ}) /50\text{HZ}\} \times P0.14=2\text{S}$$

The system's deceleration time from 30Hz to 10Hz will be

$$T2= \{(30\text{HZ}-10\text{HZ}) \div 50\text{HZ}\} \times P0.15=8\text{S}$$

2: continuous cycle

Inverter's multi-step speed operation recycles until stop command was input, as illustrated in fig.6-27.

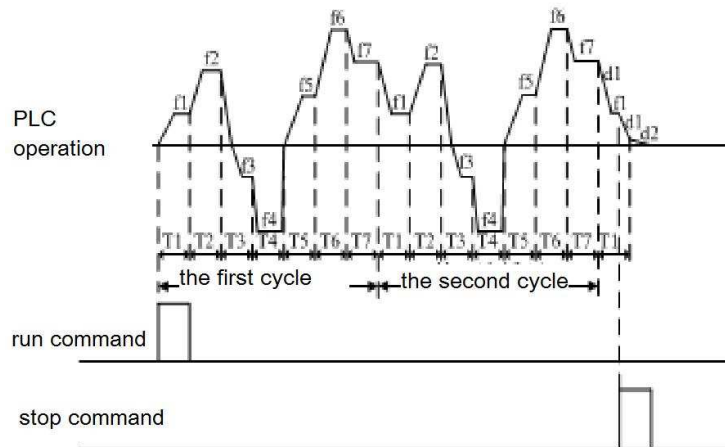

Fig 6-27 recycle illustration

3: the last value dwells after single cycle.

After a single cycle, inverter operates according to the set frequency and operating direction of the multi-step stage where the last operation time is not set as zero. Please see fig. 6-28:

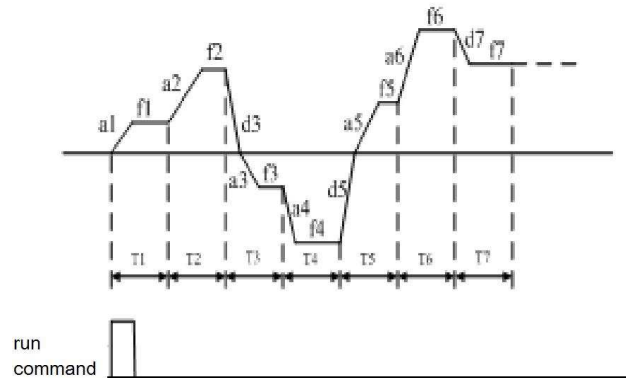

Fig. 6-28 the last value dwells after single cycle

4: wollulation frequency control

Inverter's output frequency changes periodically during the set acceleration /decelleartion time. This function is particularly suitable for textile, fiber and other situation where the speed variation is effected by the different diameters of the barrel.

P7.01	stage 1 operation time	factory default	10.0s
P7.02	stage 2 operation time	factory default	10.0s
P7.03	stage 3 operation time	factory default	10.0s

P7.04	stage 4 operation time	factory default	10.0s
P7.05	stage 5 operation time	factory default	10.0s
P7.06	stage 6 operation time	factory default	10.0s
P7.07	stage 7 operation time	factory default	10.0s
P7.08	disabled		
	setting	0.0—6000.0s	
P7.09	multi-ste operation direcdtion 1	factory default	0000
P7.10	multi-ste operation direcdtion 2	factory default	-000
	setting	0000—1111(0:forward 1:reverse)	

The above constants are used to set the PLC operation time, operation direction and acceleration/deceleration time. These constant are effective only when the PLC operation function is enabled.

PLC operation priority level is higher than the exterior terminal control's multi-step speed.

P7.11	transverse operation method	factory	000
	setting	0000—111	

LED units: disabled

LED tens: oscillation amplitude

0: fixed amplitude

1: fluctuant amplitude

LED hundreds: transverse frequency stop start method selection

0: to start according to the momorized state before stop

1: to start from the initial state

LED thousands: transverse operation state power-cut memory

0: to memorize the transverse operation state after power-cut

。

To automatically recover the state before power-cut and reoperate from the cut-off

1: to not memorize the transverse operation state after power-cut.

To restart transverse operation after inverter's start

P7.12	preset frequency of transverse	factory default	10.00Hz
	setting range	0.00Hz—upper-limit frequency	
P7.13	latency time of preset transverse frequency	factory default	0.0s
	setting range	0.0—3600.0s	

Preset frequency is operation frequency before the inverter shifts to the transverse operation mode or when the inverter shift out of the transverse operation mode. If you select constant P7.00=4, then the inverter goes directly into the operation of preset transverse frequency after start and then goes into the mode of transverse operation after the latency time of woulation preset frequency. When the selection terminal was selected manually, P7.13 is noneffective.

Note:

If P7.11's hundreds is set as 0, the preset transverse frequency will be non-effective when the inverter start operation after transverse operation stop since the system will operate according to the memorized state before stop. If set as 1, the frequency will start from preset frequency of transverse. While P7.11's huanrds will decide whether the transver operation start will memorize the last operating information after each poweron following poweroff. If the memory is effective, whether the first start will begin from the preset transverse frequency depends on P7.11's hundreds. If not memorized, the frist operation aways starts from preset transverse frequency after each poweron. Besides, the reset of transverse frequency state can be achieved by the multi-function terminal which is difiend as transverse operating state rest.

P7.14	transverse amplitude	factory default	10.0%
	setting range	0.0—50.0%	

This constant is referring to the ratio of transverse amplitude.

If you select fixed amplitude, the calculating formula of actual amplitude is:
 Transverse frequency amplitude=P7.14x Upper limit frequency

If you select varied amplitude frequency, the calculating formula of actual amplitude is :

Transverse amplitude=P7.14x(transverse center frequency reference P7.18+the set frequency difined by P0.01)

P7.15	Jump frequency	factory default	0.0%
	setting range	0.0—50.0%	

This constant refers to the rapidly declining amplitude of frequency after it arrives to the upper limit in the course of transverse frequency state, certainly, it also refers to the fast rising amplitude after the frequency declines to the lower limit of transverse frequency.

actual jump frequency=P7.15x Transverse frequency.

P7.16	transverse frequency period	factory default	10.0s
	setting range	0.1—3600.0s	

This constant was used to set a operation period of transverse frequency.

P7.17	triangle rising time	factory default	50.0%
	setting range	0.0—100.0%	

This constant defiteds th operation time when transverse frequency operation goes from the lower limit to the upper limit,ie, the acceleration time of transverse operation period.

Actual triangle rising time=transverse period P7.17

For sure, the difference of transverse period from triangle wave's rising time is the decling time of triangle wave.

P7.18	transverse center frequency	factory default	10.00Hz
	setting range	0.00—upper limit	

This constant refers to the reference value of inverter's output frequency center in the

course of transverse frequency operation

Actual transverse center frequency is the summation of this constant value and the set frequency defined by exterior frequency setting channel P 0.001. i.e.:

Transverse center frequency= $[\mathbf{P7.18}] + \mathbf{P0.01}$ the set frequency of the appointed channel.

note:

The transverse operation frequency is restricted by the upper limit and lower limit frequency. The improper setting will result in abnormal transverse operation.

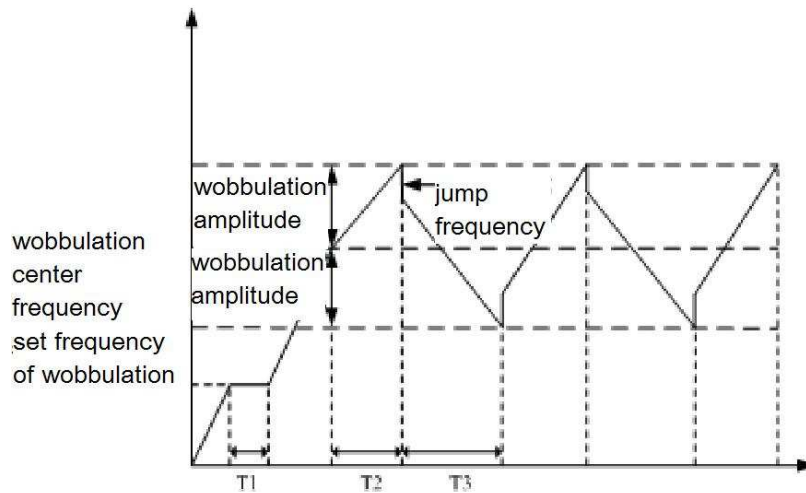

Fig. 6.29 transverse setting illustration

note:

The inverter's frequency setting priority is as following:

Jog operation frequency > transverse operation frequency > set frequency of PID operation > PLC operation frequency > multi-step frequency of multi-function terminal selection > channel selection of frequency setting.

6.9 communication constant group

P3.00	native address:	factory default	1
	setting	0—31	

This constant is used to set the address in the course of inverter's RS485 communication. This address is sole.

0: master station

This means the inverter is master station in the even of sequential control. And it controls the operation of other inverters which connects it.

1-31. slave station

It means this inverter works as passive machine and accepts the data from host machine or the inverter which is in a position of master station.

P3.01	communication configuration	factory default	013
	setting	0000—0125	

This constant defines the baud rate of RS485 communication, all the communicating parts must be set with same baud rate, and it also defines the data format of communication, the all the communication parts must adopt same data format to achieve normal communication.

LED units:**Baud rate setting**

- 0: 1200BPS
- 1: 2400BPS
- 2: 9600BPS
- 3: 9600BPS
- 4: 19200BPS
- 5: 38400BPS

LED tens:**data format**

- 0: no check
- 1: even check
- 2: odd check

LED hundreds:**communication failure operation selection**

- 0: to halt
- 1: to maintain

LED thousands: disabled

P8.02	communication overtime detecting	factory	10.0s
	setting	0.0-100.0s	

If this machine doesn't receive the correct data signal beyond the time interval defined by this constant, the machine will take it as communication failure, and inverter will decide to stop operation or maintain the current state according to the setting of communication failure operation method.

P8.03	the machine's response delay time	factory	5ms
	setting	0-1000ms	

This constant defines that this machine directly send response data frames to the host machine's delay time after receiving correctly the host machine's information codes

P8.04	proportional setting of linked operation	factory default	1.00
	setting	0.01-10.00	

This constant is used to set the weight coefficient of the frequency command which this inverter, as a slave machine, receives from RS485 terminal. This machine's actual operation frequency is the product of this constant and the frequency setting command value received from RS485. In the course of linked operation control, this constant can set the operation frequency's proportion of multiple inverters

6.10 protection constants

P9.00	motor overload protection coefficient	factory default	105%
	setting	30%—110%	

If the inverter's driving power level matches the motor, the motor's protection coefficient can be set to be 100%. In this case, if the output current is less than 150% of the inverter's rated current, the motor's overload protection will not operate. When the output current is equal to 150% of the inverter's rated current, motor's overload protection will not operate either because inverter overload protection will act first. Please see fig. 6-30:

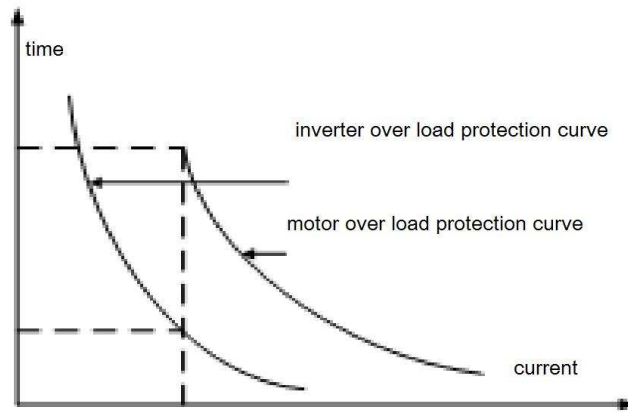

Fig. 6-30 inverter's overload protection and motor's overload protection curve

When inverter's capacity is bigger than the motor's capacity, it is necessary to set motor's overload protection coefficient to perform effect overload protection on the motors with variable loads, as illustrated in fig. 6-31

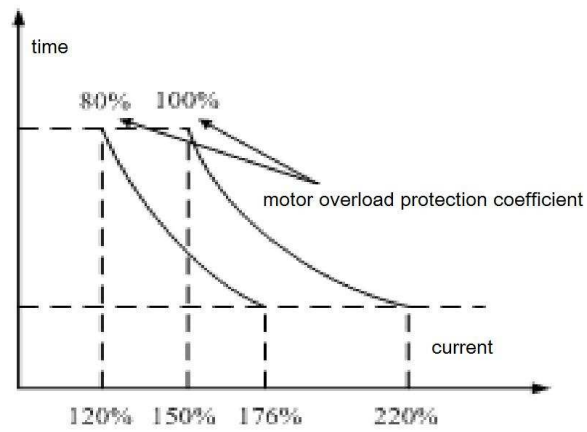

Fig. 6-31 Motor's overload protection efficient setting.

protection efficient is decided by the following formula:

Motor's overload protection efficient=motor's rated current/inverter's rated output current**x100%**

P9.01	under voltage protection level	factory default	400V (380V)
	setting	360V—480V (380V)	220V-240V (220V)

This constant defines the permitted lower-limit voltage of DC bus when inverter works normally.

Note:

When grid voltage is low, the motor's output torque declines. In the situation with constant-power load and constant-torque load, low grid voltage will increase the inveter's input and output current. In this case, the inverter's operation reliability will be reduced. Therefore,the inverter's derating application is necessary in the situation of long time low grid voltage operation.

P9.02	overload restriction level	factory default	700V (380V)
	setting	660—760V (380V)	330-380V (220V)

This constant defines the threshold value of voltage stallout protection during the inverter's deceleration. If inverter's interior DC pumping voltage exceeds the set value of this constant, inverter will adjust the deceleration time to slow down or stop the drop of the output frequency till the bus voltage is lower than the restriction value, as illustratated in fig. 6-32.

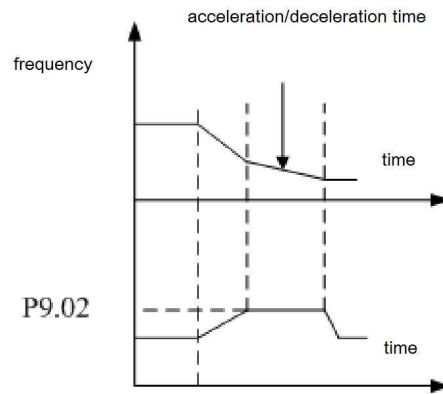

Fig. 6-32 overload restriction level illustration.

P9.03	current amplitude restriction level	factory default	180%
	setting	120%—220%	

During the acceleration, when inverter's output current exceeds the set value of this constant, inverter will automatically adjust acceleration time till the current comes back to be lower than the set value, and then continue to rise to reach the target frequency. In the event of constant-speed operation, when the inverter's output current exceeds the set value of this constant, inverter will adjust the output frequency (frequency reduction unloading) to ensure the current to be within set range and avoid over-current trip.

6.11 advanced function constants

PA.00	zero frequency operating threshold	factory default	0.00Hz
	setting	0.00—50.00Hz	
PA.01	zero-frequency return difference	factory default	0.00Hz
	setting	0.00—50.00Hz	

This constant defines the frequency ZCP(zero crossing point) characteristics

When the frequency is set by analog signal, normally the signal's fluctuation will disturb the output of the inverter. This constant's delay function can avoid the fluctuation nearby zero point.

The following is an example with analog voltage input channel AI1:

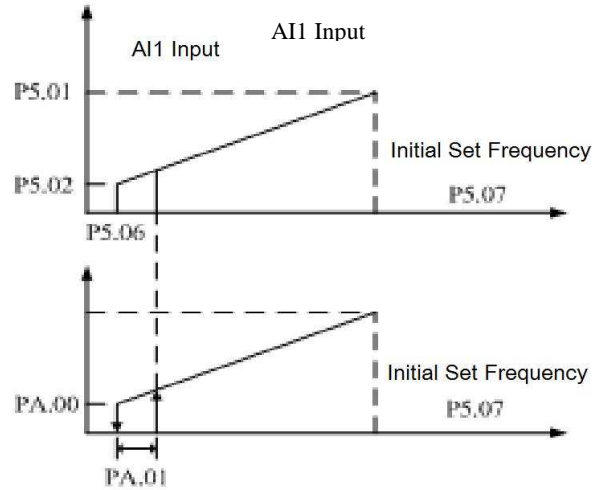

Fig 6-33 Zero frequency retrun difference operation

When the operation command is released, if the above constant(PA.00、PA.01) are not set, the output frequency will be output strictly according to the correspondence between analog voltage and frequency. When operation is started with set PA.00、

PA.01, if the VII's set value is smaller than PA.00+ PA.01, the inverter will not operate. When the corresponding frequency of AI1 exceeds PA.00+ PA.01, the motor starts and accelerate according to the preset accelerating time until it reaches AI1's corresponding frequency..

During deceleration, when the frequency arrives to PA.01, the inveter won't stop. It stops only when AI1's corresponding set frequency arrives to or lower than PA.00

This function can achieve sleep function of inverter.

PA.02	energy-consumption braking start voltage		factory default	740V
	setting	600—750V		
PA.03	energy-consumption braking action ratio		factory default	50%
	setting	10—100%		

This constant group are used to define the action parameters of inverter's built-in barking unit. If inverter's interior DC voltage is higher than start voltage of energy consumption braking, the built-in unit will act. In this case,if the braking resistor is connected, the reduction of DC voltage will be achieved by releasing the puming voltage energy of inverter's interior current via baking resistor. When DC side voltage comes down to a certain value, inverter's built-in braking unit will be closed.

Energy consumption braking action ratio is used to define the average voltage implemented on the braking resistor in the course of barking unit's action.

PA.04	cooling fan control		factory	0
	setting	0	auto control mode	
	range	1	continuous operation when the power is on	

0: auto control mode

It runs continuously during the operation of inverter

The fan stops when the inverter stops operation and the detected temperature of heat sink is below 40 centigrade

1: continuous operation when the power is on

This mode is only applicable in the event that some of the fans cann't stop wrok.

PA.05	UP/DOWN terminal modifying rate	factory default	1.00Hz/S
	setting range	0.01Hz~100.0Hz/S	

To modify the value of this constant can adjust the frequency's rise and fall speed when the frequency is controlled by UP/DOWN terminal

PA.06	overmodulation function	Factory default	0
	setting	0	prohibited
	range	1	allowed

When PWM works in the condition that modulation ratio is less than 1, this function can increase the inverter's output voltage for higher torque output. Nevertheless, this function will increase the harmonics of the output voltage and destroy the current wave. When the grid voltage is kept in a low situation for a long time(lower than 15% of the rated voltage), or the motor's output torque under the control of inverter is lower than the output torque of grid frequency operation,such as long time heavy load operation, you can use this function.

Chapter 7 Troubleshooting

7.1 Failure and countermeasure

When the inverter occurs abnormality, LED digitron will display the function code and information about corresponding fault, fault relay will operate and inverter will stop outputting, when the fault occurs, in case that the motor still rotates, it will perform free stop, till it stops rotating. The permissible fault of ED3100 series is shown as table 7-1, the fault code display range is Er00-Er18. When finding the fault of inverter, user shall examine according to this table first and record the symptom in detail, and may contact our after-sale service center or our sales agencies if need technical service.

7.2 Enquiry of fault record

This series of inverters keeps the code of latest four times faults and the inverter operating parameters of the last fault, to help user to enquire these information that is good for finding the fault reason. All fault information is stored in group D19-D27 parameters; user can refer to the keyboard operating method to enter into group b for inquiring the required information.

7.3 Fault reset

Please choose following any operation if requiring the fault inverter to recover normal running.

- (1) When the inverter displays the fault code, you can press  key to reset.
- (2) When any one terminal of D11~D16 has been set to external RESET input (P4. 00~P4. 05=20), it can break after closing with COM terminal
- (3) Cut off power supply.



Warning:

- (1) Prior to resetting, user must find the fault reason thoroughly and remove the fault; otherwise, it would result in irremediable defect of inverter.
- (2) User shall find the reason if the inverter can't reset or it reoccurs the fault after resetting; otherwise, the consecutive resetting would cause the damage of inverter.

(3) After delaying 5 min, the inverter can be reset when it performs the operation of overload and overheating protection.

Fault code	Fault name	Possible cause	Solution
Er00	Over current at accelerating operation	<ul style="list-style-type: none"> ① Too short accelerating time ② Ultra large load inertia. ③ Unsuitable V/F curve ④ Ultra low main voltage ⑤ Too small inverter power ⑥ Restart the rotating motor 	<ul style="list-style-type: none"> ① Extend accelerating time ② Reduce the load inertia ③ Reduce torque boost value or adjust V/F curve ④ Examine input power supply ⑤ Choose the inverter of large power ⑥ Set the speed-detection start function
Er01	Over current at decelerating operation	<ul style="list-style-type: none"> ① Too short decelerating time ② Ultra large load inertia. ③ Too small inverter power 	<ul style="list-style-type: none"> ① Extend decelerating time ② Reduce the load inertia ③ Choose the inverter of large power
Er02	Over current at constant speed operation	<ul style="list-style-type: none"> ① Abnormal input voltage ② Load occurs abrupt change or abnormality ③ Too small inverter power 	<ul style="list-style-type: none"> ① Examine input power ② Examine load or reduce the abrupt change of load ③ Choose the inverter of large power
Er03	Over voltage at accelerating operation	<ul style="list-style-type: none"> ① Abnormal input voltage ② Restart the rotating motor 	<ul style="list-style-type: none"> ① Examine input power ② Set the speed-detection start function
Er04	Over voltage at decelerating operation	<ul style="list-style-type: none"> ① Too short decelerating time ② There is energy -feedback load ③ Abnormal input power supply 	<ul style="list-style-type: none"> ① Extend decelerating time ② Add braking power of external energy-consumption braking unit ③ Examine input power
Er05	Over voltage at constant speed operation	<ul style="list-style-type: none"> ① Abnormal input voltage ② Ultra large load inertia. 	<ul style="list-style-type: none"> ① Examine input power ② Choose energy-consumption

			braking unit
Er06	Over voltage at stopping	①Abnormal input supply voltage	①Examine input supply voltage
Er07	Under voltage at operating	① Abnormal input voltage	① Examine supply voltage
Er08	Phase failure of input power	①Input power occurs phase failure or abnormality	① Examine input power
Er09	Module fault	① Inverter outputs short circuit or earthes ② Instant over current of inverter ③ Too high environment temperature ④ Air flue is blocked or fan is damaged ⑤ DC auxiliary power supply occurs fault ⑥ Abnormal control panel	① Examine the connecting wire; ② Refer to solution against over current ③ Reduce environment temperature ④ Clean the air flue or change the fan; ⑤ Ask for service from manufacturer or agency. ⑥ Ask for service from manufacturer or agency.
Er10	Over heat radiator	① Too high environment temperature ② Fan is damaged ③ Flue is blocked	① Lower environment temperature ② Change the fan ③ Clean the flue and change the ventilation condition;
Er11	Overload of inverter	① Too high torque boost or unsuitable V/F curve ② Too short accelerating time ③ Too large load	① Reduce the torque boost and adjust the V/F curve. ② Extend accelerating time ③ Reduce load or choose the inverter of large power
Er12	Overload of motor	① Too high torque boost or unsuitable V/F curve ② Too low main voltage ③ Locked rotor of motor or too large abrupt change of load ④ Incorrect setting of motor overload protection factor	① Reduce the torque boost value or adjust the V/F curve. ② Examine main voltage ③ Examine load ④ Set the motor overload protection factor correctly
Er13	Fault of external	① Fault input terminal of external equipment closes	① Open the fault input terminal and remove the fault.

	equipment		
Er14	Fault of serial port communication	① Improper setting of baud rate ② False of serial port communication ③ Without upper machine communication signal	① Set baud rate correctly ② Examine communication cable and ask for service ③ Check whether the upper machine works and the connection is correct.
Er15	Reserved		
Er16	Incorrect current detection	① The current detecting device is damaged or the circuit occurs fault ② DC auxiliary power is damaged	① Ask for service from manufacturer or agency.. ② Ask for service from manufacturer or agency..
Er17	Fault of communication between keyboard and control panel	① The circuit connecting keyboard and control panel occurs fault ② The terminal is poor in connecting	① Ask for service ② Examine and reconnect
Er18	System fault	Quite serious inference and false program reading	Ask for service from manufacturer or agency..

7-1 Table of fault code and solution

Chapter 8 Maintenance

8.1 Maintenance

In case of change of service environment for inverter, such as temperature, humidity, smog and aging of inverter internal parts, the inverter fault may occur. Therefore, the inverter must be examined daily and given the regular maintenance in period of storing and using.

8.1.1 Daily maintenance

When the inverter is turned on normally, please make sure the following items:

- (1) Whether the motor has abnormal noise and vibration.
- (2) Whether inverter and motor heat or occur abnormality.
- (3) Whether environment temperature is too high.
- (4) Whether the value of load ammeter is in conformity with the former.
- (5) Whether the fan of inverter rotates normally.

8.2 Regular maintenance

8.2.1 Regular maintenance

Before the inverter is maintained and checked, the power supply must be cut off, in addition, the monitor shall have no display and main circuit power indicator lamp goes out. The examined content is shown as table 8-1.

8.2.2 Regular maintenance

In order to make the inverter run normally for a long time, the electronic elements mounted in inverter shall be maintained regularly. And the service life of electronic elements is different with the service environment and service condition. The maintenance period of inverter as shown in the table 8-2 is provided for referring.

Table 8-1 Regular examined contents

Item	Content	Solution
Screw of main circuit terminal and control circuit	Whether the screw is slack	Tightened by screwdriver
Heat sink	Whether there is dust on it	Blow it away with the dry compressed air of 4~6kg/cm ² pressure
PCB (Printed circuit board)	Whether there is dust or vapor on it	Blow it away with the dry compressed air of 4~6kg/cm ² pressure or dry it with the hot air.
Fan	Whether it runs normally and makes abnormal sound or vibration, and whether the accumulated time runs up to more than 20000hours.	Change the fan

Power unit	Whether there is dust on it	Blow it away with the dry compressed air of 4~6kgcm ² pressure
Aluminum electrolytic capacitor	Whether it has color change, peculiar smell, bubbling, liquid leakage.	Change the aluminum electrolytic capacitor

Table 8-2 Changing time of inverter parts

Part name	Standard changing time
Fan	2~3 years
Electrolytic capacitor	4~5 years
PCB	5~8 years
Fuse	10 years

Applicable condition for changing time of aforementioned inverter parts

- (1) Environment temperature: Annual average is 30°C.
- (2) Load factor: Less than 80%
- (3) Running time: Less than 12 hours every day

8.3 Warranty of inverter

If the inverter has the following situation, we can provide the warranty service.

- (1) The range of warranty only refers to the body of inverter
- (2) When normally used, the inverter occurs fault or is damaged within 12 months, we will be responsible for warranty; if exceeding 12months, we will charge the reasonable maintenance fee.
- (3) Within 12 months, if the following situations occur, we also charge the reasonable maintenance fee;
 - The inverter is damaged for that user doesn't refer to the operating manual.
 - The inverter is damaged by reason of flood, fire, abnormality of voltage, etc.
 - The inverter is damaged by reason of false connection.
 - The inverter is damaged for that it is used for the abnormal purpose.
- (4) The relevant service fee is calculated according to actual cost. If a contract has been set, we refer to the contract first for handling.