

VFD-A/H *User Manual*

High-Performance/Low-Noise General-Purpose AC Motor Drives



230V / 3-Phase
0.75 ~ 22KW
1 ~ 30HP

460V / 3-Phase
0.75 ~ 22KW
1 ~ 30HP



ASIA

DELTA ELECTRONICS, INC.

Taoyuan Plant

31-1, SHIEN PAN ROAD, KUEI SAN INDUSTRIAL
ZONE TAOYUAN SHIEN, TAIWAN

TEL: 886-3-362-6301

FAX: 886-3-362-7267

www.deltaww.com/acdrives

EUROPE

DELTRONICS (NETHERLANDS) B.V.

INDUSTRIEGEBIED VENLO NR. 9031

COLUMBUSWEG 20

NL-5928 LC VENLO

THE NETHERLANDS

TEL: +31-77-324-1930

FAX: +31-77-324-1931

NORTH/SOUTH AMERICA

DELTA PRODUCTS CORPORATION

Sales Office

P.O. BOX 12173

5101 DAVIS DRIVE

RESEARCH TRIANGLE PARK,

NC 27709, U.S.A.

TEL: 1-919-767-3813

FAX: 1-919-767-3969

www.deltaww.com/acdrives

5011200503

200305-22



AE02



VFD-A/H

User Manual

High-Performance/Low-Noise General-Purpose AC Motor Drives

TABLE OF CONTENTS

Chapter 1	Introduction		
	Getting Started	1	
	Receiving Storage and Transportation	2	
	Nameplate Information	2	
	Identification of components and accessories	3	
Chapter 2	Installation and Wiring		
	Installation Requirements	5	
	Main Circuit Wiring	6	
	Control Circuit Wiring.....	9	
	Basic Wiring Diagram	10	
Chapter 3	Digital Keypad Operation		
	Description of the Digital Keypad.....	11	
	Explanation of Displayed Messages	12	
Chapter 4	Start Up	16	
Chapter 5	Parameter Settings	19	
Chapter 6	Summary of Parameter Settings	52	
Chapter 7	Troubleshooting and Fault information	57	
Appendix A	Standard Specifications	61	
Appendix B	Serial Communications	64	
Appendix C	Dimensions	70	
Appendix D	Accessories List	77	
Appendix E	EMI Filters	78	
Appendix F	EC Declaration of Conformity	79	
Appendix G	NFB (No-Fuse Breaker) Specification	81	

Introduction

Congratulations on your purchase of the DELTA VFD-A series AC motor drive. The VFD series is a high-performance / low noise general-purpose AC motor drive, manufactured using high-quality components and incorporating the latest micro-processor technology available.

The purpose of this chapter is to provide specific, yet simple information to **unpack**, **install**, and **operate** the AC drive. This chapter contains information on the following:

- **Getting Started**
- **Receiving, Transportation, and Storage**
- **Nameplate Information**
- **Identification of Components and Accessories**

■ **Getting Started**

This manual will help in the installation, parameter setting, troubleshooting, and maintenance of the AC drive. To guarantee safe operation of the equipment, read the following safety guidelines before connecting the drive to the AC power line. Keep this manual in a place where it is available to all users for their reference.

 **Warning!** To avoid personal injury, do not remove the cover of the AC motor drive until all of the digital keypad “DISPLAY LED” lamps are off. The DC-link capacitor remains charged with a hazardous voltage even after input power is removed.

 **Warning!** Do not connect or disconnect wires and connectors while power is applied to the circuit. All connections should be performed by qualified personnel.

 **Attention:** Grounding the VFD-A drive is done by **connecting the Earth Ground to the drive ground terminal**.

 **Attention:** The final enclosure for operating the AC Motor Drive must comply with the requirements of EN 50178. (Live parts shall be arranged in enclosures or located behind barriers that meet at least the requirements of the **Protective Type IP20**; Top surfaces of enclosures or barriers that are easily accessible shall meet at least the requirements of the **Protective Type IP40**)

 **Caution:** There are highly sensitive components on the printed circuit boards. These components are especially sensitive to ESD (electrostatic discharge). **To avoid damage to the drive**, do not touch components or the circuit boards until all static control precautions have been taken.

 **Caution:** Never connect the main circuit output terminals U, V, and W directly to the AC main circuit power supply as **this will damage the drive**.

 **Caution:** Do not apply the antirust to screws for fastening drives; Please clean the drives and screws with dry cloth or alcohol, not with synthetic cleaner. Fasten the screws with washers and rated torque lest the enclosure corners of drives be distorted.

This manual is for DELTA AC Motor Drive VFD-A and VFD-H Series. For the frequency in Pr.03, Pr.04, Pr.06, Pr.16, Pr.17, Pr.18, Pr.19, Pr.20, Pr.21, Pr.22, Pr.23, Pr.36, Pr.37, Pr.47, Pr.67, Pr.68 and Pr.69, VFD-A Series can be regulated up to 400Hz and VFD-H Series up to 1500Hz.

■ **Receiving, Storage and Transportation**

The AC motor drive has gone through rigorous quality control tests at the factory before shipment. After receiving the AC drive, check for the following.

Receiving

- ✓ Check to make sure that the package includes an AC drive, the User Manual, dust covers and rubber bushings.
- ✓ Inspect the unit to insure it was not damaged during shipment.
- ✓ Make sure that the part number indicated on the nameplate corresponds with the part number of your order.

Storage

The AC Drive should be kept in the shipping carton before installation. In order to retain the warranty coverage, the AC drive should be stored properly when it is not to be used for an extended period of time. Some storage suggestions are:

- ✓ Store in a clean, dry location.
- ✓ Store within an ambient temperature range of -20°C to +60°C.
- ✓ If possible, store in an air-conditioned environment where the relative humidity is less than 95%, non-condensing.
- ✓ Do not store the AC drive in places where it could be exposed to corrosive gases.
- ✓ Do not store the AC drive on a shelf or on an unstable surface.

Transportation

Temperature: -25°C to +70°C; R.H.: 0% to 95%; Air Pressure: 70kPa to 106kPa.

■ **Nameplate Information**

3HP, 440V AC Drive example

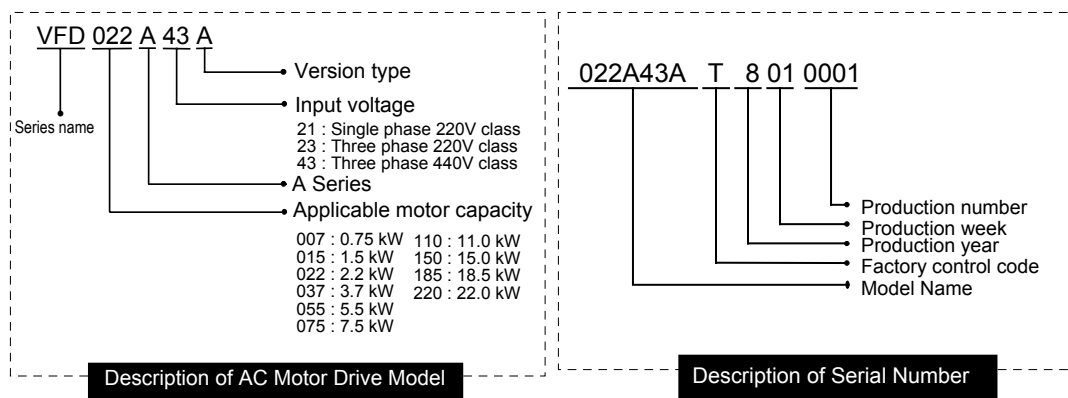
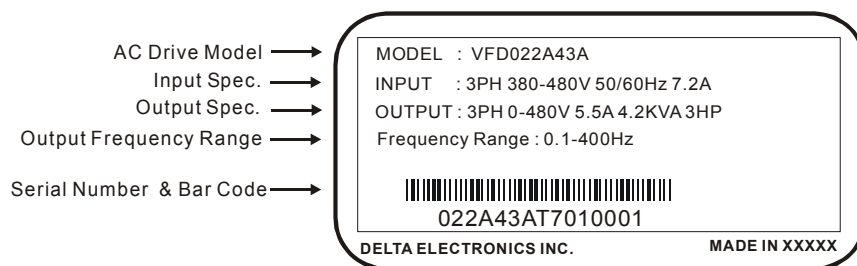

■ Identification of components and accessories



1. Mounting screw holes
2. Heat sink
3. Digital keypad
4. Ventilation hole and blind plate installation position
5. Nameplate label
6. Terminal cover
7. Input / output rating
8. Cooling fan
9. External braking resistor (optional)

Removing and Installing the Front Cover

Refer to the figure shown below to remove the front cover. To re-install the front cover, simply reverse the indicated procedures.

◆0.75 - 1.5 KW (1-2HP)
The front cover snaps on. Pull as shown to remove the front cover.



◆2.2 - 3.7 KW (3-5HP)
The front terminal block cover snaps on. Pull as shown to release cover.



◆5.5 - 22.0 KW (7.5-30HP)

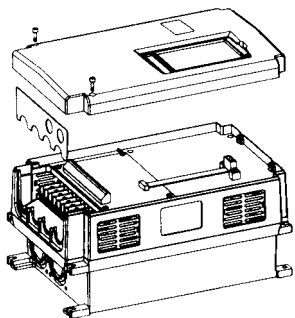

◆5.5 - 22.0 KW (7.5-30HP)

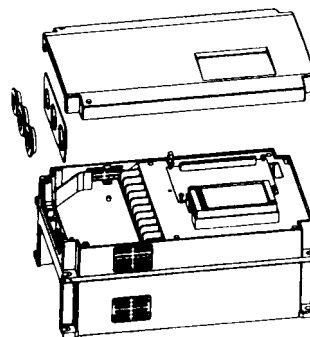

Removing the Digital Keypad

The digital keypad can be easily removed from the AC motor drive unit as shown below.

◆ 0.75 - 1.5 KW (1-2HP)

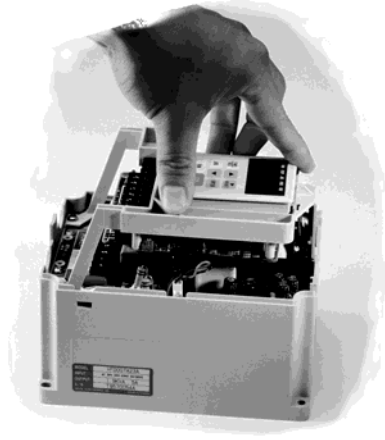

◆ 2.2 - 3.7 KW (3-5HP)



◆ 5.5 KW - 22.0 KW The 7.5 thru 30 HP units have screws holding the digital keypads in place. To remove the keypad, first remove the screws and then lift the keypad out of the AC drive.

◆ 5.5 – 7.5 KW (7.5-10HP)

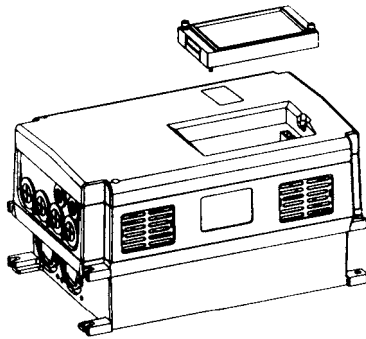

◆ 11.0 – 22.0 KW (15-30HP)

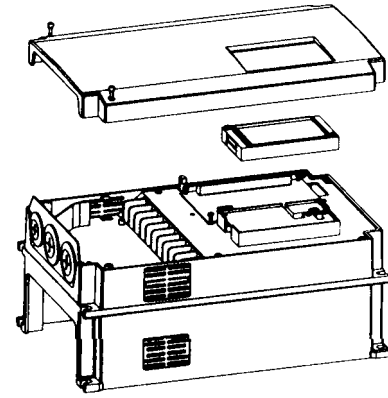

◆ Installing the Optional Remote Control Unit (RC-01)



Installation and Wiring

Chapter 2 provides the information needed to properly **install** and **wire** the AC drive. Make sure that the AC drive is wired according to the instructions contained in this chapter. The instructions should be read and understood before the actual installation begins.

- Installation Requirements
- Wiring
- Basic Wiring Diagram

■ Installation Requirements

Install the AC drive vertically to provide proper ventilation. Adequate space is required between the drive and a wall or other equipment. The figure below shows the minimum space needed. *All enclosures must provide adequate ventilation and the internal ambient temperature must be kept at 40°C or below.*

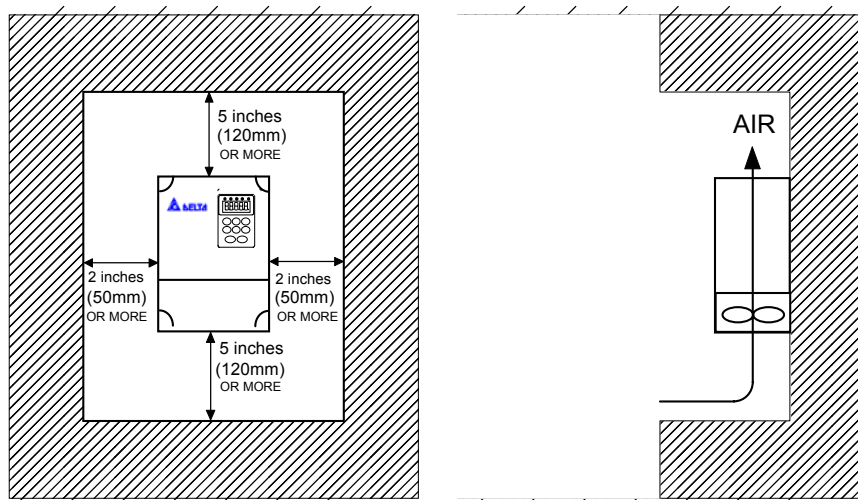

⚠ Caution: The AC drive should be installed in an environment that is:

- ✓ protected from rain or moisture;
 - ✓ protected from direct sunlight;
 - ✓ protected from corrosive gases or liquids;
 - ✓ free from airborne dust or metallic particles;
 - ✓ free from vibration;
 - ✓ free from magnetic noise
 - ✓ temperature: -10°C to +40°C; R.H.: 0% to 90%; air pressure: 86kPa to 106 kPa
- Violating the conditions listed above may void the warranty!**

■ Wiring

Main Circuit Wiring

(1) Power terminal block designations

Power input and output may be connected via a nine or ten position terminal block. The pin assignments are as follows:

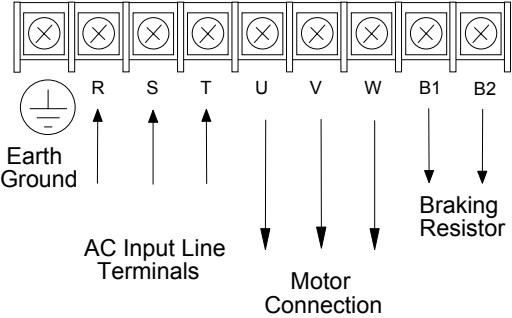
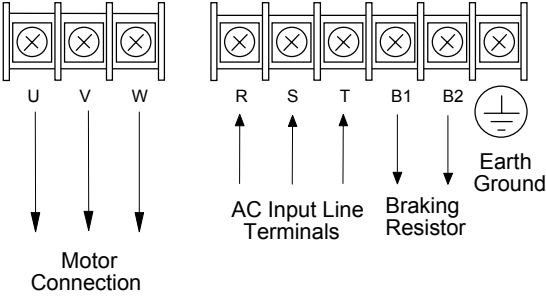
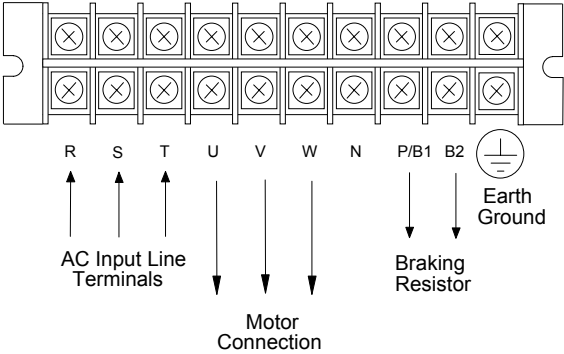
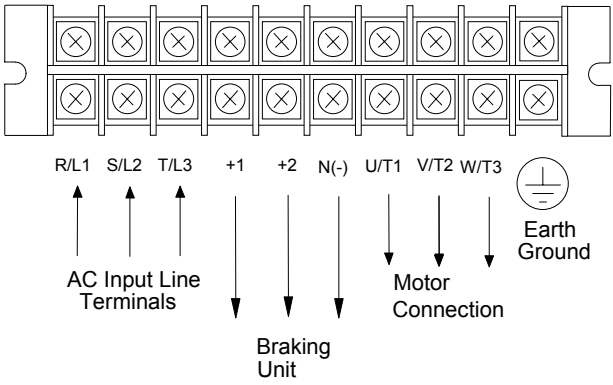
Model	Power terminal pin assignments
<p>VFD007A21A VFD007A23A VFD015A21A VFD015A23A VFD007A43A VFD015A43B</p> <p>AWG: 22-16 Torque: 10kgf-cm</p>	 <p>Earth Ground</p> <p>AC Input Line Terminals</p> <p>Motor Connection</p> <p>Braking Resistor</p>
<p>VFD022A21A VFD022A23A VFD037A23A VFD022A43A VFD037A43A</p> <p>AWG: 18-10 Torque: 16kgf-cm</p>	 <p>Motor Connection</p> <p>AC Input Line Terminals</p> <p>Braking Resistor</p> <p>Earth Ground</p>
<p>VFD055A23B VFD075A23B VFD055A43B VFD075A43B</p> <p>AWG: 14-8 Torque: 20kgf-cm</p>	 <p>AC Input Line Terminals</p> <p>Motor Connection</p> <p>Braking Resistor</p> <p>Earth Ground</p>
<p>VFD110A23A VFD150A23A VFD185A23A VFD220A23A VFD110A43A VFD150A43A VFD185A43A VFD220A43A</p> <p>AWG: 10-2 Torque: 52kgf-cm</p>	 <p>AC Input Line Terminals</p> <p>Braking Unit</p> <p>Motor Connection</p> <p>Earth Ground</p>

For VFD-A Series 15-30HP (VFD110A23A/43A, VFD150A23A/43A, VFD185A23A/43A, VFD220A23A/43A), the ring terminals below are suggested to be used when proceeding with main circuit wiring:

Vendor	AWG	Vendor Part NO.
Moles	2 (Red)	G-975-14
	4 (Yellow)	F-966-14
	6 (Blue)	E-957-14
	8 (Red)	D-950-14
AMP : ECBT	2	320383
	4	33469

(2) Power block terminal designations

Terminals	Description
R, S, T	AC input line terminals
U, V, W	Motor connection
P/B1, B2	Connection for the regenerative resistor (option)
P/B1, N	Connection for the braking unit
	Ground (connect appropriate ground wire to avoid electrical shock and noise interference)

(3) Terminal dimensions

Model	VFD007A21A-VFD007A23A		VFD022A21A-VFD022A23A		VFD055A23B-VFD075A23B	
	VFD015A21A-VFD015A23A		VFD037A23A		VFD055A43B-VFD075A43B	
	VFD007A43A-VFD015A43B		VFD022A43A-VFD037A43A			
Terminal	Terminal diameter	Terminal width	Terminal diameter	Terminal width	Terminal diameter	Terminal width
Spec.	M3	7 mm	M3.5	8 mm	M4	10 mm
Model	VFD110A23A-VFD110A43A					
	VFD150A23A-VFD150A43A					
	VFD185A23A-VFD185A43A					
	VFD220A23A-VFD220A43A					
Terminal	Terminal diameter	Terminal width				
Spec.	M6	18.5mm				

(4)  **Attention:**

- ✓ The user must provide a circuit breaker or disconnect switch and fuses in accordance with all applicable electrical codes.
- ✓ Make sure that the leads are connected correctly and the AC drive is properly grounded. (Ground leads should be at least the same size wire as the input leads R, S, and T.)
- ✓ Use ground leads that comply with AWG standards. Make the length of these ground leads as short as possible.
- ✓ Should several AC drive units be installed side by side, all the units should be grounded directly to the ground poles. Do not form a loop with the ground leads.



- ✓ Make sure that the power source supplies the correct voltage and is capable of supplying the required current to the AC drive. Refer to specification for “Rated AC Input Power.” Motor Voltage should match the line voltage.
- ✓ When power is applied to the AC drive, the DC bus charge indicator LED will be on.
- ✓ For single phase applications, the AC input line can be connected to any two of the three input terminals R, S, T. A single phase VFD-A drive can be powered from three phase as well as single phase.
Note: This drive is not intended for use with single-phase motors.
- ✓ When the AC drive output terminals U, V, and W are connected to the motor terminals U, V, and W, respectively, the motor will rotate counter-clockwise (viewed from the shaft of the motor as shown below) if a forward operation command is entered (FWD lamp is ON).

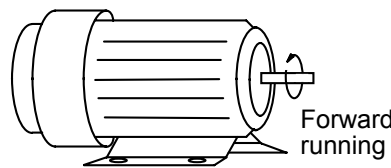

- ✓ To reverse the direction of rotation, interchange any two connections of the three motor leads.
- ✓ The control lines and power lines (R,S,T;U,V,W;P,N,B1,B2) should be separated and avoid parallel wiring lest it should generate noise and cause mis-operation.

 **Caution:** Do not attach or remove wiring or connectors when power is applied to the AC drive. Do not monitor the signals at any point on the circuit board while the AC drive is in operation.

 **Caution:** Do not connect the AC input to any of the U, V, W terminals, as this will damage the AC drive.

Control Circuit Wiring

(1) Control terminal block designations

The control leads must be routed separately from the power supply and motor leads. They must not be fed through the same cable conduit.

Terminal Symbol																					
220V/440V Class 1~5HP (AWG: 28 – 14; Torque:4 kgf-cm)																					
RA	RB	RC		+10V	AVI	ACI	AFM	ACM	MO1	MO2	MCM	+EV									
	MI1	MI2	MI3	FWD	REV	RST	EF	TRG	DCM	DFM	SG+	SG-	DCM								
220V/440V Class 7.5~30HP (AWG: 24 – 12; Torque:4 kgf-cm)																					
RA	RB	RC																			
	MI1	MI2	MI3	REV	FWD	RST	EF	TRG	DFM	DCM	MO1	MO2	MCM	+10V	AVI	ACI	AFM	XX	ACM	SG+	SG-

(2) Control terminal block descriptions

Close Contacts between Terminals	Terminals Use	Function
RA - RC	Multi-function indication output contact	Refer to Chapter 5, Pr.57
RB - RC	Multi-function indication output contact	
MI1 - DCM	Multi-function input 1	Refer to Chapter 5, Pr.39, 40, 41
MI2 - DCM	Multi-function input 2	
MI3 - DCM	Multi-function input 3	
REV - DCM	Reverse / Stop	“Open”→stop, “Close” → Reverse
FWD - DCM	Forward / Stop	“Open”→stop, “Close” → Forward
RST - DCM	Reset	“Close” → Reset
EF - DCM	External fault	“Close” → External fault
DFM - DCM	Digital frequency meter	Digital frequency output (0, +10 V)
TRG - DCM	Counter trigger input	“Open”→“Close”:(counter value)+1
MO1 - MCM	Multi-function PHC output 1	Refer to Pr.45, 46 (open collector output)
MO2 - MCM	Multi-function PHC output 2	
+10V - ACM	Power supply for speed setting	+10 V (20 mA max. output current)
AVI - ACM	Analog voltage input	0 ~10 V (Max. output freq.) input
ACI - ACM	Analog current input	4 ~20 mA (Max. output freq.) input
AFM - ACM	Analog frequency/current meter	0 ~10 V (Max. output freq.) output
SG+ - SG-	Serial communication interface	RS-485 serial port
+EV - DCM	Auxiliary control power source	DC 20V ~ 24V (50mA Max.)

Note: Use twisted-shielded or twisted-pair shielded-lead wires for the control signal. It is recommended to run signal wiring in a separate steel conduit. The shield wire should only be connected at the drive.

■ Basic Wiring Diagram

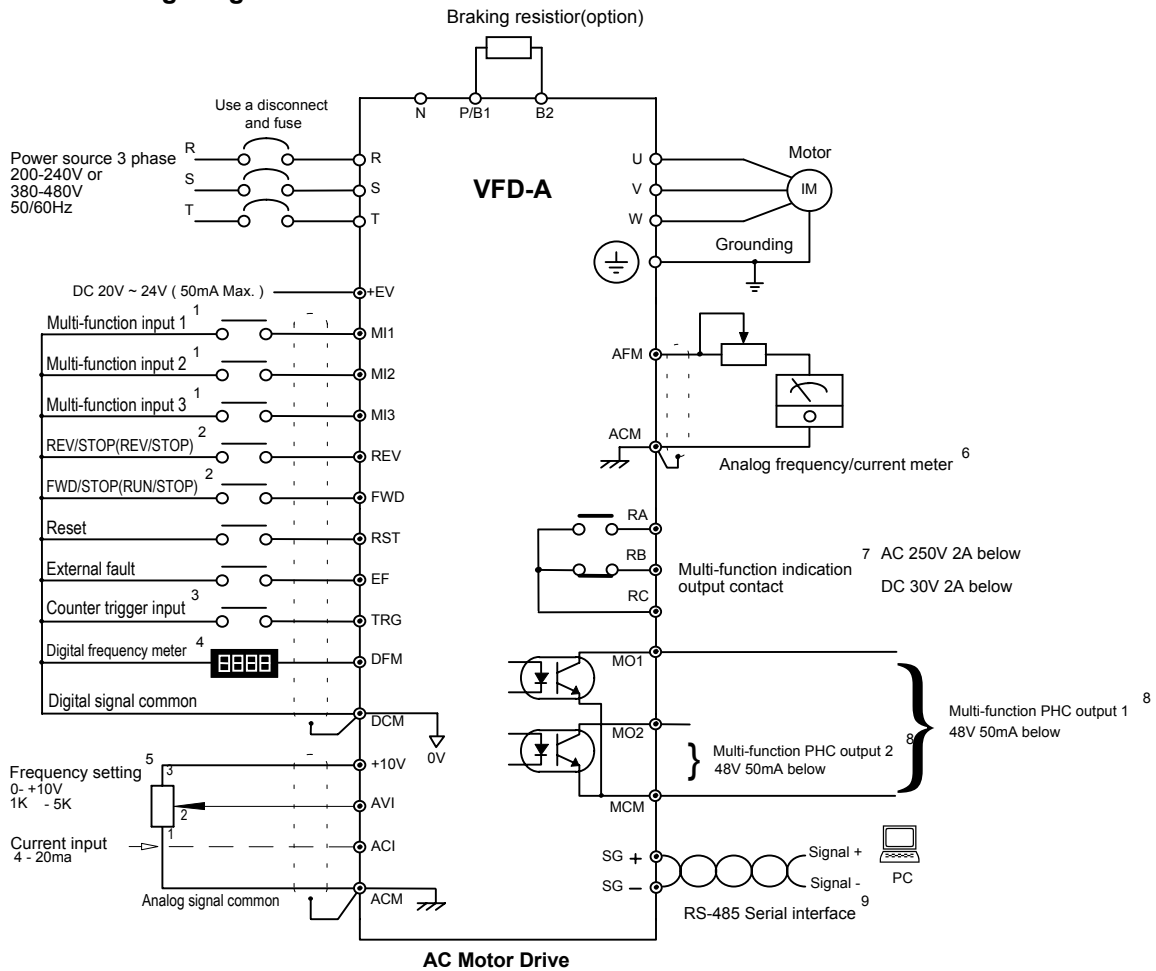

Notes A:

- 1 Refer to Pr.39, 40, 41 on page 35.
- 2 Refer to Pr.38 on page 34.
- 3 Refer to Pr.45, 46 on page 38 and Pr.63, 64, 66 on pages 45 and 46.
- 4 Refer to Pr.43 on page 36.
- 5 Refer to Pr.00 on page 21, Pr.48, 49 on page 39.
- 6 Refer to Pr.42, 44 on pages 36 and 37.
- 7 Refer to Pr.57 on page 42.
- 8 Refer to Pr.45, 46 on page 38.
- 9 Refer to Pr.00, 01 on page 21 and Pr.77, 78 on page 50.

Notes B:

1. indicates shielded leads and twisted-pair shielded leads.
2. Terminal symbols : ○ shows main circuit; ● shows control circuit;

■ Wiring diagram and programming for the RC-01 external control.

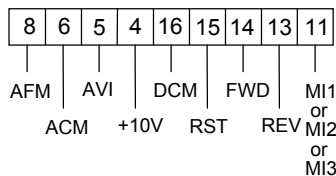

Program Parameters

Pr. 00 = d0001 Pr. 01 = d0001 or d0002
 Pr. 38 = d0001 Pr. 39, Pr. 40 or Pr. 41 = d0003
 Note: Pr. 41 > Pr. 40 > Pr. 39

Digital Keypad Operation

Chapter 3 describes the various controls and indicators found on the digital keypad of the VFD-A AC drive. The information in this chapter should be read and understood before performing the start-up procedures described in Chapter 4.

- Description of the Digital Keypad
- Explanation of Screen Display
- Digital Keypad Operating Modes & Programming steps

■ Description of the Digital Keypad

Digital Keypad Parts and Functions

This digital keypad module includes two parts: display panel and a keypad. The display panel allows the user to program the AC drive, as well as view the different operating parameters. The keypad is the user interface to the AC motor drive. Refer to the following figure for a description of the different parts.

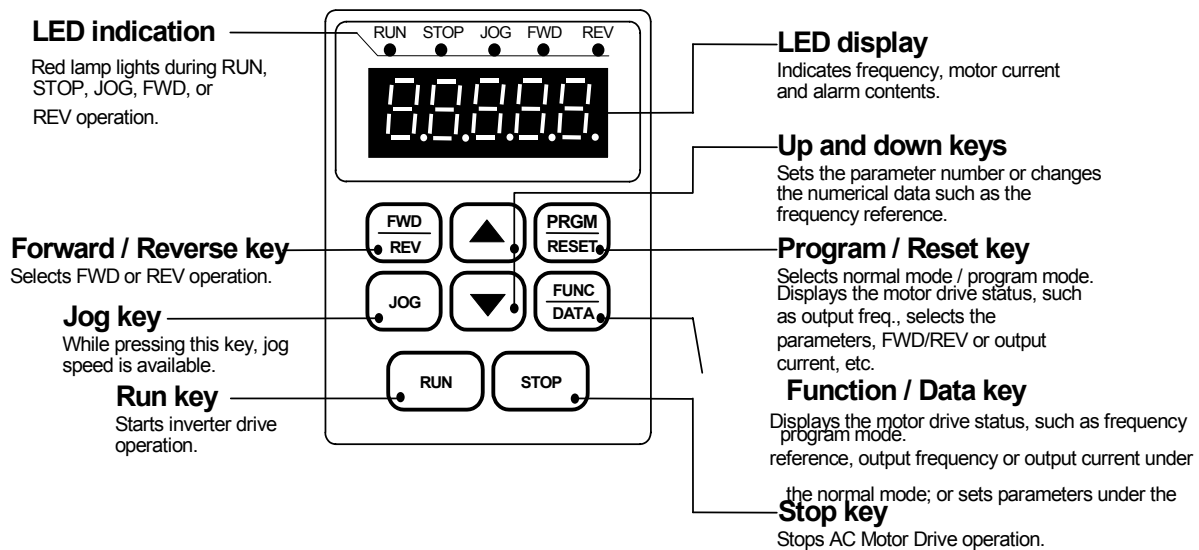

Program / Reset

Used to select the Normal mode of operation or to program the AC drive when either the drive is running or has stopped. Switch to the PRGM mode to select a parameter or change the setting of a parameter. If the AC drive has stopped due to a fault, press this button to reset the drive.



Function / Data

Displays information on the AC drive status such as the reference frequency, output frequency, or output current in the normal mode.

While the drive is in the Program Mode, press this key once to display the current parameters. After changing the parameters, press this key again to store the new parameters.



Forward / Reverse

Used to toggle between forward and reverse operation.

Pressing this key will cause the motor to ramp down to 0 Hz and then ramp up to the preset speed in the opposite direction. By default, the digital keypad controls the AC drive forward/reverse operation. To control the forward/reverse operation via the control terminal block, change the Pr.01 parameter to “d0001” or “d0002”.



Jog

Used to start the AC drive, then run at the jog frequency as set by the parameter specified under Pr.23 [Jog Frequency].



Run

Used to start the AC drive operation. This key has no effect when the drive is set to terminal run.



Stop

Used to stop the AC drive operation.



Up / Down









Press the “Up” or “Down” button to change parameter settings. These keys may also be used to scroll through different operating values or parameters.



Note: Pressing the “Up” or “Down” button momentarily changes the parameter settings in increments. Press and hold down either of these keys to rapidly run through the possible settings.

■ **Explanation of Displayed Messages**

Displayed Message	Description
	Displays the AC drive output frequency controlled by the Maximum Output Frequency (Pr. 03), Jog Frequency (Pr. 16), or by the Multi-Function Input Terminals (Pr. 39-41). If the frequency source originates from the Digital keypad, the user can use either the or key to set the frequency.
	Displays the output frequency present at terminals U, V, and W.
	Displays the custom unit (v), where v = H x Pr.65.
	Displays the internal counter value (C). Note: Refer to Chapter 5, Pr.45, 46, 64 - 66 for a detailed description of the above.

	Displays the output current present at terminals U, V, and W
	Displays the specified parameter number. The actual parameter value may be displayed by pressing the  key.
	Displays actual value stored within the specified parameter. Press the  key to store the value of the specified parameter.
	The display will read "end" (as shown) for approximately 1 second if the input has been accepted. After a parameter value has been set, the new value is automatically stored in memory. To modify an entry, use  or  key.

■ Explanation of the LED Indicators

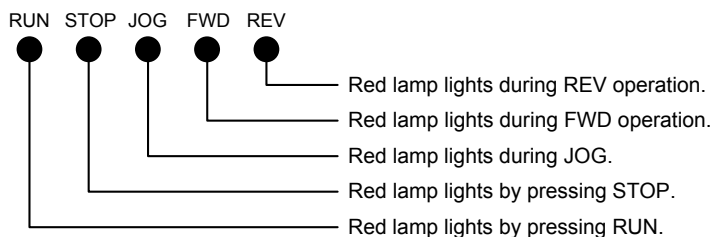

RUN or STOP lamp indication is defined by the following operation

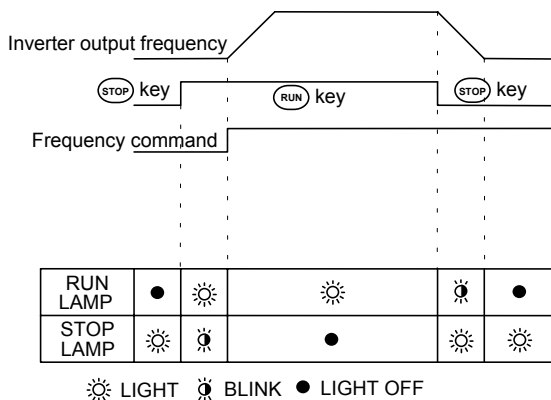

FWD or REV lamp changes indication is defined by the following operation

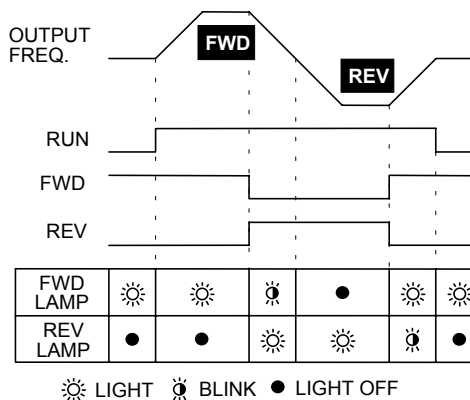

■ Digital Keypad Operating Modes & Programming steps

Pressing the **RUN** key after power on will cause the AC drive to operate at 60 Hz, which is the factory default setting. Use the **STOP** key to halt operation. Refer to the Basic Wiring Diagram in Chapter 2 for information on the wiring connection.

To change the operating frequency, proceed as follows:

The operating frequency may be changed in either the “STOP” or “RUN” mode.

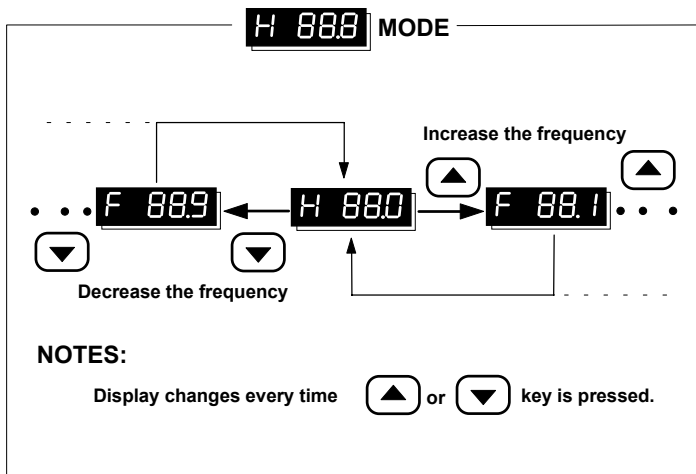
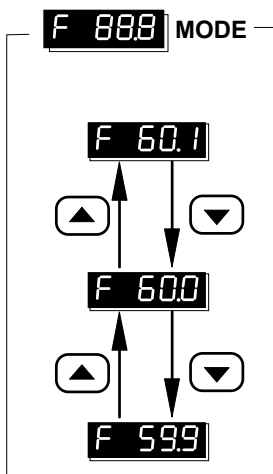

Setting parameters:

To operate the AC drive under optimum conditions, some parameter values may be modified as required. During the "Run" mode, the following set of parameters may be modified: 10-14, 16-23, 44, 48-50, 52-55, 65. It is also possible to check all the parameter settings during operation.

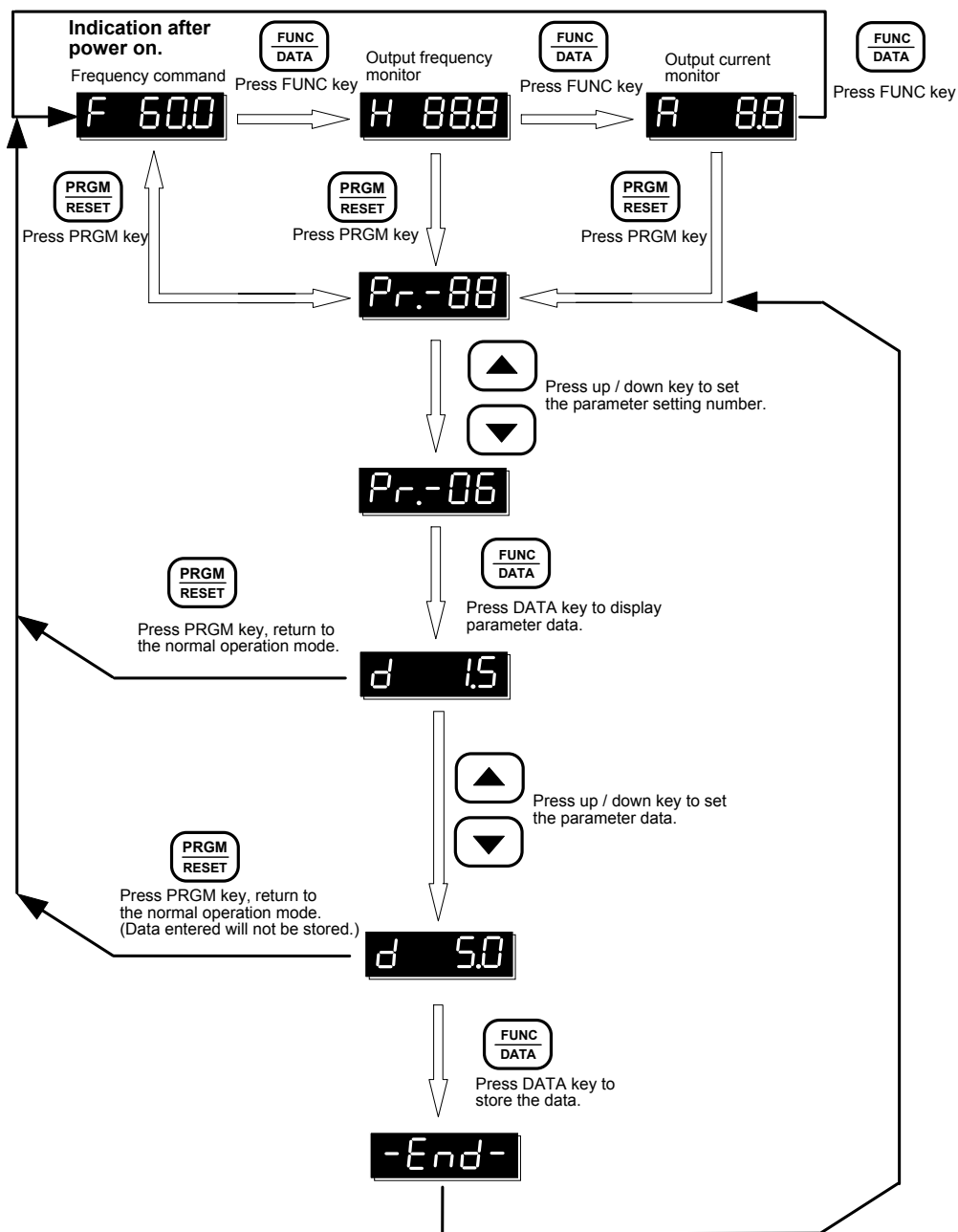

Start-up

This chapter describes the steps needed to start the AC drive and typical adjustment and verification procedures to ensure a simple and efficient start-up. The following start-up procedures describe the most common parameter settings and system configurations.

■ Initial Operation - Motor Disconnected

- ✓ **Verify that the AC power line, at the disconnect device, is within the rated power of the AC drive.**
- ✓ **Disconnect and lockout all incoming power to the drive.**
- ✓ **Connect the AC drive to the power line.**
- ✓ **Reconnect the incoming power to the drive.**
- ✓ **Proceed as follows to select a mode of operation.**
 1. Operating frequency determined by the digital keypad, Digital keypad enabled to control AC drive operation.
(Pr.00 = d0000, Pr.01 = d0000) (Factory default setting)

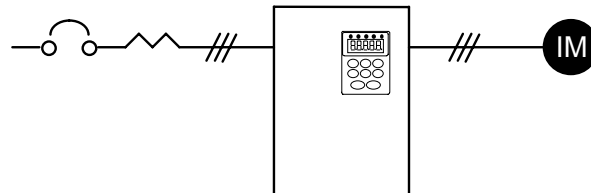

2. Operating frequency determined by the digital keypad, Control terminals enabled to control AC drive operation; "Stop" key on digital keypad is enabled.
Two wire "REV/STOP" and "FWD/STOP" remote control enabled.
(Pr.00 = d0000, Pr.01 = d0001, Pr.38 = d0000)

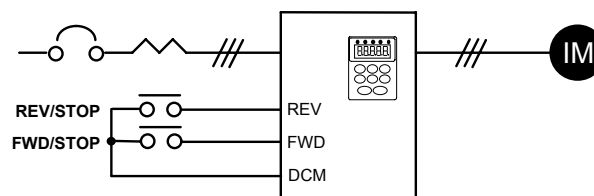

3. Operating frequency determined by the digital keypad;
Control terminals enabled to control AC Drive operation; "Stop" key on digital keypad is enabled.
Two wire "REV/FWD and "RUN/STOP" remote control enabled.
(Pr.00 = d0000, Pr.01 = d0001, Pr.38 = d0001)

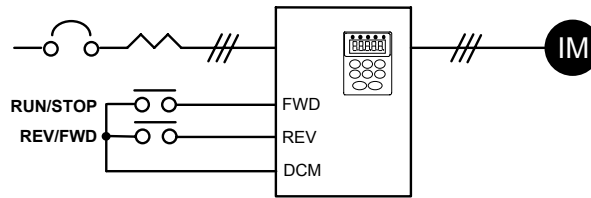

4. Operating frequency determined by the digital keypad;
Control terminals enabled to control AC Drive operation; "Stop" key on digital keypad is enabled.
Three wire sequence remote control is enabled.
(Pr.00 = d0000, Pr.01 = d0001, Pr.38 = d0002)

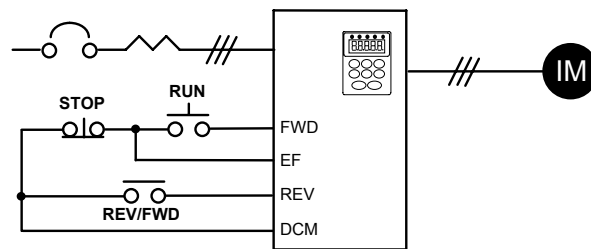

Note: Descriptions of the close / open function are as follows:
Example: To select Rev and Stop operations:
Rev / Fwd Contact "close" = reverse operation
Stop Contact "open" = stop

$\frac{O}{O}$	$\frac{1}{O}$	Momentary input
$\frac{O}{O}$		Maintained input

5. Operating frequency determined by analog input;
(DC 0 to +10 V) + (DC 4 to 20 mA)
Digital keypad enabled to control AC Drive operation.
(Pr.00 = d0001, Pr.01 = d0000)

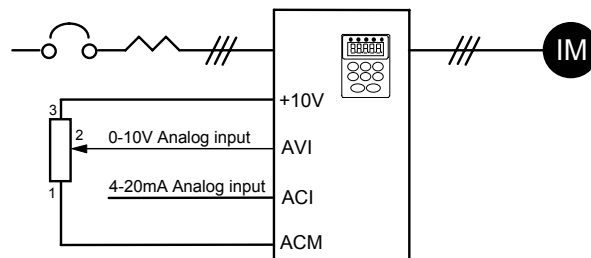

6. Operating frequency determined by remote control via the RS-485 serial interface; RS-485 interface enabled to control AC Drive operation. "Stop" key on digital keypad is enabled.
(Pr.00 = d0002, Pr.01 = d0003)

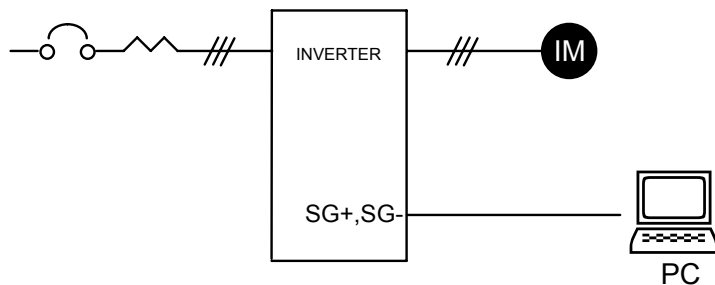

This completes the operation mode selection. Verify your operation mode works correctly, then proceed to the next section for motor connection and initial operation.

■ Initial Operation – Setting Parameters and connecting the Motor.

- 1) Verify Minimum and Maximum Output Frequency Settings (Pr. 08 and 03) are correct for your application.
- 2) Verify the Motor Stop Method (Pr.02) is correct for your application. If set to "Ramp to Stop", then verify the Accel/Decel Time Settings (Pr.10 and 11) are correct for your application.
- 3) Disconnect and lock out all incoming power to the AC drive. A DC bus voltage may be present at the terminal block for up to 1 minute after the power has been removed from the drive.
- 4) Connect the motor to the terminals U, V, and W
- 5) Connect all applicable control wiring. Refer to the Control Circuit Wiring diagram in Chapter 2.
- 6) Reconnect the incoming power to the AC drive.
- 7) Check for correct motor shaft rotation (counter clockwise when viewed from the shaft).
- 8) Verify the Stop command is functioning by pressing the Stop Key on the Digital Keypad or using your Control Terminal Stop method.

This completes the basic start-up. Depending on the application, some parameter values may need to be modified. Refer to Chapter 5 for parameter settings.

Parameter Settings

Chapter 5 describes all VFD-A drive parameters. These parameters are divided into groups to simplify “start-up” programming procedures and minimize tuning.

AC Drive parameters and functions:

Operation Modes	21
V / F Data Settings	22
Accel. / Decel. Time Setting	25
Frequency Reference Setting	27
Operating and Protective Functions Setting	28
External Control Terminal	34
Torque and Slip Compensation	41
Overload Detection	43
Display Functions	46
System Functions	47

- ◇ **Ramp** The AC drive output frequency decelerates in the time specified by Pr.11 or Pr.13, down to the frequency specified by Pr.08, and then the drive output turns off.
- ◇ **Coast** The AC drive is turned off immediately while the motor free runs until it comes to a complete stop.

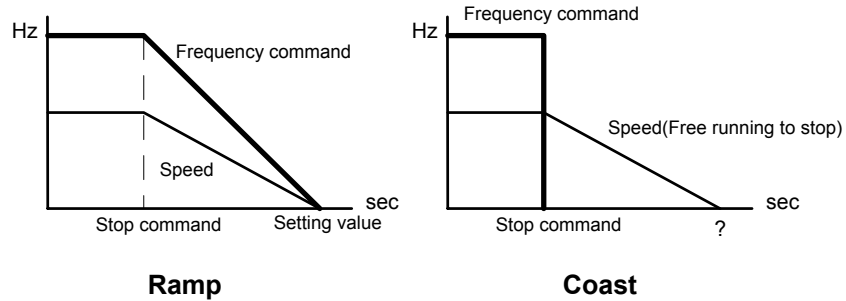

V / F Data Setting

Pr.03 Pr.04 Pr.05 Pr.06 Pr.07 Pr.08 Pr.09 V / F Curve

Parameter # 03

Parameter Name Maximum output frequency

Factory Setting d060.0 Hz

Units 0.1 Hz

Parameter value d050.0 - d400.0 Hz

📖 This parameter determines the AC drive's maximum output frequency. All the AC drive analog inputs (0 - 10V, 4 - 20mA) are scaled to correspond to the output frequency range. (See graph on Page 24)

Parameter # 04

Parameter Name Maximum voltage frequency (Base frequency)

Factory Setting d060.0 Hz

Units 0.1 Hz

Parameter value d010.0 -d400.0 Hz

📖 This value should be set according to rated frequency of the motor as indicated on the motor nameplate (See graph on Page 24). Maximum voltage frequency determines the volts per hertz ratio. For example, if the drive is rated for 460 VAC output and the maximum voltage frequency is set to 60Hz, the drive will maintain a constant ratio of 7.66 v/Hz.

Parameter # 05

Parameter Name Maximum output voltage

Factory Setting d220.0 V ; d440.0 for 440 V class.

Units 0.1 V

Parameter value d002.0 - d255.0 V ; d004.0 – d510.0 for 440 V class.

 This parameter determines the Maximum Output Voltage of the AC drive. The maximum output voltage setting must be smaller than or equal to the rated voltage of the motor as indicated on the motor nameplate. (See graph on Page 24)

Parameter # 06

Parameter Name Mid-point frequency

Factory Setting d001.5 Hz

Units 0.1 Hz

Parameter value d000.1 - d400.0 Hz

 This parameter sets the Mid-point frequency on the V/F curve. It may be used to determine the V/F ratio between the Minimum frequency and the Mid-point frequency. (See graph on Page 24)

Parameter # 07

Parameter Name Mid-point voltage

Factory Setting d010.0 V ; d020.0 for 440 V class.

Units 0.1 V

Parameter value d002.0 - d255.0 V ; d004.0 – d510.0 for 440 V class.

 This parameter sets the Mid-point voltage on the V/F curve. It may be used to determine the V/F ratio between the Minimum frequency and the Mid-point frequency. (See graph on Page 24)

Parameter # 08

Parameter Name Minimum output frequency

Factory Setting d001.5 Hz

Units 0.1 Hz

Parameter value d000.1 - d020.0 Hz

 This parameter sets the minimum output frequency of the AC Drive. (See graph on Page 24)

Parameter # 09

Parameter Name Minimum output voltage

Factory Setting d010.0 V ; d020.0 for 440 V class.

Units 0.1 V

Parameter value d002.0 - d050.0 V ; d004.0 – d100.0 for 440 V class.

 This parameter sets the minimum output voltage of the AC Drive.

Voltage

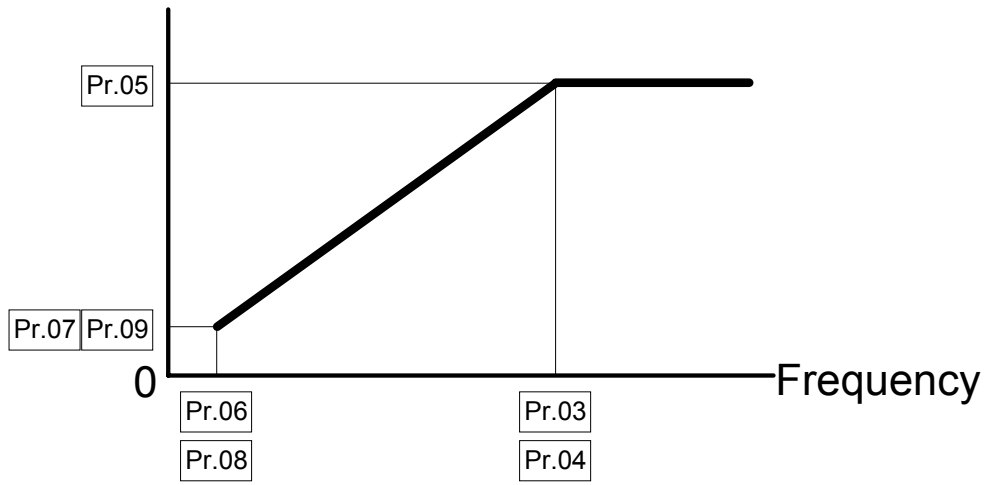

Standard V/F Curve

Voltage

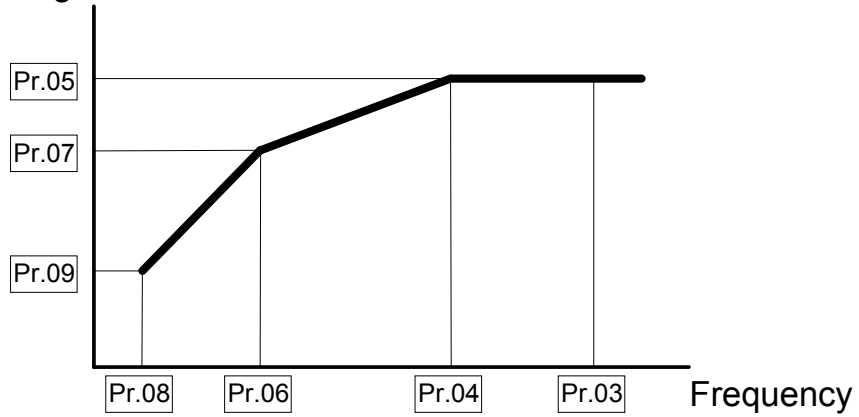

Custom V/F Curve

Voltage

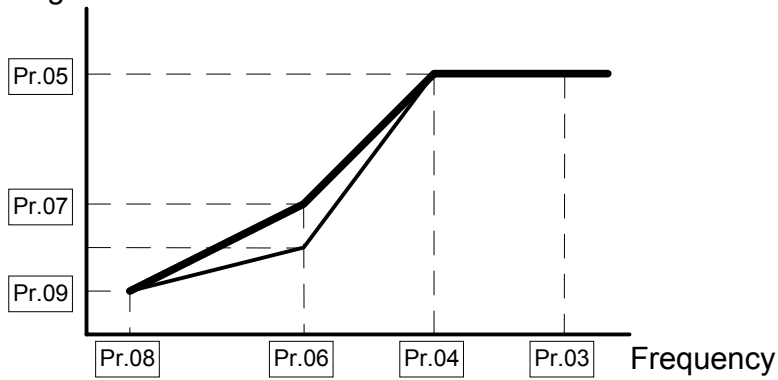

Fan/Pump V/F Curve

(1) General Purpose

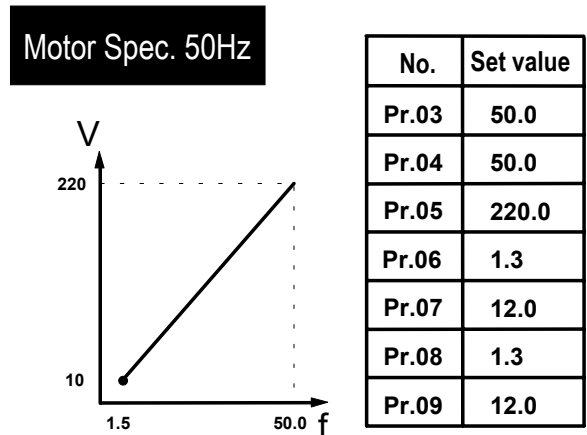
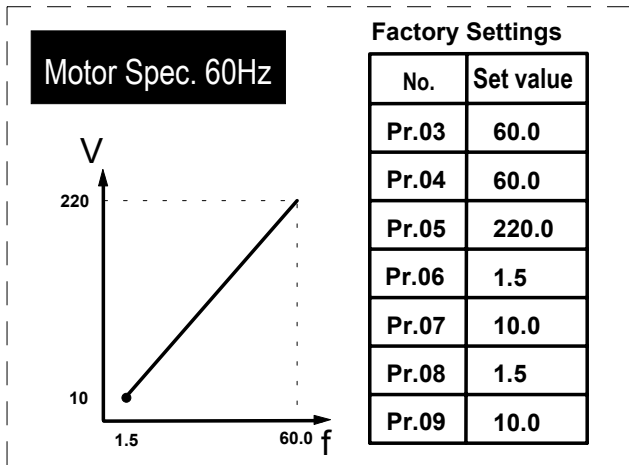

(2) Fans and Pumps

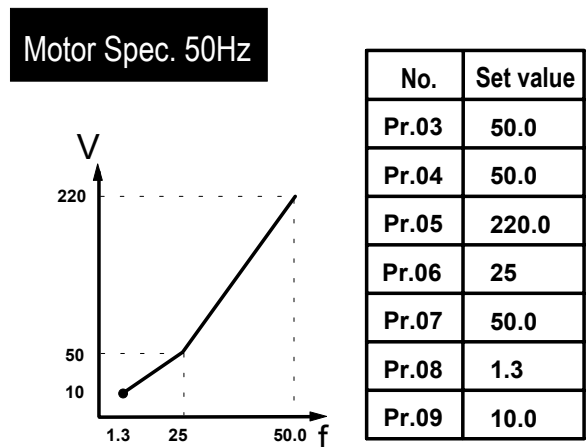
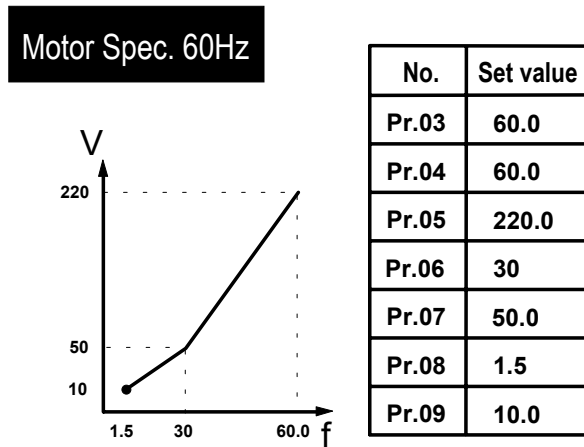

(3) High Starting Torque

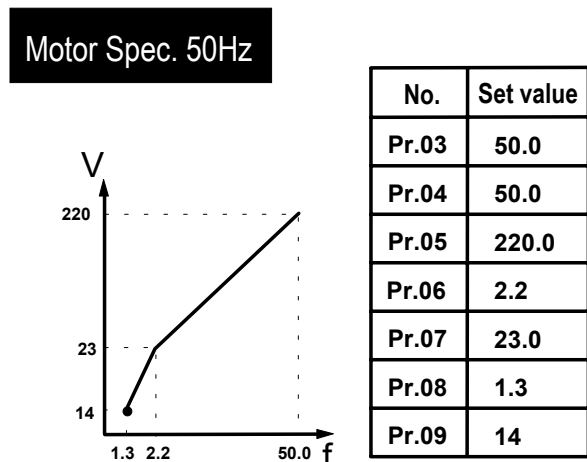
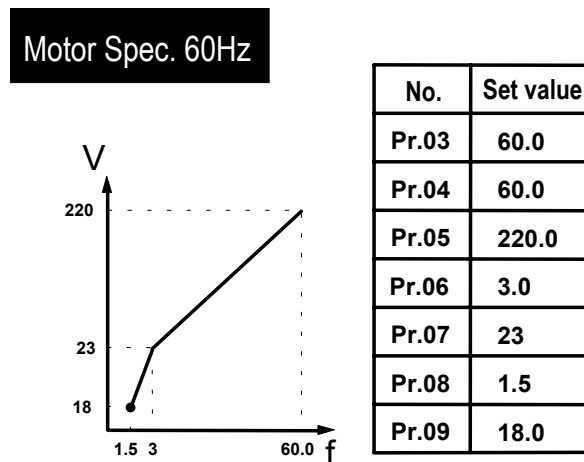

Pr.10 **Pr.11** **Pr.12** **Pr.13** Accel / Decel Time Setting

Parameter # 10

Parameter Name Acceleration Time 1

Factory Setting d010.0 Sec

Units 0.1 Sec

Parameter value d000.1 - d600.0 Sec

 This parameter can be programmed while the drive is running.

 This parameter is used to determine the time required for the AC drive to ramp from 0 Hz to its Maximum operating frequency (Pr.03). The rate is linear unless S Curve is "Enabled."

Parameter # 11

Parameter Name Deceleration Time 1

Factory Setting d010.0 Sec

Units 0.1 Sec

Parameter value d000.1 - d600.0 Sec

 This parameter can be programmed while the drive is running.

 This parameter is used to determine the time required for the AC drive to decelerate from the Maximum operating frequency (Pr.03) down to 0 Hz. The rate is linear unless S Curve is "Enabled."

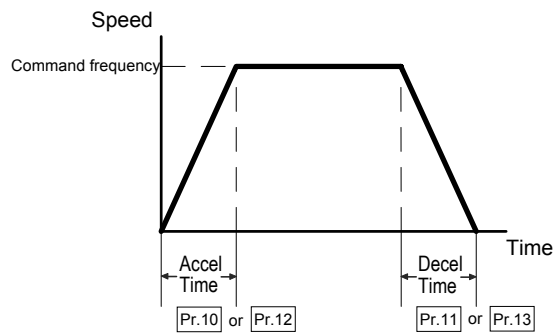

Parameter # 12

Parameter Name Acceleration time 2

Factory Setting d010.0 Sec

Units 0.1 Sec

Parameter value d000.1 - d600.0 Sec

 This parameter can be programmed while the drive is running.

 This parameter determines the time required for the AC drive to ramp from 0 Hz to the Maximum operating frequency (Pr.03). The rate is linear unless S Curve is "Enabled." Acceleration time 1 is the default. A Multi-Function Input Terminal can be programmed to select Acceleration time 1 or Acceleration time 2. See parameters 39, 40, and 41.

Parameter # 13

Parameter Name Deceleration time 2

Factory Setting d010.0 Sec

Units 0.1 Sec

Parameter value d000.1 - d600.0 Sec

 This parameter can be programmed while the drive is running.

 This parameter determines the time for the AC drive to decelerate from the Maximum operating frequency (Pr.03) down to 0 Hz. The rate is linear unless S Curve is "Enabled." Deceleration time 1 is the default. A Multi-Function Input Terminal can be programmed to select Deceleration time 1 or Deceleration time 2. See parameters 39, 40, and 41.

Pr.14 Jog Accel / Decel Time

Parameter # 14

Parameter Name Jog Accel / Decel time select

Factory Setting d010.0 Sec

Units 0.1 Sec

Parameter value d000.1 - d600.0 Sec

 This parameter can be programmed while the drive is running.

 This parameter determines the time required for the AC Drive to ramp from 0 Hz to the Jog frequency and the time required to ramp from the Jog frequency to 0 Hz.

 This parameter must accompany with parameter P111 deceleration S curve. In order to get the different results of S curves, just setting the parameter P111 to meet the requirement.

Pr.15 S-curve

Parameter # 15

Parameter Name S-curve setting
Factory Setting d0000 (Disabled)
Parameter value d0000 - d0007

This parameter should be set during start-up. It is used to provide smooth acceleration and deceleration. The S-curve may be set from 1 to 7.

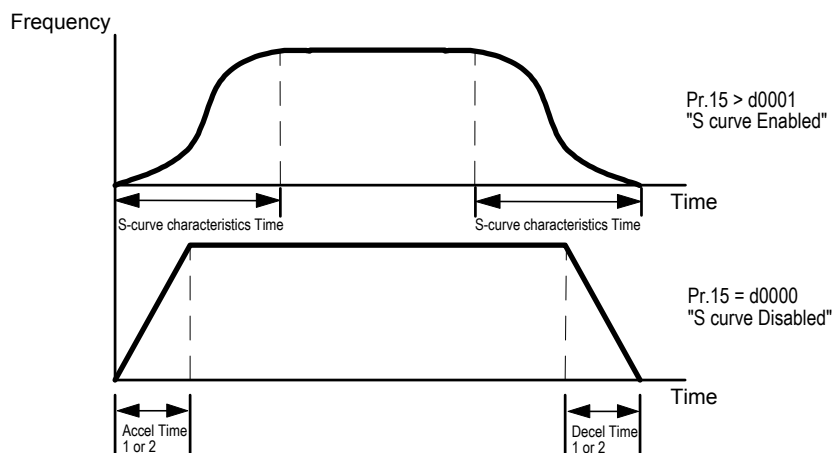

Frequency Reference Setting

Pr.16 Pr.17 Pr.18 Pr.19 Pr.20 Pr.21 Pr.22 Multi-speed Operation

Parameter # 16, 17, 18, 19, 20, 21, 22

Parameter Name Multi-step speed setting 1, 2, 3, 4, 5, 6, 7
Factory Setting d000.0 Hz
Units 0.1 Hz
Parameter value d000.1 - d400.0 Hz

These parameters can be programmed while the drive is running.

The multi-function input terminals (refer to parameters 39, 40, and 41) are used to select one of eight AC drive Multi-Speed output frequencies. The frequency is determined by Pr.16 to 22.

Pr.23 Jog Frequency

Parameter # 23

Parameter Name Jog frequency select

Factory Setting d006.0 Hz

Units 0.1 Hz

Parameter value d000.1 - d400.0 Hz

 This parameter can be programmed while the drive is running.

 This parameter is used to set the AC drive jog frequency. Upon receipt of a jog command the drive will ramp to the jog frequency.

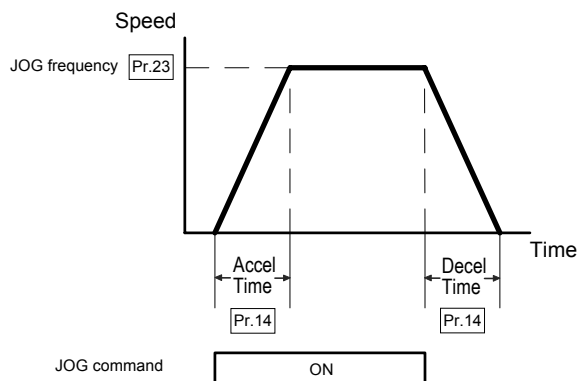

Operating and Protective Functions Setting

Pr.24 REV Run Setting

Parameter # 24

Parameter Name REV run

Factory Setting d0000

Settings d0000 REV run enabled

d0001 REV run disabled

 This parameter determines whether the AC Drive can operate in the reverse direction.

Pr.25 Over-voltage Stall Prevention

Parameter # 25

Parameter Name Over-voltage stall prevention during deceleration

Factory Setting d0001

Settings d0000 Disable over-voltage stall prevention
 d0001 Enable over-voltage stall prevention

 During deceleration, the motor DC bus voltage may exceed its maximum allowable value due to motor regeneration. When Pr.25 is enabled and an over-voltage is detected, the AC drive will cease to decelerate and will then maintain a constant output frequency. The drive will only resume deceleration when the DC bus voltage drops below the preset value.

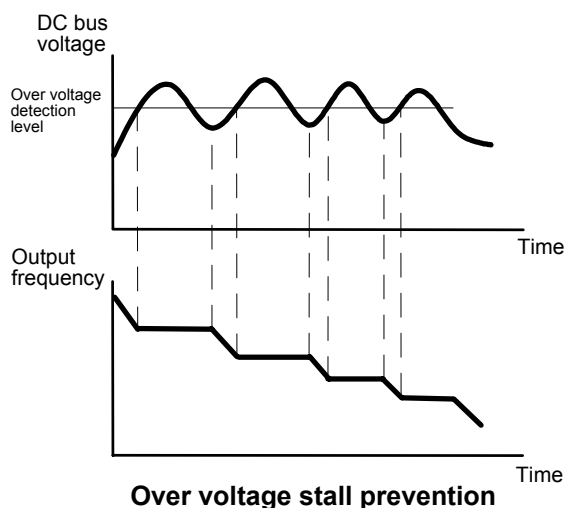

Pr.26 Pr.27 Over-current Stall Prevention

Parameter # 26

Parameter Name Over-current stall prevention during acceleration

Factory Setting d0170 %

Units 1%

Parameter value d0050 - d0200 %

 During periods of rapid acceleration or excessive load on the motor, the AC drive output current may increase abruptly and exceed the value specified by Pr.26. When over-current occurs, the AC drive will cease to accelerate and will maintain a constant output frequency until the current falls below the preset value. (The drive will only resume acceleration when the current drops below the preset value.)

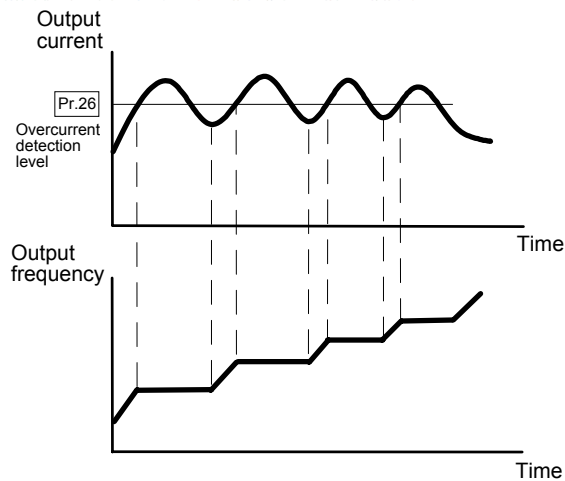

Stall prevention during acceleration

Parameter # 27

Parameter Name Over-current stall prevention during steady-state operation

Factory Setting d0170%

Units 1%

Parameter value d0050 - d0200%

 During steady-state operation with the motor load rapidly increasing, the AC drive output current may exceed the limit specified in Pr.27. When this occurs, the output frequency will decrease to maintain a constant motor speed. The drive will accelerate to the steady-state operating frequency only when the output current drops below the level specified by Pr.27. A setting of 100% is equal to the rated current of the drive.

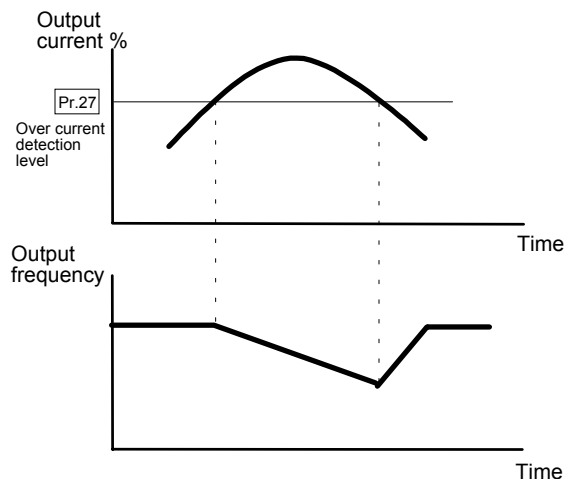

Over-current stall prevention during steady-state operation

Pr.28 Pr.29 Pr.30 Pr.31 DC Braking Current (DC Injection Current)

Parameter # 28

Parameter Name DC braking current
Factory Setting d0000%
Units 1%
Parameter value d0000 - d0100%

 This parameter determines the DC current that will be applied to the motor during braking when the Motor Stop Method is set to “RAMP stop” (refer to Pr.02). DC braking current is set in increments of 1%. A setting of 100% is equal to the rated current of drive.

Note: When setting this parameter, begin at a lower current level then increase the value until sufficient holding torque is achieved. The rated motor current cannot be exceeded.

Parameter # 29

Parameter Name DC braking time during start-up
Factory Setting d000.0 Sec
Units 0.1 Sec
Parameter value d000.0 - d005.0 Sec

 This parameter determines the time duration that DC braking current will be applied to the motor during the AC drive start-up.

Parameter # 30

Parameter Name DC braking time during stopping
Factory Setting d000.0 Sec
Units 0.1 Sec
Parameter value d000.0 - d025.0 Sec

 This parameter determines the time duration that DC braking current will be applied to the motor when the Motor Stop Method is set to “Ramp Stop”.

Parameter # 31

Parameter Name DC braking starting frequency
Factory Setting d000.0 Hz
Units 0.1 Hz
Parameter value d000.0 - d060.0 Hz

 This parameter determines the frequency at which DC braking will start during AC drive deceleration. The frequency may be set in 0.1 Hz increments. When the preset value is less than that specified by Pr.08 (Minimum output frequency), the starting frequency for DC braking will be the Pr.08 frequency.

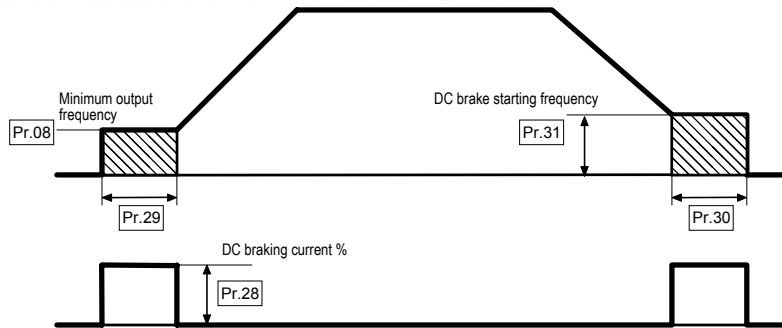

Pr.32 Pr.33 Pr.34 Pr.35 Momentary Power Loss Protection

Parameter # 32

Parameter Name Momentary power failure operation mode

Factory Setting d0000

- Settings**
- d0000 Operation stops after momentary power loss
 - d0001 Operation continues after momentary power loss. Speed search starts with the frequency reference value
 - d0002 Operation continues after momentary power loss. Speed search starts with the Minimum output frequency, Pr.08

Note Multi-function Indication and Photocoupler outputs that are programmed for “fault indication” will not be energized during restart after a momentary power failure. (refer to Pr. 45 and 57)

This parameter determines the AC drive mode of operation after recovery from a momentary power failure.

Parameter # 33

Parameter Name Maximum allowable power loss time

Factory Setting d002.0 Sec

Units 0.1 Sec

Parameter value d000.3 - d005.0 Sec

If during a power failure the power loss is less than the time defined by Pr.33, then the AC drive will resume operation (set by Pr.32). If the maximum allowable power loss time is exceeded, the AC drive output power will remain off and must be reset to resume operation (the fault indication will be set).

Parameter # 34

Parameter Name Minimum base block time

Factory Setting d000.5 Sec

Units 0.1 Sec

Parameter value d000.3 - d005.0 Sec

When a momentary power loss is detected and the power failure is less than the time set by Pr.33, the AC drive output will resume operation after the specified period of time determined by Pr.34. This parameter should be set to a value where the residual output voltage is nearly zero.

Parameter # 35
Parameter Name Speed Search Current Limit
Factory Setting d0150%
Units 1%
Parameter value d0030 - d0200%

Following a power failure, the AC drive will start its speed search operation, only if the output current is greater than the value determined by Pr.35. When the output current is less than that of Pr.35, the AC drive output frequency is at a “speed synchronization point”. The drive will start to accelerate or decelerate back to the operating frequency at which it was running prior to the power failure.

Speed search time increases as the current limit setting is reduced.

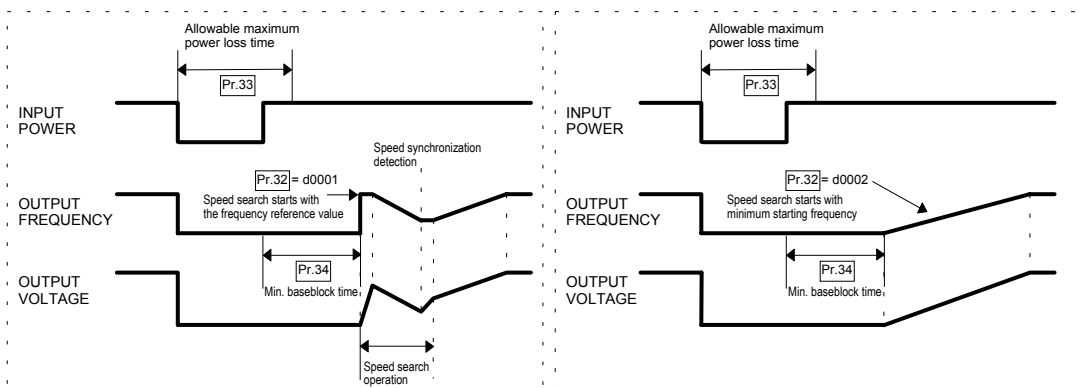

Pr.36 Pr.37 Reference Frequency Upper / Lower Limit

Parameter # 36
Parameter Name Reference frequency upper limit setting
Factory Setting d400.0 Hz
Units 0.1 Hz
Parameter value d000.1 - d400.0 Hz

Determines the upper limit of the reference frequency in 0.1 Hz increments.

Parameter # 37
Parameter Name Reference frequency lower limit setting
Factory Setting d000.0 Hz
Units 0.1 Hz
Parameter value d000.0 - d400.0 Hz

Determines the lower limit of the reference frequency in 0.1 Hz increments.

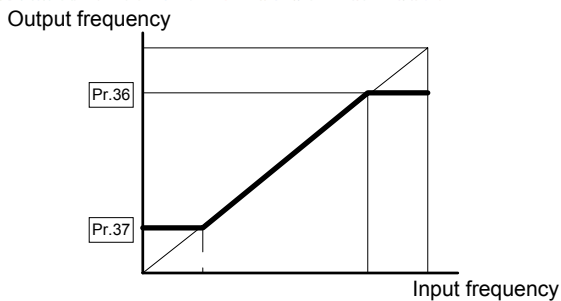

External Control Terminal

Pr.38 External Control Terminal Configuration

Parameter # 38

Parameter Name 2-wire / 3-wire operation control selection

Factory Setting d0000

Settings d0000 FWD / STOP, REV / STOP

d0001 FWD / REV, RUN / STOP

d0002 3-WIRE operation control mode

This parameter determines the control functions and operating modes available through the external control terminals. The following configurations are available:

Pr.38	Control terminal wiring diagram
d0000 Two wire FWD / STOP REV / STOP	<p>FWD "Open" : Stop; "Close" : FWD Run REV "Open" : Stop; "Close" : REV Run DCM</p> <p>VFD-A</p>
d0001 Two wire REV / FWD RUN / STOP	<p>FWD "Open" : Stop; "Close" : Run REV "Open" : FWD; "Close" : REV DCM</p> <p>VFD-A</p>
d0002 Three wire	<p>FWD (Run command, Runs when "Close") EF (Stop command, stops when "Open") REV (REV/FWD Run select "Open" : FWD Run "Close" : REV Run) DCM</p> <p>VFD-A</p>

Pr.39 Pr.40 Pr.41 Multi-function Input Terminals

Parameter #	39 (MI1), 40 (MI2), 41 (MI3)
Parameter Name	Multi-function input terminals 1, 2, 3
Factory Setting	d0000, d0001, d0002
Settings	d0000 Multi-step speed command 1 d0001 Multi-step speed command 2 d0002 Multi-step speed command 3 d0003 Jog frequency reference select d0004 Accel/decel speed inhibit command d0005 First and second accel/decel time select d0006 External baseblock (NO-contact input) d0007 External baseblock (NC-contact input) d0008 Up command d0009 Down command

Parameter setting value limit Pr.41> Pr.40> Pr.39.

Description

① d0000~d0002: The multi-step speed commands 1 to 3 are used to determine a command frequency via the multi-step speed settings (Pr.16 to Pr.22).

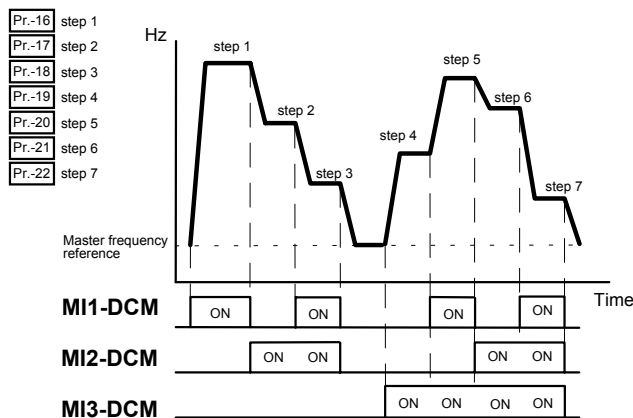

- ① d0003: When “Closed,” the jog reference frequency is selected.
- ② d0004: When “Closed,” the output frequency remains constant.
- ③ d0005: When “Open,” the AC drive accelerates / decelerates according to the values set by ACCEL time 1 and DECEL time 1 (Pr.10,11). When “Closed,” the AC drive accelerates / decelerates according to the values set by in ACCEL time 2 and DECEL time 2 (Pr.12, 13).
- ④ d0006: When “Closed,” the AC drive output is turned off. (The reference frequency is held constant.)
- ⑤ d0007: When “Open,” the AC Drive output is turned off. (The reference frequency is held constant)

⑥ d0008: When “Closed,” the AC Drive output frequency is increased.

⑦ d0009: When “Closed,” the AC Drive output frequency is decreased.

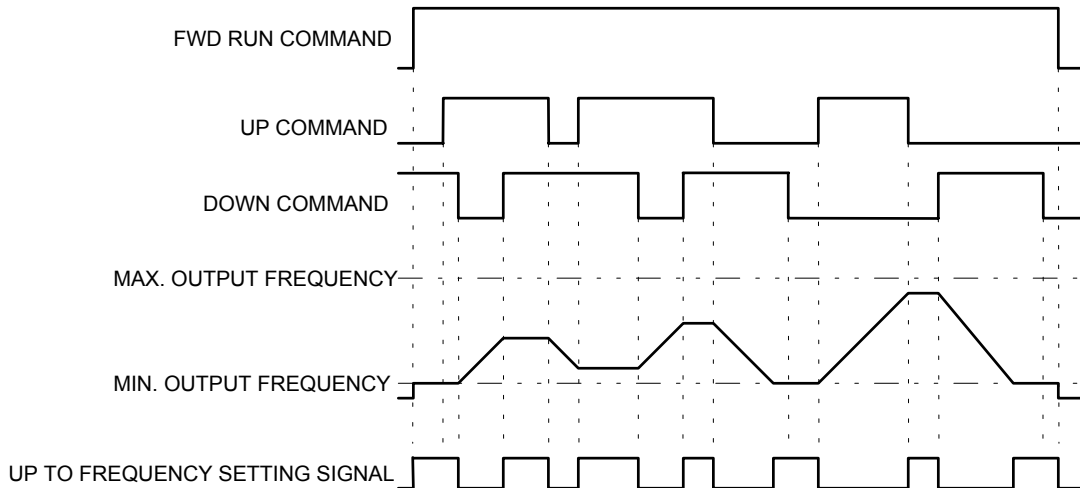

Note: When both the Up and Down command terminals are “closed”, the AC drive neither accelerates or decelerates. The output frequency is also held constant.

Pr.42 Analog Meter Output Select

Parameter # 42

Parameter Name Analog meter output select

Factory Setting d0000

Settings d0000 Analog frequency meter (0 to [Maximum Frequency])
 d0001 Analog current meter (0 to 250% of the rated drive output current)

This parameter selects the analog Meter output for either output frequency or output current (refer to Control Terminals AFM, ACM).

Pr.43 Digital Output Frequency Multiplier Factor

Parameter # 43

Parameter Name Digital output frequency multiplier factor

Factory Setting d0001

Units 1

Parameter value d0001 - d0020

This parameter determines the multiplying factor for the AC drive digital output frequency (+10V pulse, 50% duty cycle) at the digital output terminals (DFM, DCM). The number of output pulses per second on DFM is equal to the AC drive output frequency multiplied by Pr.43. The maximum output frequency is 1.2 KHz or less.

Pr.44 Analog Output Gain Setting

Parameter # 44

Parameter Name Analog output gain setting

Factory Setting d0100%

Units 1%

Parameter value d0001 - d0200%

 This parameter can be programmed while the drive is running.

 This function regulates the voltage level of the analog signal output (frequency or current) at the AFM output terminal, which is then fed to the meter.

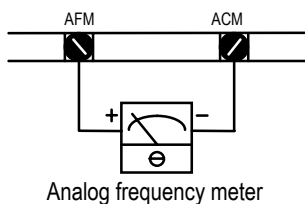

The analog voltage output is proportional to the AC drive output frequency. The AC drive maximum operating frequency (Pr.03) is equivalent to 10 VDC. If necessary, adjust the output level using Pr.44 Analog Output Gain.

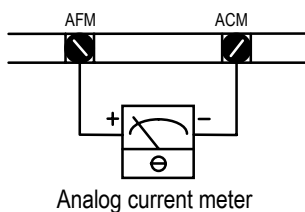

The analog voltage output is proportional to the AC drive output current. 10 VDC of analog voltage is equivalent to 2.5 times the AC drive rated output current. If necessary, adjust the output level using Pr.44 Analog Output Gain.

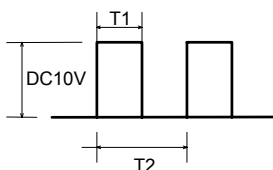
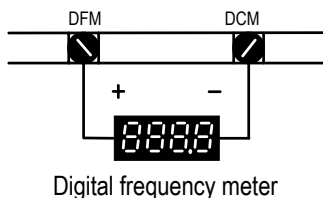

$T1 / T2$ (duty cycle) = 50%

The number of output pulses per second is equal to the output frequency multiplied by [Pr.43].

Note: The digital frequency output should be less than 1.2 KHz.

Pr.45 Pr.46 Multi-function Output Terminal Setting

Parameter #	45 (MO1), 46(MO2)
Parameter Name	Multi-function photocoupled output terminals: MO1, MO2
Factory Setting	d0000, d0001
Units	None
Settings	<ul style="list-style-type: none"> d0000 AC drive operational d0001 Pre-set frequency attained d0002 Desired frequency attained d0003 Count down complete d0004 Non-zero speed d0005 Over-torque detection d0006 Baseblock indicator d0007 Low-voltage detect indicator d0008 AC drive operation mode d0009 Fault indicator

Please see descriptions below.

 Control terminals MO1 and MO2 are open collector outputs. Terminal MCM is signal return (refer to Control Terminal Block description).

 Description

- ① **AC drive operational:** This terminal will be “closed” when there is output from the AC drive or when the FWD or REV run command is input.
- ② **Pre-set frequency attained:** This terminal will be “closed” once the AC drive attained the specified operating frequency.
- ③ **Desired frequency attained:** This terminal will be “closed” once the AC drive attained the desired operating frequency.
- ④ **Count down complete:** This terminal will be “closed” when the AC drive’s internal counter, triggered by the external input TRG, starts countdown and reaches d0001. Set the count down value using Pr.63 and Pr.66.
- ⑤ **Non-zero speed:** This terminal will be “closed” when the AC drive output frequency is greater than the minimum output frequency.
- ⑥ **Over-torque detection:** This terminal will remain “closed” as long as over-torque is detected. Set the over-torque detection level using Pr.61 and the over-torque detection time using Pr.62.
- ⑦ **Baseblock indicator:** This terminal will always be “closed” as long as the AC drive output is turned off.
- ⑧ **Low-voltage detect indicator:** This terminal will be “closed” when the AC drive detects a low voltage state.
- ⑨ **AC drive operation mode:** This terminal will be “closed” when the AC drive is operated by commands via the RS-485 serial interface or control terminals.
- ⑩ **Fault indicator:** This terminal will be “closed” when a major fault is detected.

Pr.47 Desired Frequency Attained Setting

Parameter # 47
Parameter Name Desired frequency attained setting
Factory Setting d000.0 Hz
Units 0.1 Hz
Parameter value d000.0 - d400.0 Hz

 Used to select a specified frequency, set in increments of 0.1 Hz. (See Pr.45, 46)

Pr.48 **Pr.49** Analog Input Setting for Output Frequency Range

Parameter # 48
Parameter Name Maximum output frequency voltage setting
Factory Setting d010.0 V
Units 0.1 V
Parameter value d000.0 - d010.0 V

 This parameter can be programmed while the drive is running.

 Sets the input signal voltage level (0 – 10V) that corresponds to the **maximum output frequency** (Pr.03). Used in conjunction with Pr.49, this parameter may be used to set the analog input for frequency command curve setting. (See graph on next page)

Parameter # 49
Parameter Name Minimum output frequency voltage setting
Factory Setting d000.3 V
Units 0.1 V
Parameter value d000.0 - d010.0 V

 This parameter can be programmed while the drive is running.

 Sets the input signal voltage level (0 – 10V) that corresponds to the **minimum output frequency** (Pr.08). (See graph on next page)

Note: The absolute value of the difference between the settings of Pr.48 and Pr.49 should be greater than or equal to 3.

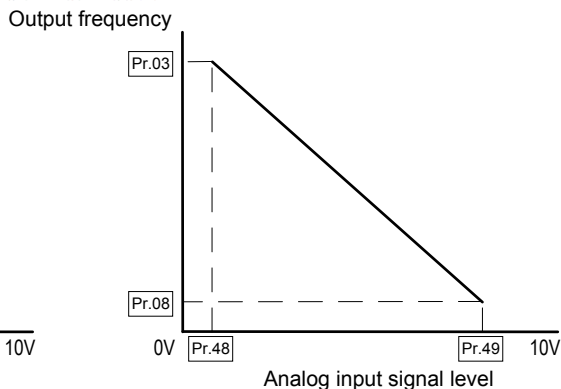
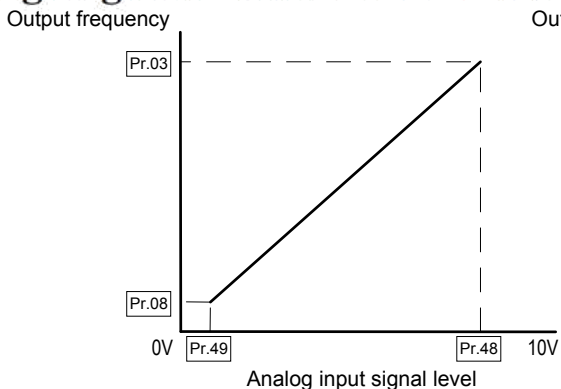

The analog input signal level is the combined input signals from the analog voltage input (AVI) (0 - 10 V) and analog current input (ACI) (4 - 20 mA). The voltage corresponding to the analog current input (4 - 20 mA) and analog input signal level is defined as follows:

Voltage corresponding to the analog input signal level

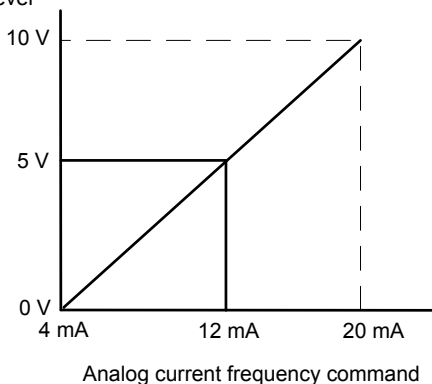

An example of such application may be illustrated as follows:

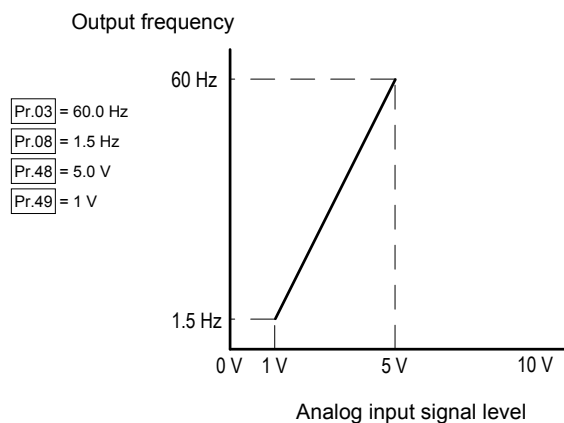
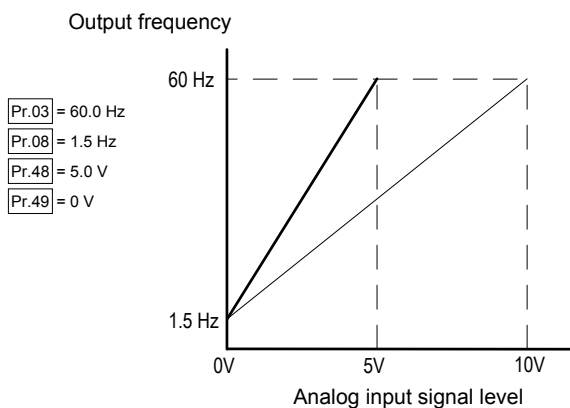

Pr.50 Reserved

Pr.51 Reserved

Pr.52 Pr.53 Motor Current Setting

Parameter # 52
Parameter Name Motor rated current
Factory Setting d0100%
Units 1%
Parameter value d0030 - d0120%

 This parameter can be programmed while the drive is running.

 This parameter must be set according to the motor specification found on its nameplate. This setting will limit the AC drive output current in order to prevent the motor from overheating. When the motor current exceeds this value, the output frequency will be reduced until the current drops below this limit.

Parameter # 53
Parameter Name Motor no-load current
Factory Setting d0040
Units 1%
Parameter value d0000 - d0099%

 This parameter can be programmed while the drive is running.

 This parameter sets the motor no-load current in 1% increments.

Pr.54 Torque Compensation Setting

Parameter # 54
Parameter Name Auto torque-compensation
Factory Setting d0000
Units 1%
Parameter value d0000 - d0010%

 This parameter can be programmed while the drive is running.

 This parameter may be set so that the AC drive will increase the voltage output during startup to obtain a higher initial starting torque. This additional torque will be present until the master operating frequency is attained.

 Be careful while setting the value for Pr.54. If the value is too high, the motor might overheat or be damaged.

Pr.55 Slip Compensation

Parameter #	55
Parameter Name	Slip compensation
Factory Setting	d000.0
Units	0.1%
Parameter value	d000.0 - d010.0%

 This parameter can be programmed while the drive is running.

 This parameter is used to compensate for the nominal slip within a range of 0.0 - 10.0%. When the output current of the AC drive is greater than the motor no-load current (Pr.53), the AC drive will adjust its output frequency according to Pr.55.

 Example: If Pr. 04 is set at 60Hz and Pr. 55 is set at 10%, the drive will increase the output frequency up to 6% under full load conditions to compensate for slip.

Pr.56 Reserved

Pr.57 Multi-function Indication Output Contact

Parameter #	57
Parameter Name	Multi-function indication output contact RA-RC(NO), RB-RC(NC)
Factory Setting	d0000
Settings	d0000 Fault indicator
	d0001 AC drive operational
	d0002 Pre-set frequency attained
	d0003 Desired frequency attained
	d0004 Non-zero speed
	d0005 Over-torque detection
	d0006 Baseblock indicator

 This parameter sets the multi-function programmable relay contact outputs. The contact ratings are 250Vac @ 2A, 30Vdc @ 2A. Set parameter Pr.57 according to the table listed above.

Pr.58 Pr.59 Electronic Thermal Overload Relay

Parameter # 58

Parameter Name Motor derating curve during temperature change

Factory Setting d0002

Units None

Settings d0000 Active with standard motor

d0001 Active with special motor

d0002 Inactive

 To prevent self-cooling motors from over-heating while running at low speeds, this parameter may be set to limit the AC drive output power.

d0000: The electronic thermal characteristics behave in accordance with a reduced torque motor (standard motor).

d0001: The electronic thermal characteristics behave in accordance with a constant torque motor (special motor).

Parameter # 59

Parameter Name Electronic thermal characteristics selection

Factory Setting d0060

Units 1 Sec

Parameter value d0030 - d0300 Sec.

 This parameter determines the time required to activate the I²t electronic thermal protection function. The activation time may be defined according to short, standard and long time ratings.

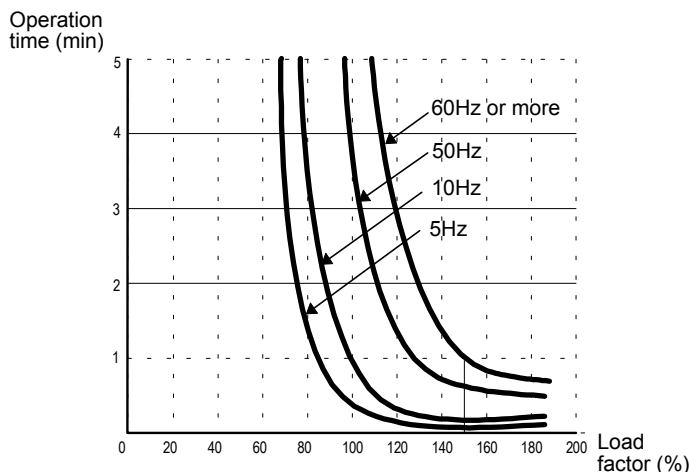

Pr.60 Pr.61 Pr.62 Over-torque Detection Setting

Parameter # 60

Parameter Name Over-torque detection mode select
Factory Setting d0000
Settings d0000 Over-torque detection **not enabled**
 d0001 Over-torque detection during constant speed operation, operation halted after over-torque detection
 d0002 Over-torque detection during constant speed operation, operation continues after over-torque detection
 d0003 Over-torque detection during operation, operation halted after over-torque detection
 d0004 Over-torque detection during operation, operation continues after over-torque detection

 This parameter determines the AC drive operation after an over-torque is detected. Over-torque detection is based on the following: When the output current exceeds the over-torque detection level (Pr.61, factory preset value = 150%) and the over-torque detection time (Pr.62, factory preset value = 0.1 second, hysteresis fixed at 10%). The Multi-function PHC output 1 and 2 may be set to indicate an over-torque condition. Refer to Pr.45, 46. The Multi-function Indication Output (Pr. 57) may also be set to indicate an over-torque condition.

Parameter # 61

Parameter Name Over-torque detection level
Factory Setting d0150
Units 1%
Parameter value d0030 - d0200%

 This parameter sets the over-torque detection level at 1% increments. The AC drive rated current is regarded as 100%.

Parameter # 62

Parameter Name Over-torque detection time
Factory Setting d000.1 Sec
Units 0.1 Sec
Parameter value d000.1 - d010.0 Sec

 This parameter sets the over-torque detection time in units of 0.1 second.

Pr.63 Pre-set Count Down Value Attained Setting

Parameter # 63

Parameter Name Pre-set count down value attained

Factory Setting d0001

Parameter value d0001 - d9999

When the VFD-A internal counter, triggered by the external input TRG, counts down and reaches this specified value, the specified output terminal (MO1) will be closed (assuming that Pr.45 is set to d0003). The output terminal (MO1) will be opened when the internal counter reaches the value specified in Pr.66. (See chart below)

Pr.66 Count Down Value Setting

Parameter # 66

Parameter Name Count down value setting

Factory Setting d0001

Units 1

Parameter value d0001 - d9999

This parameter determines the value of the VFD-A internal counter. The internal counter may be triggered by an external signal via the external input TRG terminal. Upon completion of the countdown, the specified output terminal (MO2) will be closed (assuming that Pr.46 is set to d0003). (See chart below)

The timing chart is illustrated as follows:

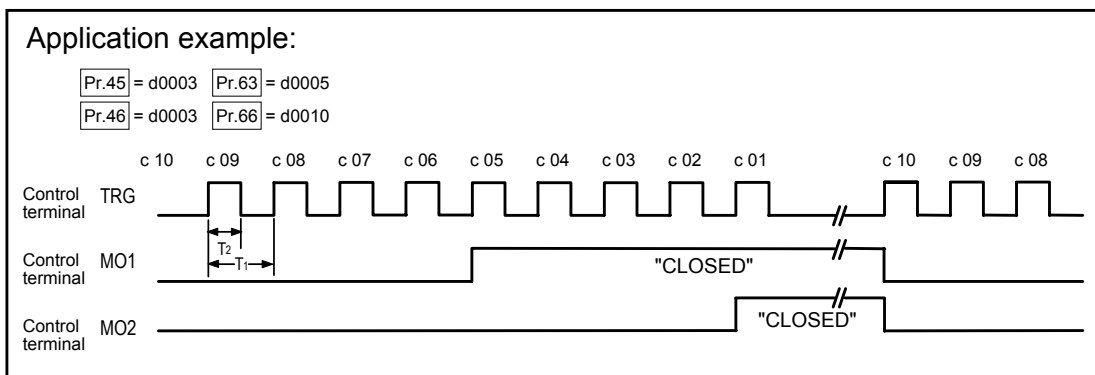

Note: The minimum On time for T2 is 2 msec or more.
The minimum cycle time for T1 is 6 msec. or more.

Pr.64 Function Display Setting

Parameter # 64

Parameter Name Displays the contents of the monitored item

Factory Setting d0000

Settings d0000 Displays the actual operating frequency (H)
 d0001 Displays the user-defined setting (v)
 d0002 Displays the value of the internal counter (c)

 Displays the contents of the monitored item as follows:

- H: Displays the actual operation frequency
- v: Displays the user-defined setting (where $v = H \times \text{Pr.65}$)
- c: Displays the value of the internal counter. This counter is triggered by an external signal provided via the external input TRG. When the counter reaches d0000 during count down, the multi-function output terminal MO1 or MO2 will be “closed” (Refer to Pr.45, 46). The counter will use the value contained in Pr.66 as its starting point when another count down is to be executed.

Pr.65 Coefficient K Setting

Parameter # 65

Parameter Name Coefficient of line speed

Factory Setting d001.0

Units 0.1

Parameter value d000.1 - d200.0

 This parameter can be programmed while the drive is running.

 Coefficient K determines the multiplying factor for the user-defined setting (v).

The value of the user-defined setting (v) is calculated and displayed as follows:
 Display value of $v = \text{output frequency} \times K$. The maximum value that can be displayed is 9999. If the value of v exceeds 9999, the actual value is equal to the display value multiplied by 10.

Pr.67 Pr.68 Pr.69 Pr.70

Skip Frequencies 1 to 3 Setting

Parameter # 67, 68, 69
Parameter Name Skip frequency 1, 2, 3
Factory Setting d000.0 Hz
Units 0.1 Hz
Parameter value d000.1 - d400.0 Hz

 This parameter determines the three skip frequencies, which in conjunction with Pr.70 [Skip Frequency Band] will cause the AC drive to skip operation at these frequency ranges. (See graph below)

Parameter # 70
Parameter Name Skip frequency band
Factory Setting d000.1
Units 0.1 Hz
Parameter value d000.1 - d020.0 Hz

 This parameter determines the frequency band of a given [Skip frequency]. The actual band is 2 x Skip frequency band, half of which is above and the other half is below the [Skip frequency] setting. Setting this parameter to 0.1 to disable all skip frequencies. (See graph below)

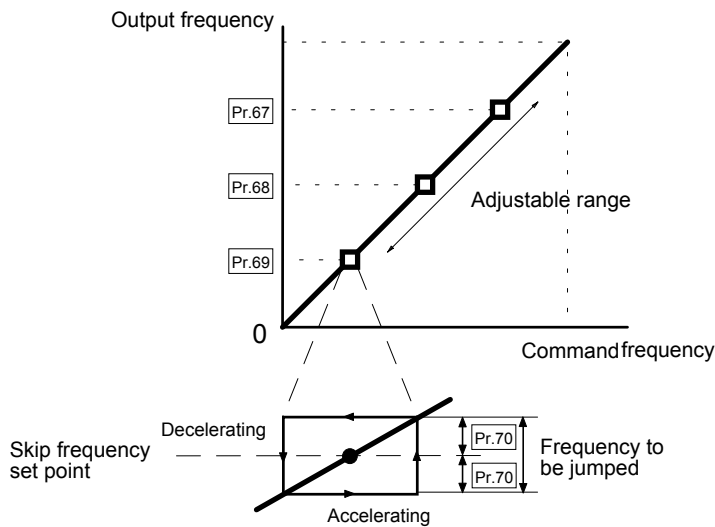

Pr.71 PWM Frequency Setting

Parameter # 71

Parameter Name PWM frequency setting

Factory Setting d0005

Settings d0001 fc = 3 KHz
 d0002 fc = 6 KHz
 d0003 fc = 9 KHz
 d0004 fc = 12 KHz
 d0005 fc = 15 KHz

 This parameter determines the carrier frequency for the PWM (Pulse Width Modulation) output.

Carrier frequency	Acoustic noise	Leakage current	Heat dissipation
3 KHz	significant ↑	minimal ↑	minimal ↑
6 KHz			
9 KHz	↓	↓	↓
12 KHz			
15 KHz			

Note: For AC drives rated below 7.5 KW (10HP), the output current derating applies above 9 KHz. For AC drives rated 7.5KW and above, the output current derating applies above 12KHz. See figure below:

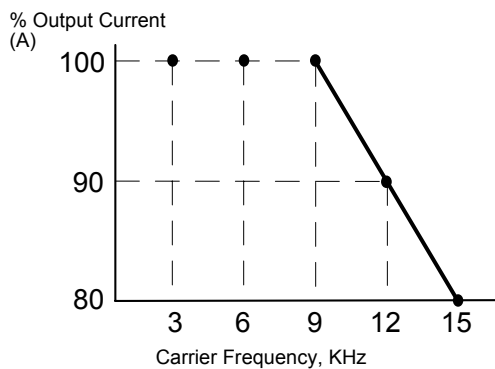

Pr.72 Auto Reset / Restart Operation after Fault

Parameter # 72

Parameter Name Auto reset / restart operation after fault

Factory Setting d0000

Parameter value d0000 - d0010

 Reset / restart operation may be performed up to 10 times after a fault has occurred. Setting this parameter to 0 disables the reset / restart operation after any fault has occurred. If a protective shut-down operation (oc, ov) occurs during operation, the auto reset / restart function can be selected. (Refer to Fault Names in Ch. 7)

Pr.73 Pr.74 Pr.75 Fault Records

Parameter #	73, 74, 75
Parameter Name	Three most recent fault records
Factory Setting	d0000
Settings	d0000
	d0001 Over-current (oc)
	d0002 Over-voltage (ov)
	d0003 Overheat (oH)
	d0004 Overload (oL)
	d0005 Overload 1 (oL1)
	d0006 External fault (EF)
	d0007 CPU failure 1 (CF1)
	d0008 CPU failure 3 (CF3)
	d0009 Hardware protection failure (HPF)
	d0010 Over-current during acceleration (ocA)
	d0011 Over-current during deceleration (ocd)
	d0012 Over-current during steady state operation (ocn)
	d0013 Ground fault or fuse failure (GFF)
	d0014 Manufacturer-used diagnostics
	d0015 Manufacturer-used diagnostics
	d0016 Manufacturer-used diagnostics
	d0017 External baseblock (bb)
	d0018 Overload 2 (oL2)
	d0019 Manufacturer-used diagnostics
	d0020 Manufacturer-used diagnostics

 These parameters store records of the three most recent faults that have occurred.

Pr.76 Keypad Lockout / Reset

Parameter #	76
Parameter Name	Keypad Lockout / Reset
Factory Setting	d0000
Settings	d0000 All parameters can always be set and read
	d0001 All parameters are read-only
	d0002 - d0009 Not used
	d0010 Resets all parameters to the factory defaults

 This setting determines the access to the parameters and allows the user to return all parameters to the factory default settings.

Pr.77 Baud Rate

Parameter # 77	
Parameter Name	Special function parameter
Factory Setting	d0000
Settings	d0000 1200 baud (Data rate bps)
	d0001 2400 baud (Data rate bps)
	d0002 4800 baud (Data rate bps)

 This parameter sets the communication baud rate between the personal computer and the AC drive. A personal computer may be connected to the AC drive via its RS-485 serial port. The PC may then be used to set or modify the internal parameters of the AC drive, or to control and monitor the AC drive operation. Thirty-two AC drives may be connected simultaneously to a personal computer.

Pr.78 Slave Address

Parameter # 78	
Parameter Name	Slave address
Factory Setting	d0000
Units	None
Parameter value	d0000 - d0031

 If the VFD-A is to be operated by remote control via the RS-485 serial interface, the bus address should be specified using this parameter.

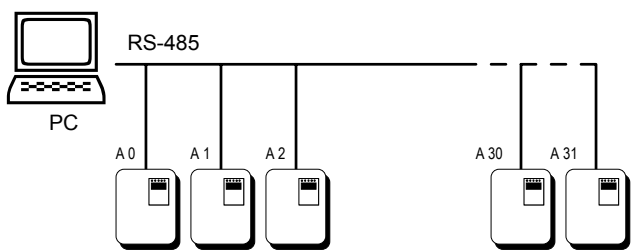

 A personal computer may be used to load, change, or monitor the parameter value through the PC's RS-485 interface, which permits communication with higher-level automation systems.

Pr.79 Reserved

Pr.80 Manufacturer-used Function

 This parameter displays the firmware version number of the AC drive, which may vary according to the software version and AC drive system number.

 This parameter is read only.

Summary of Parameter Settings

This chapter summarizes all the 10 groups of parameters. The page number shown in parenthesis will direct you to the explanation of settings associated with each parameter.

NO.	Parameter Name	Function Explanation	Parameter Value	Factory Setting
00	Command frequency source select (page 20)	Command frequency source select	d0000: Command frequency input determined by the digital control panel	d0000
			d0001: Command frequency input determined by the analog signal (DC 0 to +10 V) + (DC 4 to 20 mA)	
			d0002: Command frequency input determined by remote control via the RS-485 serial interface	
01	Operation Command source (page 21)	Operation command source select	d0000: Operating instructions determined by the digital control panel	d0000
			d0001: Operating instructions determined by the external terminal connections, keypad STOP key effective	
			d0002: Operating instructions determined by the external terminal connections, keypad STOP key not effective	
			d0003: Operating instructions determined by the RS-485 serial interface, keypad STOP key effective	
			d0004: Operating instructions determined by the RS-485 serial interface, keypad STOP key not effective	
02	Motor stop method (page 20)	Motor stop method	d0000: RAMP stop	d0000
			d0001: Coasting to stop	
03	V / F curve setting (page 21)	Max. operating	d050.0 - d400.0 Hz	d060.0
04		Max. voltage frequency	d010.0 - d400.0 Hz	d060.0
05		Max. output voltage	d002.0 - d255.0 V	d220.0
06		Mid-point frequency	d000.1 - d400.0 Hz	d001.5
07		Mid-point voltage	d002.0 - d255.0 V	d010.0
08		Min. output frequency	d000.1 - d020.0 Hz	d001.5
09		Min. output voltage	d002.0 - d050.0 V	d010.0

NO.	Parameter Name	Function Explanation	Parameter Value	Factory Setting
10	Accel / decel time Setting (page 24)	Acceleration time 1	d000.1 - d600.0 sec	d010.0
11		Deceleration time 1	d000.1 - d600.0 sec	d010.0
12		Acceleration time 2	d000.1 - d600.0 sec	d010.0
13		Deceleration time 2	d000.1 - d600.0 sec	d010.0
14	Jog accel / decel time (page 25)	Jog accel / decel time select	d000.1 - d600.0 sec	d010.0
15	S-curve (page 26)	S-curve setting	d0000 - d0007	d0000
16	Multi-step speed operation (page 26)	Multi-step speed setting 1	d000.0 - d400.0 Hz	d000.0
17		Multi-step speed setting 2	d000.0 - d400.0 Hz	d000.0
18		Multi-step speed setting 3	d000.0 - d400.0 Hz	d000.0
19		Multi-step speed setting 4	d000.0 - d400.0 Hz	d000.0
20		Multi-step speed setting 5	d000.0 - d400.0 Hz	d000.0
21		Multi-step speed setting 6	d000.0 - d400.0 Hz	d000.0
22		Multi-step speed setting 7	d000.0 - d400.0 Hz	d000.0
23	Jog frequency (page 27)	Jog frequency select	d000.1 - d400.0 Hz	d006.0
24	REV run setting (page 27)	REV run	d0000: REV run enable	d0000
			d0001: REV run disable	
25	Over-voltage stall prevention (page 28)	Over-voltage stall prevention	d0000: Disable over-voltage stall prevention	d0001
			d0001: Enable over-voltage stall prevention	
26	Over-current stall prevention (page 28)	Over-current stall prevention during acceleration	d0050 - d0200 %	d0170
27		Over-current stall prevention during operation	d0050 - d0200 %	d0170
28	DC braking current setting (page 30)	DC braking current	d0000 - d0100%	d0000
29		DC braking time during start-up	d000.0 - d005.0 sec	d000.0
30		DC braking time during stopping	d000.0 - d025.0 sec	d000.0
31		DC braking start-up frequency	d000.0 - d060.0 Hz	d000.0
32	Momentary power loss protection (page 31)	Momentary power failure operation mode selection	d0000: Operation stops after momentary power Loss.	d0000
			d0001: Operation continues after momentary power loss. Speed search starts with the frequency reference value.	
			d0002: Operation continues after momentary power loss. Speed search starts with the minimum output frequency.	

NO.	Parameter Name	Function Explanation	Parameter Value	Factory Setting	
33		Maximum allowable power loss time	d000.3 - d005.0 sec	d002.0	
34		Minimum base block time	d000.3 - d005.0 sec	d000.5	
35		Speed search current limit	d0030 - d0200 %	d0150	
36	Reference freq. upper / lower limit	Reference frequency upper limit setting	d000.1 - d400.0 Hz	d400.0	
37	setting (page 32)	Reference frequency lower limit setting	d000.0 - d400.0 Hz	d000.0	
38	External control terminal setting (page 33)	2-wire / 3-wire operation control selection	d0000: FWD / STOP, REV / STOP d0001: FWD / REV, RUN / STOP d0002: 3-WIRE operation control mode	d0000	
39	Multi-function input terminal setting (page 34)	Multi-function input 1	d0000: Multi-step speed command 1	d0000	
40		Multi-function input 2	d0001: Multi-step speed command 2	d0001	
41		Multi-function input 3	d0002: Multi-step speed command 3	d0002	
			d0003: Jog frequency reference select		
			d0004: Accel / decel speed inhibit command		
			d0005: First and second accel/decel time select		
			d0006: External baseblock (NO- contact input)		
			d0007: External baseblock (NC- contact input)		
		d0008: Up command			
		d0009: Down command			
42	Analog meter output select (page 35)	Analog output select	d0000: Analog frequency meter (0 to Maximum Frequency) d0001: Analog current meter (0 to 250% of the rated drive output current)	d0000	
43	Digital output frequency multiplier factor (page 35)	Digital output frequency multiplier select	d0001 - d0020	d0001	
44	Analog output gain setting (page 36)	Analog output gain select	d0001 - d0200 %	d0100	
45	Multi-function output terminal setting (page 37)	Multi-function output terminal 1 (MO1)	d0000: AC drive operational	d0000	
			d0001: Pre-set frequency attained		
46		Multi-function output terminal 2 (MO2)		d0002: Desired frequency attained	d0001
				d0003: Count down complete	
				d0004: Non-zero speed	
				d0005: Over-torque detection	
				d0006: Baseblock indicator	
				d0007: Low-voltage detect indicator	
	d0008: AC drive operation mode				
	d0009: Fault indicator				
47	Desired frequency attained setting (page 38)	Desired frequency attained	d000.0 - d400.0 Hz	d000.0	

NO.	Parameter Name	Function Explanation	Parameter Value	Factory Setting
48	Analog input for output frequency range (page 38)	Max. output frequency voltage setting.	d000.0 - d010.0 V	d010.0
49		Min. output frequency voltage setting.	d000.0 - d010.0 V	d000.3
50	Reserved			
51	Reserved			
52	Motor current setting (page 40)	Motor rated current	d0030 - d0120 %	d0100
53		Motor no-load current	d0000 - d0099 %	d0040
54	Torque compensation setting (page 40)	Auto torque compensation gain	d0000 - d0010 %	d0000
55	Slip compensation (page 41)	Slip correction compensation	d000.0 - d010.0 %	d000.0
56	Reserved			
57	Multi-function indication output contact RA-RC (NO) RB-RC (NC) (page 41)		d0000: Fault indicator	d0000
			d0001: AC drive operational	
			d0002: Pre-set frequency attained	
			d0003: Desired frequency attained	
			d0004: Non-zero speed	
			d0005: Over-torque detection	
d0006: Baseblock indicator				
58	Electronic thermal overload relay (page 42)	Motor current derated by temperature.	d0000: Active with standard motor	d0002
			d0001: Active with special motor	
			d0002: Inactive	
59	Electronic thermal characteristics selection (42)		d0030 d0300 sec	d0060
60	Over-torque detection setting (page 43)	Over-torque detection mode select	d0000: Over-torque detection not enabled	d0000
			d0001: Over-torque detection during constant speed operation, operation halted after over-torque	
			d0002: Over-torque detection during constant speed operation, operation continues after over-torque detection	
			d0003: Over-torque detection during operation, operation halted after over-torque	
			d0004: Over-torque detection during operation, operation continues after over-torque detection	
61		Over-torque detection	d0030 d0200 %	d0150
62		Over-torque detection time	d000.1 d010.0 sec	d000.1
64	Function display setting (page 45)	Function Display Setting	d0000: Displays the actual operating freq. (H)	d0000
			d0001: Displays the user-defined setting (v)	
			d0002: Displays the value of the internal Counter (c)	
65	Coefficient K setting for line speed (page45)		d000.1 d200.0	d001.0

NO.	Parameter Name	Function Explanation	Parameter Value	Factory Setting	
63	Pre-set count down setting	(page 44)	d0001 - d9999	d0001	
66	Count down value setting	(page 44)	d0001 - d9999	d0001	
67	Skip frequencies 1 to 3 setting (page 46)	Skip Frequency 1	d000.0 - d400.0 Hz	d000.0	
68		Skip Frequency 2	d000.0 - d400.0 Hz	d000.0	
69		Skip Frequency 3	d000.0 - d400.0 Hz	d000.0	
70		Skip Frequency Band	d000.1 - d020.0 Hz	d000.1	
71	PWM Frequency setting (page 47)	Carrier frequency select	d0001: <i>fc</i> = 3 KHz, d0002: <i>fc</i> = 6 KHz d0003: <i>fc</i> = 9 KHz, d0004: <i>fc</i> = 12 KHz d0005: <i>fc</i> = 15 KHz	d0005	
72	Auto reset/restart operation after fault (page47)		d0000 - d0010	d0000	
73	Fault records (page 48)	Most recent fault record	d0000: Fault records clear (No errors occurred)	d0000	
74		Second most recent fault record	d0001: Over-current (oc)	d0000	
75		Third most recent fault record	d0002: Over-voltage (ov)	d0000	
				d0003: Overheat (oH)	
				d0004: Overload (oL)	
				d0005: Overload 1 (oL1)	
				d0006: External fault (EF)	
				d0007: CPU failure 1 (CF1)	
				d0008: CPU Failure 3 (CF3)	
				d0009: Hardware protection failure (HPF)	
				d0010: O.C. during acceleration (ocA)	
				d0011: O.C. during deceleration (ocd)	
				d0012: O.C. during steady state operation (ocn)	
			d0013: Ground fault or fuse failure (GFF)		
			d0014-16: Manufacture used diagnostics		
			d0017: External baseblock (bb)		
			d0018: Overload 2 (oL2)		
			d0019-20: Manufacture used diagnostics		
76	Keypad lockout (page 48)	Keypad lockout or reset	d0000: All parameters can always be set and read	d0000	
			d0001: All parameters are read-only		
			d0002-d0009: not used		
			d0010: Resets all parameters to the factory defaults		
77	Baud rate (page 49)	Data rate in bos	d0000: 1200 baud (Data rate bps)	d0002	
			d0001: 2400 baud (Data rate bps)		
			d0002: 4800 baud (Data rate bps)		
78	Slave address (page49)		d0000-d0031	d0000	
79	Reserved				
80	AC motor drive model number and software version (page 50)				

Troubleshooting and Fault Information

The AC drive has a comprehensive fault diagnosis system that includes more than 20 different alarms and fault messages. Once a fault is detected, the corresponding protective functions will be activated to turn off the AC drive output. The various AC drive failures may be classified as follows:

- **Over Voltage / Low Voltage**
- **Heat sink Over Temperature**
- **Motor Overload**
- **AC drive Overload**
- **Motor Stalled**
- **Microprocessor Systems Failure**

The three most recent faults are stored in the AC drive non-volatile memory and may be read through the digital keypad, or through the RS-485 interface on the control board.

Troubleshooting and Fault Information

This section provides information to guide the user in understanding the various AC drive fault conditions and their general troubleshooting procedures. A listing and description of the different AC drive failures is given, along with their possible solutions. A section on general troubleshooting is also included for reference.

Important: Pressing the Reset button will not restore the AC drive to its normal operating conditions unless the fault is corrected. During any failure, the AC drive switches off and an error message will appear in the display. The last error that occurred is stored in Pr.73.

Common Problems and Solutions

Fault Name	Fault Descriptions	Corrective Actions
<i>O.C.</i>	The over-current hardware trip circuit detects an abnormal increase in current.	<p>Check whether the motor output power corresponds to the AC drive output power.</p> <p>Check the wiring connections between the AC drive and motor for possible short circuits.</p> <p>Increase the Acceleration time 1 and 2 (Pr. 10, 12).</p> <p>Check for possible excessive loading conditions at the motor.</p> <p>After short-circuit being removed, if there is any abnormal conditions when operating the AC Motor Drive, it should be sent back to the agency or manufacturer.</p>
<i>O.V.</i>	The AC drive detects that the DC bus voltage has exceeded its maximum allowable value.	<p>Check whether the input voltage falls within the rated AC drive input voltage. Check for possible voltage transients.</p> <p>Bus over-voltage may also be caused by motor regeneration. Either increase the Decel time or add an optional braking resistor. Check whether the required braking power is within the specified limits.</p>
<i>O.H.</i>	The AC drive temperature sensor detects excessive heat.	<p>Ensure that the ambient temperature falls within the specified temperature range.</p> <p>Make sure that the ventilation holes are not obstructed.</p> <p>Remove any foreign objects on the heatsinks and check for possible dirty heatsink fins.</p> <p>Provide enough spacing for adequate ventilation.</p>
<i>L.V.</i>	The AC drive detects that the DC bus voltage has fallen below its minimum value.	Check whether the input voltage falls within the rated AC drive's input voltage.
<i>O.L.</i>	<p>The AC drive detects excessive drive output current.</p> <p>The AC drive can withstand up to 150% of the rated current for a maximum of 60 seconds.</p>	<p>Check whether the motor is overloaded.</p> <p>Reduce the torque compensation setting as set in Pr.54.</p> <p>Increase the AC drive's output capacity.</p>

Fault Name	Fault Descriptions	Corrective Actions
<i>oL1</i>	Internal electronic overload trip: Motor is overloaded. Reduce the current level so that the drive output current does not exceed the value set by the [Motor rated current] Pr.52.	Check for possible motor overload. Check electronic thermal overload setting. Increase motor capacity.
<i>oL2</i>	Motor overload. Check the parameter settings Pr.60, 62.)	Reduce the motor load. Adjust the over-torque detection setting to an appropriate setting.
<i>ocA</i>	Over-current during acceleration: 1. Short-circuit at motor output. 2. Torque boost too high. 3. Acceleration time too short. 4. AC drive output capacity too small.	Check for possible poor insulation at the output line. Decrease the torque boost setting in Pr.-54. Increase the acceleration time. Replace with an AC drive with higher output capacity.
<i>ocd</i>	Over-current during deceleration: 1. Short-circuit at motor output. 2. Deceleration time too short. 3. AC drive output capacity too small.	Check for possible poor insulation at the output line. Increase the deceleration time. Replace with an AC drive with higher output capacity.
<i>ocn</i>	Over-current during steady state operation: 1. Short-circuit at motor output. 2. Sudden increase in motor loading. 3. AC drive output capacity too small.	Check for possible poor insulation at the output line. Check for possible motor stall. Replace with an AC drive with higher output capacity.
<i>EF</i>	The external terminal EF-DCM goes from ON to OFF.	External fault.
<i>cf1</i>	AC drive internal circuitry failure.	1. Switch off power supply. 2. Check whether the input voltage falls within the rated AC drive input voltage. 3. Switch the AC drive back on.

Fault Name	Fault Descriptions	Corrective Actions
<i>c.F.2</i>	AC drive E ² PROM contains invalid data or can not be programmed.	Check the connections between the main control board and the power board. Reset drive to factory defaults.
<i>G.F.F.</i>	Ground fault or fuse failure: Ground fault : The AC drive output is abnormal. When the output terminal is grounded (short circuit current is 50% more than the AC drive rated current), the AC drive power module may be damaged. The short circuit protection is provided for the AC drive protection, not user protection.	Ground fault : 1. Check whether the IGBT power module is damaged. 2. Check for possible poor insulation at the output line.
	Fuse failure: The fuse failure information will be displayed by the LED located on the power board.	Fuse failure: 1. Replace Fuse. 2. Check whether the IGBT power module is damaged. 3. Check for possible poor insulation at the output line.
<i>b.b.</i>	External baseblock. AC drive output is turned off.	When the multi-function input 1 (2, 3)-DCM terminal goes from OFF to ON, the AC drive output will be turned off.
<i>c.F.3</i>	Drive's internal circuitry abnormal.	Switch off power supply. Check whether the input voltage falls within the rated AC drive input voltage. Switch on the AC drive.
<i>H.P.F</i>	Protection circuitry of hardware detected abnormal operation.	Remove power from the AC drive and then restore power. If H.P.F. fault appears again, the AC drive should be returned for service.

APPENDIX **A**

Standard Specifications

Voltage classification		230V										
Model name VFD-□□□		007*	015*	022*	037	055	075	110	150	185	220	
3 Phase motor rating (KW)		0.75	1.5	2.2	3.7	5.5	7.5	11.0	15.0	18.5	22.0	
3 Phase motor rating (HP)		1.0	2.0	3.0	5.0	7.5	10.0	15.0	20.0	25.0	30.0	
Output Rating	Inverter output (KVA)	1.9	2.5	4.2	6.5	9.5	12.5	17.5	22.8	28.6	33.2	
	Output current (A)	5.0	6.5	11	17	25	33	46	60	75	87	
	Output voltage (V)	Adjustable from 0 to input voltage										
	Output frequency (Hz)	Programmable from 0 to 400 Hz										
Input Rating	Rated AC input power supply	200 / 208/ 220 / 240 VAC, three phase, 50 / 60Hz										
	Single (3-phase Input Current)	6.8	8.9	14.3								
	Input Current (A)	7.4	9.9	15.5	19.6	33.5	43.3	46	76	83	99	
	Operational range (V)	180~265 VAC, 47~63 Hz										
	Power factor (Displacement)	0.8 (Lagging)										
Control Characteristics	Control system	Sinusoidal PWM control										
	Frequency control range	0.1~400.0 Hz										
	Frequency setting resolution	0.1 Hz										
	Output frequency resolution	0.1 Hz										
	Overload current rating	150% of rated current for 1 minute										
	Acceleration / deceleration time	0.1~600.0 Sec										
	Torque characteristics	Starting torque 150% or more (at 5 Hz)										
	Regenerative braking	Incorporate regenerative braking circuit										
	V / F pattern	Any V / F pattern setting										
	Stall prevention level	Setting to percentage of rated current										
	Operating Characteristics	Frequency setting	Digital operation	Setting by ▲ , ▼ or JOG								
External signal			Variable resistor of 5K/ 0.5W, 0 to 10 VDC, 4~20mA, RS-485 serial port, Multi-function 1~3(JOG, Multi-step speed, Up / Down)									
Operation Setting Signal		Digital operation	Setting by RUN, STOP, FWD / REV									
		External signal	FWD, REV, EF can be combined for 2 or 3-wire operation, RS-485 serial interface.									
Multi-function input signal		Multi-step selection 1 ~7, Jogging, Accel. / Decel. Prohibit, First / Second Accel. / Decel. Switching command, External BB (NC, NO selection), etc.										
Multi-function output signal		During running, Up to frequency setting, Up to desired frequency setting Count out detection, Non zero-speed, Over-torque detection, etc.										
Analog / Digital Output		Analog frequency / current signal output, digital frequency signal output										
Other functions	Automatic Voltage Regulation (AVR), S-Curve, over voltage, over-current stall prevention, abnormal records checking, Carrier-frequency adjustable, DC braking, DB starting frequency setting, Momentary power failure restart, Frequency limit, etc.											
Protective function	Over-current, over voltage, under voltage, electronic thermal, overheat ground fault, overload limit, over voltage supply, etc., but no short-circuit protection of output terminals.											
Cooling Method	Forced air-cooling											
Environments	Installation site	Altitude 1,000m or lower, keep from corrosive gasses, liquid and dust										
	Pollution Degree	2										
	Ambient temperature	-10°C ~ 40°C (-10°C~50°C without blind plate) at rated voltage and rated current.										
	Storage temperature	-20°C ~ 60°C										
	Ambient Humidity	Below 90% RH (non-condensing)										
Vibration	1.0G less than 20Hz, 0.6G at 20~50Hz											
Options	EG2010A extension cable, LC-A05E, LC-A10E digital keypad, RC-01 remote control unit, MVR / MHR Braking resistor											

* Only 220V Series, 0.75~2.2Kw provide single-phase input.

Note 1: The frequency can be reached to 1500Hz by VFD-H Series AC Motor Drives.

Note 2: 11Kw~22Kw models, exclude inherent braking transistor, external braking is optional.

Voltage classification		460V										
Model name VFD-□□□□		007	015	022	037	055	075	110	150	185	220	
3 Phase motor rating (KW)		0.75	1.5	2.2	3.7	5.5	7.5	11.0	15.0	18.5	22.0	
3 Phase motor rating (HP)		1.0	2.0	3.0	5.0	7.5	10.0	15.0	20.0	25.0	30.0	
Output Rating	Inverter output (KVA)	2.3	3.2	4.2	6.3	9.9	13.7	18.3	24.4	28.9	34.3	
	Output current (A)	3	4.2	5.5	8.2	13	18	24	32	38	45	
	Output voltage (V)	Adjustable from 0 to input voltage										
	Output frequency (Hz)	Programmable from 0 to 400 Hz										
Input Rating	Rated AC input power supply	380 / 400 / 415 / 480 VAC, three phase, 50 / 60Hz										
	Input Current (A)	4.2	4.3A 5.8	4.3B 6.0	7.2	8.5	14.0	20.6	28	30	39	49
	Operational range (V)	340~500 VAC, 47~63 Hz										
	Power factor (Displacement)	0.8 (Lagging)										
Control Characteristics	Control system	Sinusoidal PWM control										
	Frequency control range	0.1~400.0 Hz										
	Frequency setting resolution	0.1 Hz										
	Output frequency resolution	0.1 Hz										
	Overload current rating	150% of rated current for 1 minute										
	Acceleration / deceleration time	0.1~600.0 Sec										
	Torque characteristics	Starting torque 150% or more (at 5 Hz)										
	Regenerative braking	Incorporate regenerative braking circuit										
	V / F pattern	Any V / F pattern setting										
	Stall prevention level	Setting to percentage of rated current										
Operating Characteristics	Frequency setting	Digital operation	Setting by ▲ , ▼ or JOG									
		External signal	Variable resistor of 5K/ 0.5W, 0 to 10 VDC, 4~20mA, RS-485 serial port, Multi-function 1~3(JOG, Multi-step speed, Up / Down)									
	Operation Setting Signal	Digital operation	Setting by RUN, STOP, FWD / REV									
		External signal	FWD, REV, EF can be combined for 2 or 3-wire operation, RS-485 serial interface.									
	Multi-function input signal	Multi-step selection 1 ~7, Jogging, Accel. / Decel. Prohibit, First / Second Accel. / Decel. Switching command, External BB (NC, NO selection), etc.										
	Multi-function output signal	During running, Up to frequency setting, Up to desired frequency setting Count out detection, Non zero-speed, Over-torque detection, etc.										
Analog / Digital Output		Analog frequency / current signal output, digital frequency signal output										
Other functions		Automatic Voltage Regulation (AVR), S-Curve, over voltage, over-current stall prevention, abnormal records checking, Carrier-frequency adjustable, DC braking, DB starting frequency setting, Momentary power failure restart, Frequency limit, etc.										
Protective function		Over-current, over voltage, under voltage, electronic thermal, overheat ground fault, overload limit, over voltage supply, etc., but no short-circuit protection of output terminals.										
Cooling Method		Forced air-cooling										
Environments	Installation site	Altitude 1,000m or lower, keep from corrosive gasses, liquid and dust										
	Pollution Degree	2										
	Ambient temperature	-10°C~ 40°C (-10°C~50°C without blind plate) at rated voltage and rated current.										
	Storage temperature	-20°C~60°C										
	Ambient Humidity	Below 90% RH (non-condensing)										
Vibration		1.0G less than 20Hz, 0.6G at 20~50Hz										
Options		EG2010A extension cable, LC-A05E, LC-A10E digital keypad, RC-01 remote control unit, MVR / MHR Braking resistor										

Note 1: The frequency can be reached to 1500Hz by VFD-H Series AC Motor Drives.

Note 2: 11Kw~22Kw models, exclude inherent braking transistor, external braking is optional.

APPENDIX B

Serial Communications

The different AC motor drive parameters can be programmed and displayed by remote control via the RS-485 serial interface. A personal computer may be used to load, change, or monitor the parameter value through the PC's RS-485 interface, which permits communication with higher-level automation systems. This appendix describes the following:

- **Computer Control**
- **Data Format and Protocol**
- **Character Delay Time and Response Delay Time**

Computer Control

The VFD-A series AC motor drive has a built in RS-485 serial communication port on its control terminal block marked SG+, SG-. The two connector pins are defined as follows:

- SG + : Signal +
- SG - : Signal -

Each VFD-A AC motor drive has a pre-assigned slave address specified by Pr.-78. The computer may select any AC drive according to this slave address. The computer may also control all of the AC drives connected to it when the "A" code in command string is 02H.

Data Format and Protocol

- **Data Format**
 - ✓ Baud Rate (Transmission speed in bits per second)
 - ✓ Range of values: 1200, 2400, 4800 Baud (See Pr.-77)
 - ✓ Eleven (11) bits are required to represent each character, as shown in the following example:

Number of bits	Function
1	start bit
8	data bits
1	odd parity bit
1	stop bit

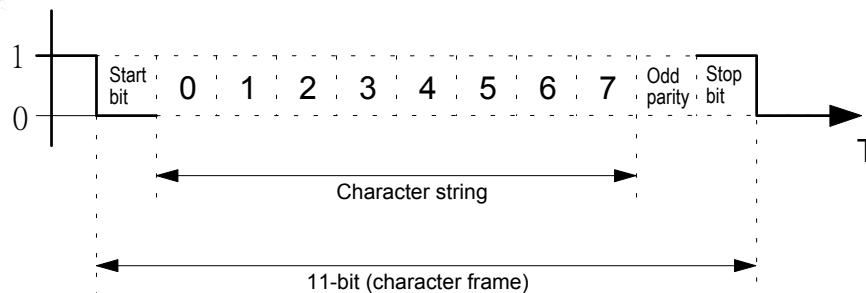

● Protocol

- ☑ Control Command

COMMAND STRUCTURE

"C,S,A,UU,MM,FFFF"

Word length = 11 characters



COMPUTER TO AC MOTOR DRIV

C: Header of control string

S: Check sum (03H)

A: Command acknowledge

01H: Command acknowledged by a single AC drive

02H: Command acknowledged by all AC drives

UU: Slave address ("00" - "31")

MM: Operation command (X = don't care)

X0 Stop

X1 Forward running

X2 Stop

X3 Reverse running

X4, X5 Jog (FWD)

X6, X7 Jog (REV)

X8 Reset after AC drive error

FFFF Frequency command, Setting range: from 0000 (0.0Hz) to 4000 (400.0Hz)

Example: A setting of "1234" = 123.4 Hz

The AC drive will return a character string, the format of which will be as follows:

COMMAND STRUCTURE

"C,S,B,UU,MM,FFFF"

Word length = 11 characters



AC MOTOR DRIVE TO COMPUTER

C: Header of control string

S: Check sum (03H)

B: Acknowledge back

Correct: 06H

Error: 07H

UU: Slave address ("00" - "31")

MM: Operation command (X = don't care)

- X0 Stop
- X1 Forward running
- X2 Stop
- X3 Reverse running
- X4, X5 Jog (FWD)
- X6, X7 Jog (REV)
- X8 Reset after AC drive error
- FFFF Frequency command, Setting range: from 0000 (0.0Hz) to 4000 (400.0Hz)
Example: A setting of "1234" = 123.4 Hz

Parameter Setting Command

COMMAND STRUCTURE

"P,S,A,UU,NN,DDDD"

Word length = 11 characters



COMPUTER TO AC MOTOR DRIV

- P: Header of parameter string
- S: Check sum (03H)
- A: Command acknowledge
 - 01H: Command acknowledged by a single AC drive
 - 02H: Command acknowledged by all AC drives
- UU: Slave address ("00" - "31")
- NN: Parameter number ("00" "80")
- DDDD: Data of parameter

The AC drive will return a character string, the format of which will be as follows:

COMMAND STRUCTURE

"P,S,B,UU,NN,DDDD"

Word length = 11 characters



AC MOTOR DRIVE TO COMPUTE

- P: Header of parameter string
- S: Check sum (03H)
- B: Acknowledge back
 - Correct: 06H
 - Error: 07H
- UU: Slave address ("00" - "31")
- NN: Parameter number ("00" "80")
- DDDD: Data of parameter

Parameter Read Command

COMMAND STRUCTURE

"R,S,A,UU,NN"

Word length = 7 characters



COMPUTER TO AC MOTOR DRIV

- R: Header of read string
- S: Check sum (03H)
- A: Command acknowledge
 - 01H: Command acknowledged by a single AC drive
 - 02H: Command acknowledged by all AC drives
- UU: Slave address ("00" - "31")
- NN: Parameter number ("00" "80")

The AC drive will return a character string, the format of which will be as follows:

COMMAND STRUCTURE

"R,S,B,UU,NN,DDDD"

Word length = 11 characters



AC MOTOR DRIVE TO COMPUTE

- R: Header of read string
- S: Check sum (03H)
- B: Acknowledge back
 - Correct: 06H
 - Error: 07H
- UU: Slave address ("00" - "31")
- NN: Parameter number ("00" "80")
- DDDD: Data of parameter

AC drive Status Read Command

COMMAND STRUCTURE

"Q,S,A,UU,NN"

Word length = 7 characters



COMPUTER TO AC MOTOR DRIV

- Q: Header of question string
- S: Check sum (03H)
- A: Command acknowledge
 - 01H: Command acknowledged by a single AC drive
 - 02H: Command acknowledged by all AC drives
- UU: Slave address ("00" - "31")
- NN: Retrieve contents of drive status. (x = don't care)
 - X0: Frequency command
 - X1: Output frequency
 - X2: Output current
 - X3: Operation command Drive status and Error code

1	0	0	0	Jog speed command
1	0	0	1	Analog input freq. command
1	0	1	0	RS-485 serial interface
1	0	1	1	Up/Down control

CD: Error code

Code	Fault Name
0	No error
01	Over-current (oc)
02	Over voltage (ov)
03	Overheat (oH)
04	Overload (oL)
05	Overload 1 (oL1)
06	External fault (EF)
07	CPU fault 1 (cF1)
08	CPU fault 3 (cF3)
09	Hardware Protection Fault (HPF)
10	Over-current acceleration (ocA)
11	Over-current deceleration (ocd)
12	Over-current normal (ocn)
13	Ground and fuse fault (GFF)
14	Low voltage (Lv)
15	Low voltage 1 (Lv1)
16	CPU fault 2 (cF2)
17	Baseblock (bb)
18	Overload (oL2)
19, 20	Reserved

Character Delay Time and Response Delay Time

- **Character Delay Time**

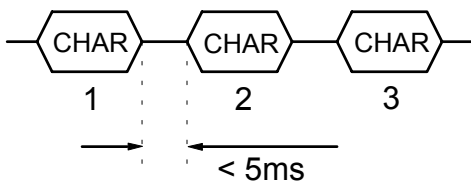

- **Response Delay Time**

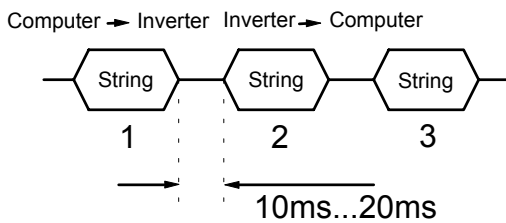

APPENDIX C

Dimensions

- VFD007A21A/H
 - VFD007A23A/H
 - VFD007A43A/H
 - VFD015A21A/H
 - VFD015A23A/H
 - VFD015A43B/H
- Unit: mm

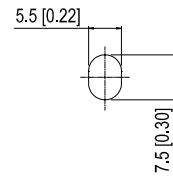
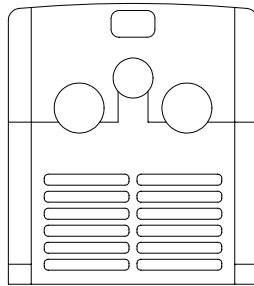
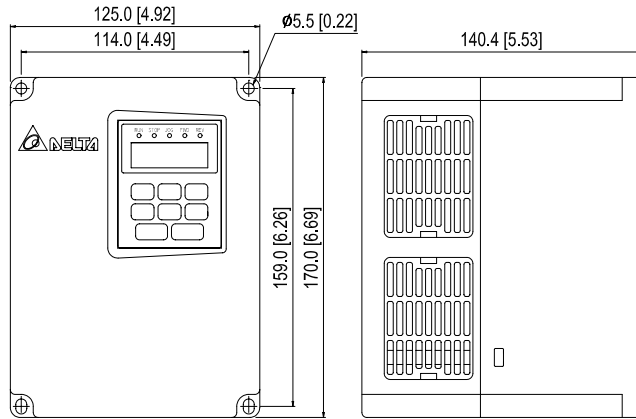

- VFD015A43A
 - VFD022A21A/H
 - VFD022A23A/H
 - VFD022A43A
 - VFD037A23A/H
 - VFD037A43A/H
- Unit: mm [inches]

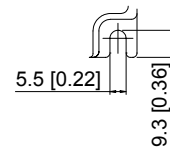
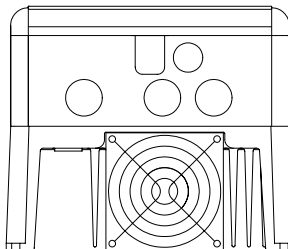
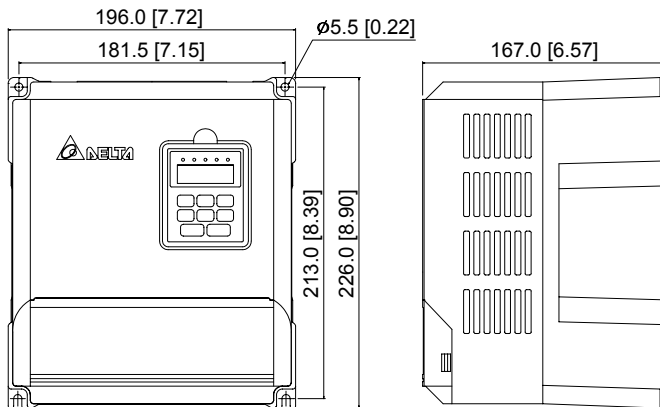

VFD055A23A/H
 VFD055A43A/H
 VFD075A23A/H
 VFD075A43A/H
 Unit: mm [inches]

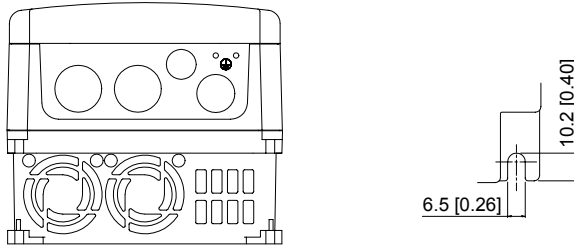
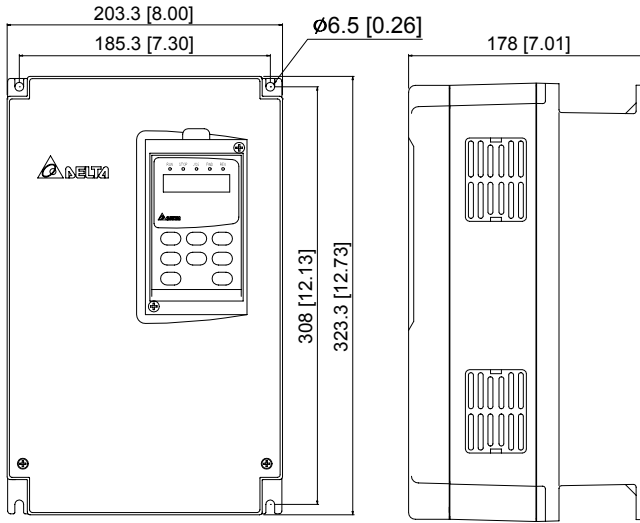

VFD110A23A/H
 VFD110A43A/H
 VFD150A23A/H
 VFD150A43A/H
 VFD185A23A/H
 VFD185A43A/H
 VFD220A23A/H
 VFD220A43A/H
 Unit: mm [inches]

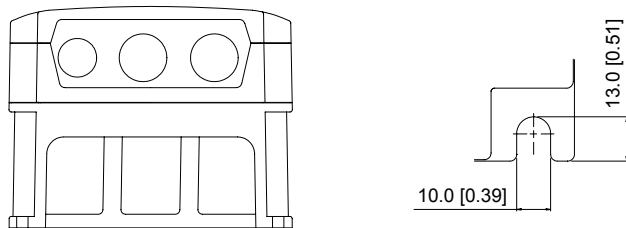
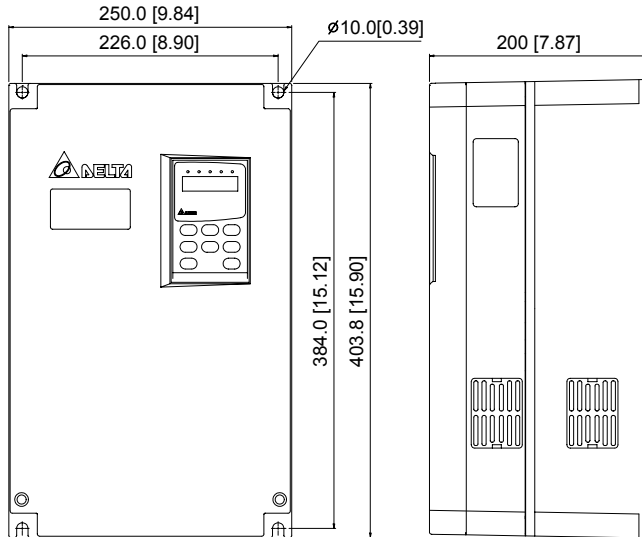

Digital Keypad

1. LC-A05E: it is used for A-Series 1HP~5HP

Unit: mm [inch]

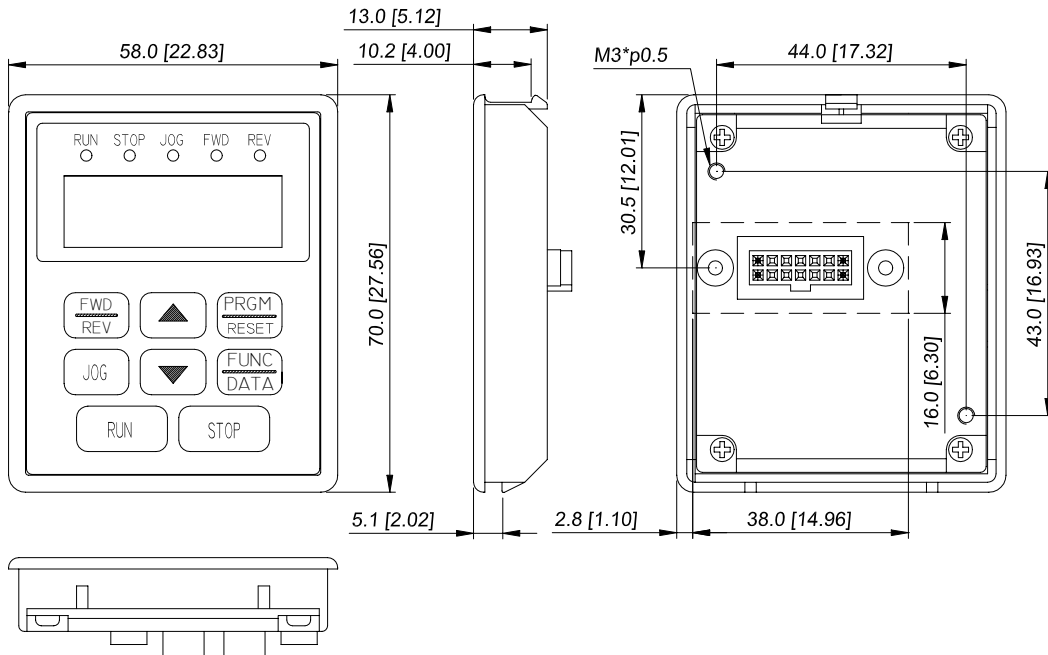

2. LC-A10E: it is used for A-Series 7.5HP~30HP

Unit: mm [inch]

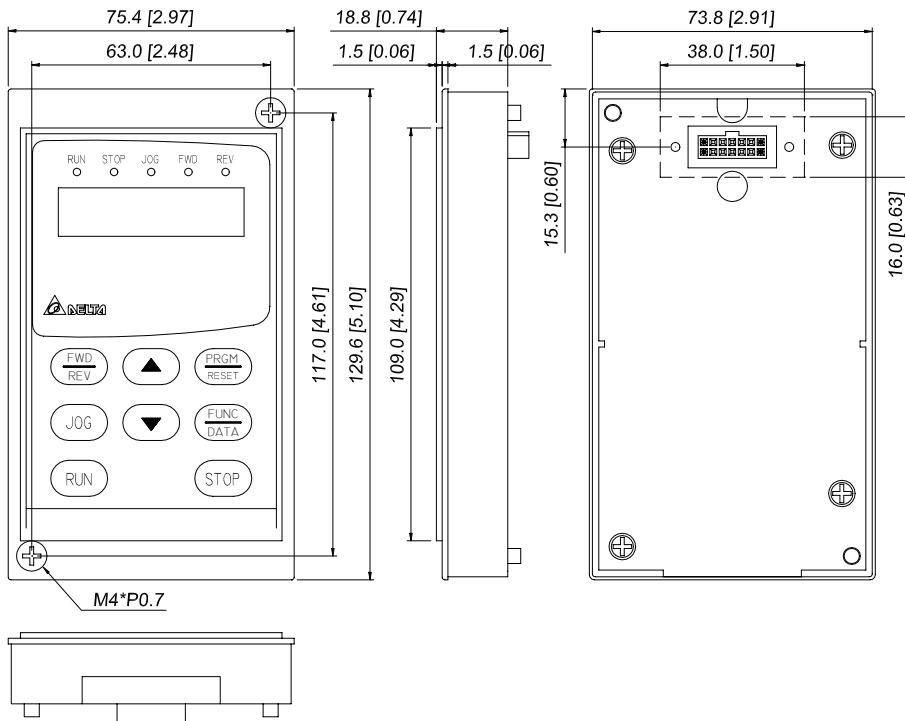

Remote Controller RC01 Adapter

Unit: mm [inches]

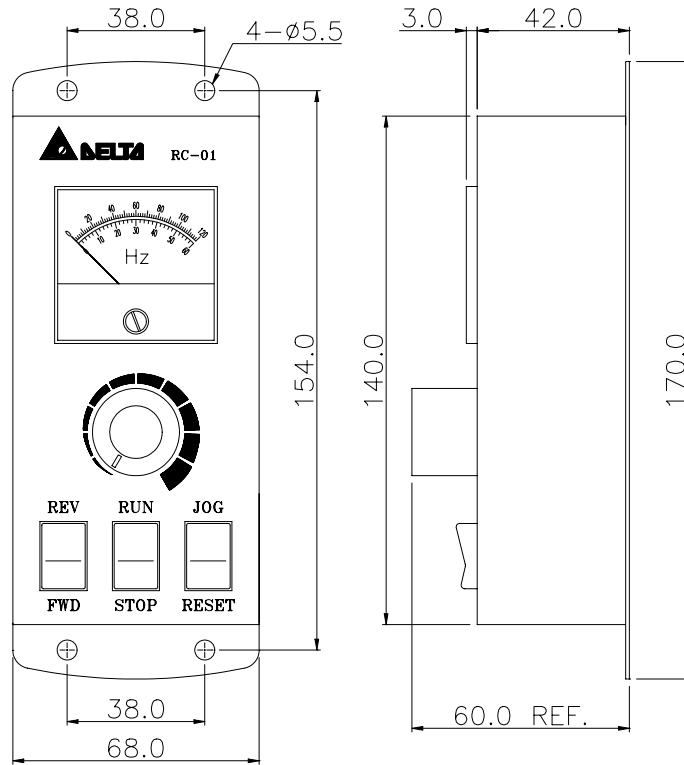

Standard Extension Cable

Unit: mm

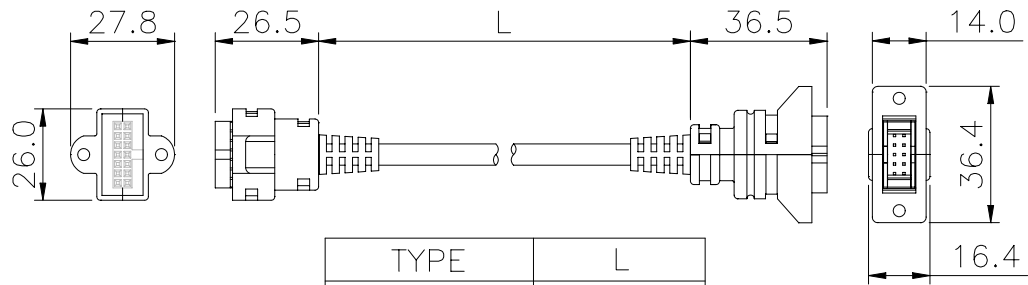

TYPE	L
EG0610A	600
EG1010A	1000
EG2010A	2000
EG3010A	3000
EG5010A	5000

All Braking Resistors & Braking Units Use in AC Drives

Note: Please only use DELTA resistors and recommended values. Other resistors and values will void Delta's warranty. Please contact your nearest Delta representative for use of special resistors. For instance, in 460 V series, 100 HP, AC drive has 2 braking units with total of 16 braking resistors, so each braking unit uses 8 braking resistors. There should be at least 10 cm away from AC drive to avoid possible noise. Refer to the "Braking Unit Module User Manual" for further detail.

Voltage	Applicable Motor		Full Load Torque KG-M	Specification of Resistors	Braking Unit Model VFDB No. of Unit Used		Braking Resistors Model No. of Units Used		Braking Torque 10%ED
	HP	kW							
230V Series	1/4	0.2	0.110	80W 200Ω			BR080W200	1	400
	1/2	0.5	0.216	80W 200Ω			BR080W200	1	220
	1	0.75	0.427	80W 200Ω			BR080W200	1	125
	2	1.5	0.849	300W 100Ω			BR300W100	1	125
	3	2.2	1.262	300W 70Ω			BR300W070	1	125
	5	3.7	2.080	400W 40Ω			BR400W040	1	125
	7.5	5.5	3.111	500W 30Ω			BR500W030	1	125
	10	7.5	4.148	1000W 20Ω			BR1K0W020	1	125
	15	11	6.186	2400W 13.6Ω	2015	1	BR1K2W6P8	2	125
	20	15	8.248	3000W 10Ω	2015	1	BR1K5W005	2	125
	25	18.5	10.281	4800W 8Ω	2022	1	BR1K2W008	4	125
	30	22	12.338	4800W 6.8Ω	2022	1	BR1K2W6P8	4	125
	40	30	16.497	6000W 5Ω	2015	2	BR1K5W005	4	125
	50	37	20.6	9600W 4Ω	2015	2	BR1K2W008	8	125
460V Series	1/4	0.2	0.110	80W 750Ω			BR080W750	1	300
	1/2	0.5	0.216	80W 750Ω			BR080W750	1	230
	1	0.75	0.427	80W 750Ω			BR080W750	1	125
	2	1.5	0.849	300W 400Ω			BR300W400	1	125
	3	2.2	1.262	300W 250Ω			BR300W250	1	125
	5	3.7	2.080	400W 150Ω			BR400W150	1	125
	7.5	5.5	3.111	500W 100Ω			BR500W100	1	125
	10	7.5	4.148	1000W 75Ω			BR1K0W075	1	125
	15	11	6.186	1000W 50Ω	4030	1	BR1K0W050	1	125
	20	15	8.248	1500W 40Ω	4030	1	BR1K5W040	1	125
	25	18.5	10.281	4800W 32Ω	4030	1	BR1K2W008	4	125
	30	22	12.338	4800W 27.2Ω	4030	1	BR1K2W6P8	4	125
	40	30	16.497	6000W 20Ω	4030	1	BR1K5W005	4	125
	50	37	20.6	9600W 16Ω	4045	1	BR1K2W008	8	125
60	45	24.745	9600W 13.6Ω	4045	1	BR1K2W6P8	8	125	
75	55	31.11	12000W 10Ω	4030	2	BR1K5W005	8	125	
100	75	42.7	19200W 6.8Ω	4045	2	BR1K2W6P8	16	125	

Braking Resistors & Braking Units

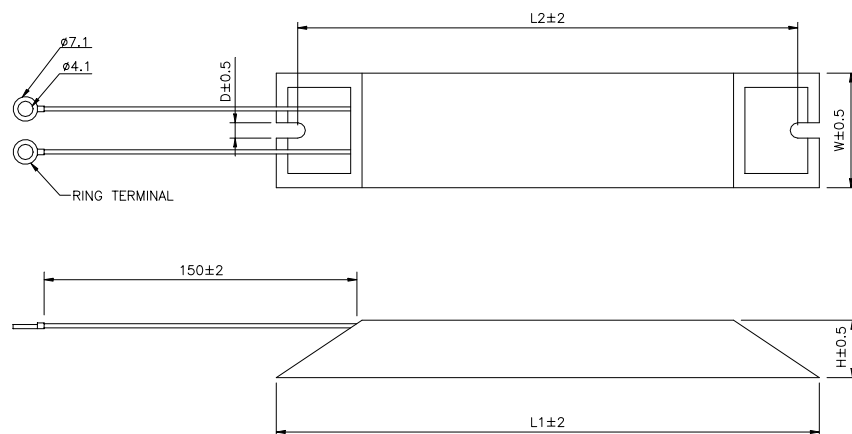

TYPE	L1	L2	H	D	W	MAX. WEIGHT (g)
MHR200W120	165	150	20	5.3	40	240
MHR400W120	165	150	20	5.3	40	240
BR080W200	140	125	20	5.3	60	160
BR080W750	140	125	20	5.3	60	160
BR300W070	215	200	30	5.3	60	750
BR300W100	215	200	30	5.3	60	750
BR300W250	215	200	30	5.3	60	750
BR300W400	215	200	30	5.3	60	750
BR400W150	265	250	30	5.3	60	930
BR400W040	265	250	30	5.3	60	930

Braking Resistors & Braking Units

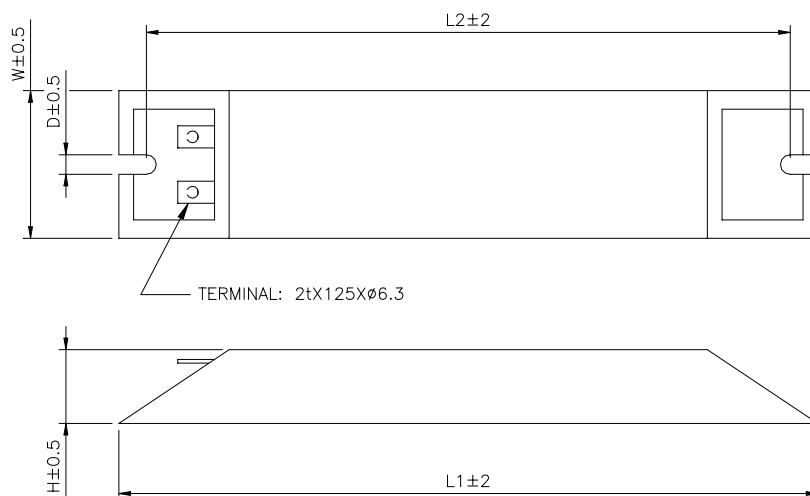

TYPE	L1	L2	H	D	W	MAX. WEIGHT (g)
MHR025W500	335	320	30	5.3	60	1100
MHR050W500	335	320	30	5.3	60	1100
MHR100W500	335	320	30	5.3	60	1100
BR500W030	335	320	30	5.3	60	1100
BR500W100	335	320	30	5.3	60	1100
BR1K0W020	400	385	50	5.3	100	2800
BR1K0W075	400	385	50	5.3	100	2800

Braking resistors model no.: BR1K0W050, BR1K2W008, BR1K2W6P8,
BR1K5W005, BR1K5W040

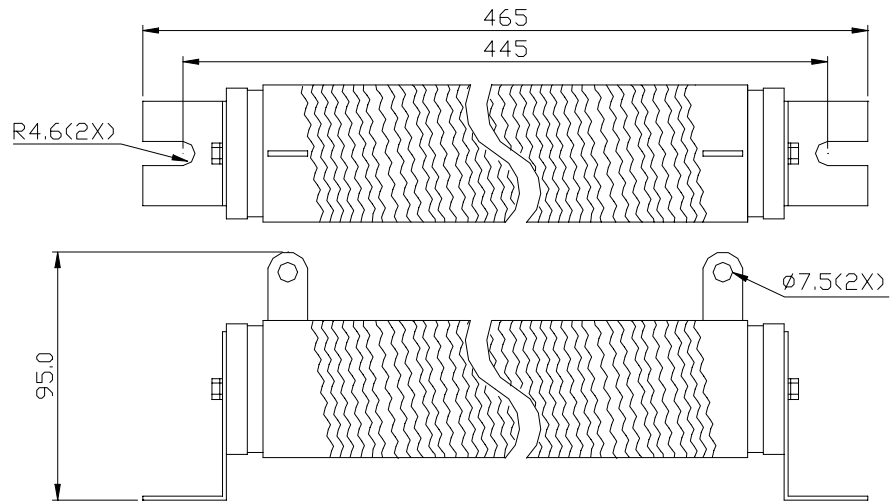

APPENDIX D

Accessories

Name	Model	Remarks
Remote control box	RC-01	Used the twisted shielded or twisted-pair shield.
Digital keypad	LC-A05E	Used for A-Series 1HP~5HP.
Digital keypad	LC-A10E	Used for A-Series 7.5HP~30HP.
Standard extension cable (0.6 M)	EG0610A	Used for A-Series 1~30HP, M-Series 0.5HP~2HP.
Standard extension cable (1 M)	EG1010A	Used for A-Series 1~30HP, M-Series 0.5HP~2HP.
Standard extension cable (2 M)	EG2010A	Used for A-Series 1~30HP, M-Series 0.5HP~2HP.
Standard extension cable (3 M)	EG3010A	Used for A-Series 1~30HP, M-Series 0.5HP~2HP.
Standard extension cable (5 M)	EG5010A	Used for A-Series 1~30HP, M-Series 0.5HP~2HP.
Braking resistor (400Ω120W)	MHR400W120	Used for 1, 2 HP / 440 V.
Braking resistor (200Ω120W)	MVR200W120	Used for 3, 5 HP / 440 V.
Braking resistor (200Ω200W)	MVR200W200	Used for 3, 5 HP / 440 V.
Braking resistor (200Ω120W)	MHR200W120	Used for 1, 2 HP / 220 V.
Braking resistor (80Ω120W)	MVR080W120	Used for 3 HP / 220 V.
Braking resistor (80Ω200W)	MVR080W200	Used for 3 HP / 220 V.
Braking resistor (50Ω120W)	MVR050W120	Used for 5 HP / 220 V.
Braking resistor (50Ω200W)	MVR050W200	Used for 5 HP / 220 V.
Braking resistor (25Ω500W)	MHR025W500	Used for 7.5~10 HP / 220 V.
Braking resistor (50Ω500W)	MHR050W500	Used for 7.5~10 HP / 220 V and 440 V.
Braking resistor (100Ω500W)	MHR100W500	Used for 7.5~10 HP / 440 V.
EMI CORE (22*14*8)	CTC221408A	Integrated by the wiring diameter
EMI CORE (31*19*13)	CTC311913A	Integrated by the wiring diameter
EMI CORE (51*31*13)	CTC513113A	Integrated by the wiring diameter
EMI CORE (68*44*13.5)	CTC684413B	Integrated by the wiring diameter

APPENDIX E

EMI Filters

The EC Declaration of Conformity for AC Motor Drives VFD-A Series 1-30HP was completed in conjunction of DELTA's EMI Filters. The correspondence of AC Motor Drives to EMI Filters is shown as below:

Model of AC Motor Drive	Model of EMI Filter	Spec. of EMI Filter
VFD007A21A, VFD015A21A	16DRT1W3A	220V, 1 ϕ , 16A
VFD007A23A, VFD007A43A, VFD015A23A, VFD015A43B,	10TDT1W4	220V/440V, 3 ϕ , 10A
VFD022A21A	30DRT1W3	220V, 1 ϕ , 30A
VFD022A43A, VFD037A43A	10TDT1W4B	440V, 3 ϕ , 10A
VFD022A23A, VFD037A23A	20TDT1W4	220V, 3 ϕ , 20A
VFD055A43B, VFD075A43B	21TDT1W4	440V, 3 ϕ , 21A
VFD055A23B, VFD075A23B, VFD110A23A, VFD110A43A, VFD150A43A, VFD185A43A, VFD220A43A	50TDS4W4	220V/440V, 3 ϕ , 50A
VFD150A23A, VFD185A23A, VFD220A23A	100TDS8A	220V, 3 ϕ , 100A

If the users need to operate the AC Motor Drives VFD-A Series with DELTA's EMI Filters, the suitable models can be determined from the above table.

EC Declaration of Conformity



DELTA ELECTRONICS, INC.

EC Declaration of Conformity According to the Low Voltage Directive 73/23/EEC and the Amendment Directive 93/68/EEC

For the following equipment:

AC Motor Drive

(Product Name)

VFD007A21A, VFD007A23A, VFD007A43A, VFD015A21A, VFD015A23A, VFD015A43A,
VFD015A43B, VFD022A21A, VFD022A23A, VFD022A43A, VFD037A23A, VFD037A43A,
VFD055A23B, VFD055A43B, VFD075A23B, VFD075A43B, VFD110A23A, VFD110A43A,
VFD150A23A, VFD150A43A, VFD185A23A, VFD185A43A, VFD220A23A, VFD220A43A

(Model Name)

is herewith confirmed to comply with the requirements set out in the Council Directive 73/23/EEC for electrical equipment used within certain voltage limits and the Amendment Directive 93/68/EEC. For the evaluation of the compliance with this Directive, the following standard was applied:

EN 50178

The following manufacturer/importer is responsible for this declaration:

Delta Electronics, Inc.

(Company Name)



DELTA ELECTRONICS, INC.

EC Declaration of Conformity
According to the Electromagnetic Compatibility 89/336/EEC and the
Amendment Directive 93/68/EEC

For the following equipment:

AC Motor Drive

(Product Name)

VFD007A21A, VFD007A23A, VFD007A43A, VFD015A21A, VFD015A23A, VFD015A43A,
VFD015A43B, VFD022A21A, VFD022A23A, VFD022A43A, VFD037A23A, VFD037A43A,
VFD055A23B, VFD055A43B, VFD075A23B, VFD075A43B, VFD110A23A, VFD110A43A,
VFD150A23A, VFD150A43A, VFD185A23A, VFD185A43A, VFD220A23A, VFD220A43A

(Model Designation)

is herewith confirmed to comply with the requirements set out in the Council Directive 89/336/EEC for electromagnetic compatibility and the Amendment Directive 93/68/EEC. For the evaluation of the compliance with this Directive, the following standard was applied:

EN61800-3, EN55011, EN61000-4-2, EN61000-4-3, EN61000-4-4, EN61000-4-5,
EN61000-4-6, EN61000-4-8

The following manufacturer/importer is responsible for this declaration:

Delta Electronics, Inc.

(Company Name)

APPENDIX G

Non-fuse Circuit Breaker Chart

Per UL 508C, paragraph 44.8.6, part a,

1. For 1-phase drives, the current rating of the breaker shall be four times Max. of input current rating.
2. For 3-phase drives, the current rating of the breaker shall be four times Max. of output current rating.

(Note: Please select enough current capacity of NFB.)

1-phase		3-phase			
Model	Input Current (A)	Model	Output Current (A)	Model	Output Current (A)
VFD007A21A	11	VFD007A23A	5.0	VFD075A23B	33
VFD015A21A	15	VFD007A43A	3.0	VFD075A43B	18
VFD022A21A	27	VFD015A23A	6.5	VFD110A23A	46
		VFD015A43A	4.2	VFD110A43A	24
		VFD015A43B	4.2	VFD150A23A	60
		VFD022A23A	11	VFD150A43A	32
		VFD022A43A	5.5	VFD185A23A	75
		VFD037A23A	17	VFD185A43A	38
		VFD037A43A	8.2	VFD220A23A	87
		VFD055A23B	25	VFD220A43A	45
		VFD055A43B	13		

Fuse Specification Chart

Smaller fuses than those shown in the table are permitted.

Model	Input Current (A)	Output Current (A)	Line Fuse	
			I (A)	Bussmann P/N
VFD007A21A	11	5.0	40	JJN-40
VFD007A23A	7.4	5.0	20	JJN-20
VFD007A43A	4.2	3.0	10	JJS-10
VFD015A21A	15	6.5	60	JJN-60
VFD015A23A	9.9	6.5	25	JJN-25
VFD015A43A	6	4.2	15	JJS-15
VFD015A43B	5.8	4.2	15	JJS-15
VFD022A21A	27	11	100	JJN-100
VFD022A23A	15.5	11	40	JJN-40
VFD022A43A	7.2	5.5	20	JJS-20
VFD037A23A	19.6	17	60	JJN-60
VFD037A43A	8.5	8.2	30	JJS-30
VFD055A23B	33.5	25	100	JJN-100
VFD055A43B	14	13	50	JJS-50
VFD075A23B	43.3	33	125	JJN-125
VFD075A43B	20.6	18	70	JJS-70
VFD110A23A	46	46	175	JJN-175
VFD110A43A	28	24	90	JJS-90
VFD150A23A	76	60	225	JJN-225
VFD150A43A	30	32	125	JJS-125
VFD185A23A	83	75	300	JJN-300
VFD185A43A	39	38	150	JJS-150
VFD220A23A	99	87	340	JJN-300
VFD220A43A	49	45	175	JJS-175